

XAL 23

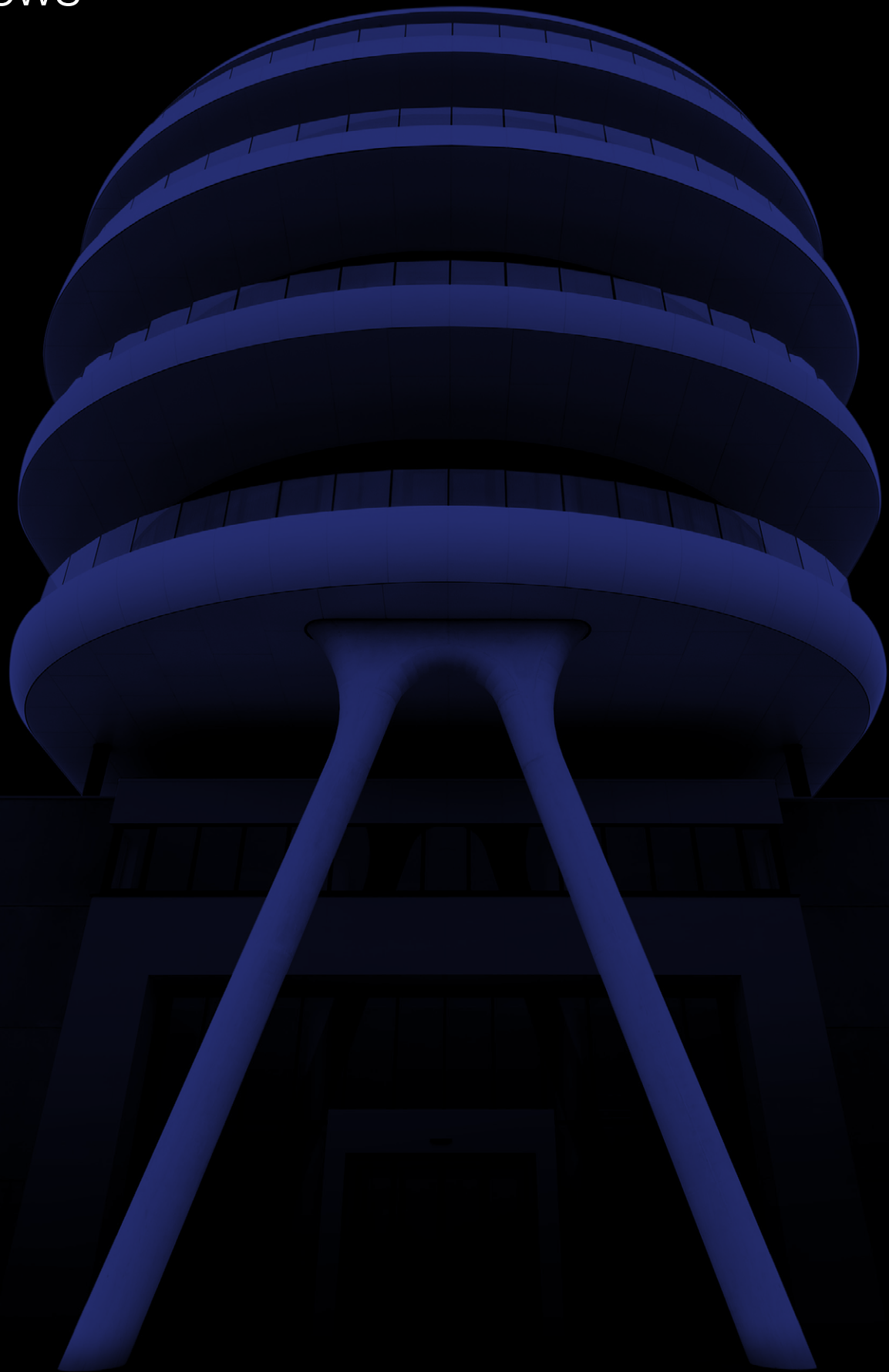

EN ES

News





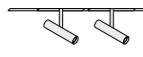
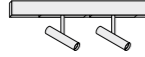

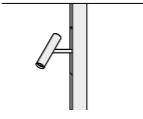
# Contents

**MOVE IT 10**  
installation track

				
recessed trimless	surface square	suspended square	suspended round	pole square/round
<b>12</b>	<b>12</b>	<b>14</b>	<b>14</b>	<b>16</b>

linear insets

			
SPOT LINE direct	OPAL direct	DARKLIGHT direct	indirect
<b>20</b>	<b>20</b>	<b>20</b>	<b>20</b>

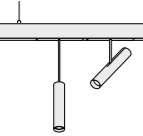
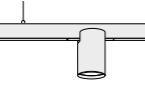
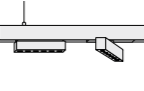
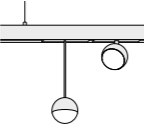

decorative insets

			
TILA	TARO	GIRA	NOBA
<b>24</b>	<b>32</b>	<b>36</b>	<b>40</b>

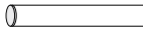
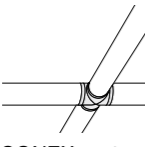
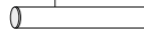
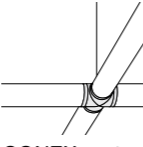
**TUBO 60**  
surface

		suspended		
system	CONEX system		system	CONEX system
<b>48</b>	<b>48</b>		<b>48</b>	<b>48</b>

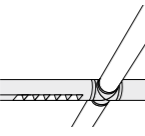

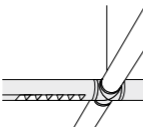

**SETA**  
ceiling

		suspended		
system	CONEX system		system	CONEX system
<b>48</b>	<b>48</b>		<b>48</b>	<b>48</b>

**MITA**  
ceiling

	suspended	
circle		suspended
<b>58</b>		<b>64</b>

**SPIO**  
recessed

			
20 downlight	20 wallwasher	60 downlight	60 adjustable
<b>72</b>	<b>72</b>	<b>76</b>	<b>76</b>

**SQUADRO**  
recessed

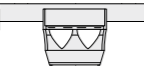
	track	
wallwasher		wallwasher
<b>84</b>		<b>88</b>

**BO**  
intrack

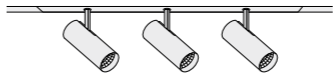
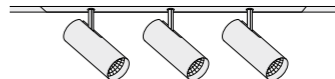
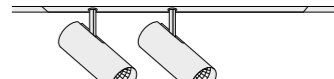
		
32 2/3 lamps	45 2/3 lamps	55 1/2 lamps
<b>96</b>	<b>96</b>	<b>96</b>

**VARO**  
track

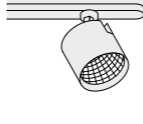
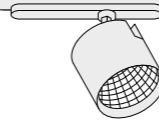
	
80 S	110 S
<b>104</b>	<b>108</b>

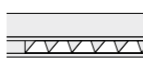

**MILA**  
ceiling

system
<b>116</b>

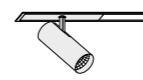
**FRAME 40**  
recessed trim

	
system	system
<b>124</b>	<b>130</b>

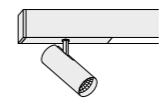
**MINO 40**  
ceiling

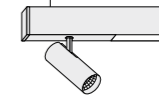
		suspended		
system	system		40 system	40 system
<b>128</b>	<b>130</b>		<b>128</b>	<b>130</b>





















# Elegance on track



## MOVE IT 10 system

**EN** MOVE IT 10 is a particularly slim track system. The dimmable low-voltage track, available as a recessed, surface-mounted, suspended or pole version, is impressive thanks to its unusually slender cross-section. Both the round and square forms have a clear width of only 10 mm. MOVE IT 10's design is minimalistic. The insets' adapter are fully hidden in the track. The tracks are available in black, white and chrome (standard for the round version). They are connected by Corner or Curve elements for an edgy or softly rounded appearance. Extend MOVE IT 10 with various linear or design-oriented insets for maximum planning freedom for your interior concept.

**ES** Un carril electrificado ultrafino: eso es MOVE IT 10. Este sistema de carril atenuable de baja tensión está disponible en variantes empotrables, suspendidas, de montaje en superficie o de poste, y destaca por su sección extraordinariamente delgada: ya sea en forma redonda o rectangular, su anchura mínima es de tan solo 10 mm. El diseño minimalista continúa en los adaptadores que desaparecen por completo en los carriles, los cuales están disponibles en los colores negro, blanco y cromo (en la variante redonda) y se conectan con elementos Corner o Curve para formar esquinas bien definidas o curvas suaves. MOVE IT 10 puede ampliarse con distintos insertos lineales o adaptados al diseño específico para ofrecer la máxima libertad de planificación en cualquier diseño interior.

<b>Types</b>							
	square	round					
<b>Mountings</b>							
	recessed	surface	suspended	pole			
<b>Configurations</b>							
	linear	curve	L- connector	T- connector	X- connector	level connector	ceiling to wall connector
<b>Light distributions</b>							
	spot line	opal	darklight	spotlight	decorative	wallwasher floor	direct indirect

## Mounting options

**EN** Depending on the desired appearance and installation, the 48V track system is available as a trimless recessed-mounted, surface-mounted, suspended or pole version.

**ES** En función del aspecto y el montaje deseados, el sistema de carril eléctrico de 48V está disponible en una variante empotrable sin marco, en una versión de superficie, en un modelo suspendido y como variante de poste.



## Create individual arrangements

**EN** Let your creativity run wild and arrange MOVE IT 10 at will. Special Curve and Corner elements enable the straight tracks to be connected to form harmonious curves or precise corners. Since all elements fit together, you can configure your ideal bespoke system.

**ES** Dé rienda suelta a su creatividad y configure el sistema MOVE IT 10 del modo que prefiera. Los elementos especiales Curve y Corner permiten combinar los carriles rectilíneos formando curvas armoniosas o esquinas de trazado preciso. Dado que todos los elementos encajan unos con otros, podrá configurar el sistema de manera personalizada adaptándolo a sus deseos y al espacio disponible.

## Track shapes

**EN** In both the round and square form, the track opens options for flexible application. Their track diameter is only 29 mm, presenting a reduced and sleek appearance. Many insets offer an optional flush adapter to create an even, visually calm ceiling appearance.

**ES** El carril eléctrico ofrece posibilidades de uso flexibles en sus formas redonda y rectangular. Su limitado diámetro de hasta 29 mm le confiere una apariencia minimalista de gran calidad. Numerosos insertos luminosos cuentan con un adaptador embutido que genera un patrón de techo plano y tranquilo desde el punto de vista visual.

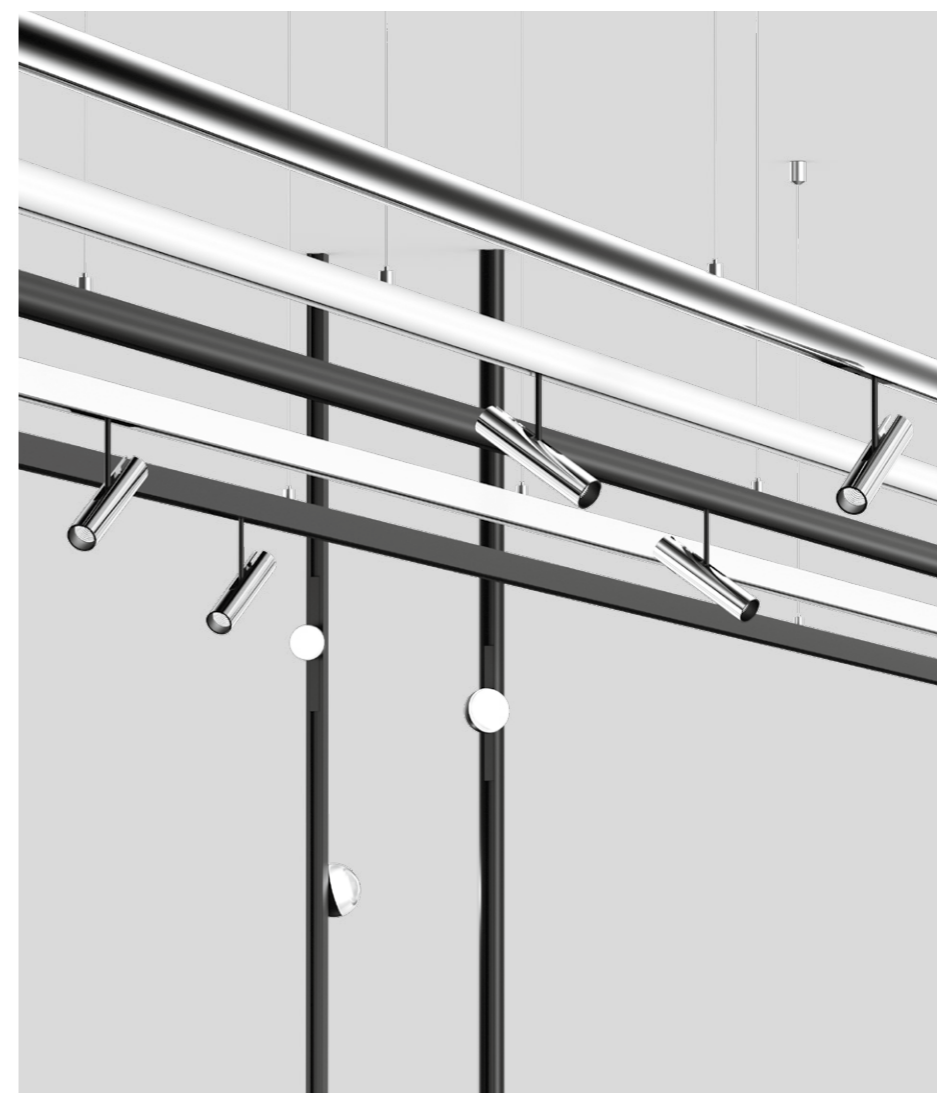
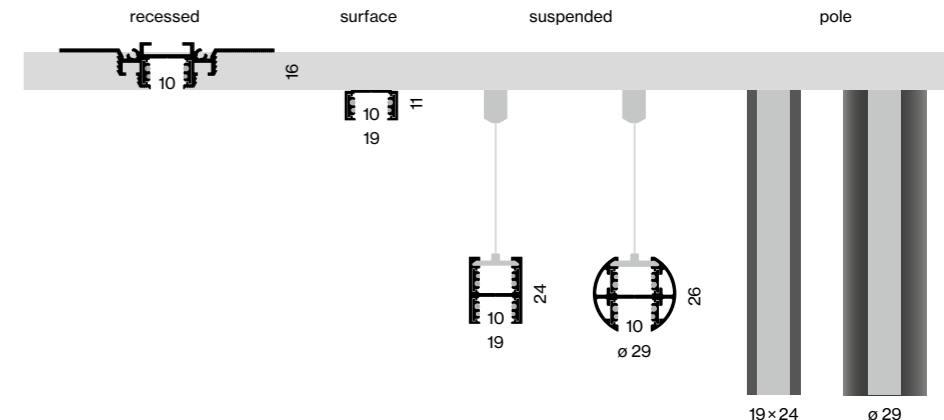

## Colour variety

**EN** The tracks are available in the colours black and white, delivering discreet elegance. The round track comes additionally in chrome. In addition, for some insets you have the choice between the trend colours chrome, rose gold, gun metal, brushed aluminium and brushed brass.

**ES** Elegancia discreta: los carriles eléctricos están disponibles en los colores negro y blanco. El carril redondo también se ofrece en cromo. Además, algunos insertos están disponibles en los colores especiales cromo, Rosé Gold, Gun Metal, aluminio cepillado y latón cepillado.

### Installation tracks

recessed square	●
surface square	○
suspended square	○
suspended round	○
pole square	○
pole round	○

### Decorative insets

GIRA	○	●	○	●	○	●
NOBA	○	●	○	●	○	●
TARO	○	●	○	●	○	●
TILA	○	●	○	●	○	●

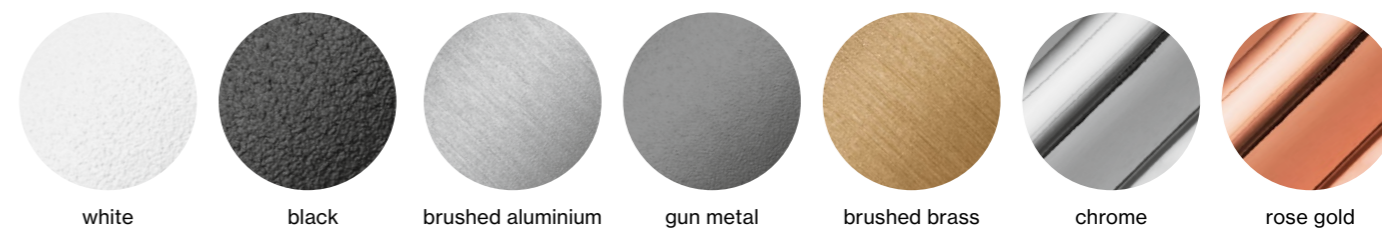



## Mounting variety

**EN** With precise corners or harmonious curves, the MOVE IT 10 system sets no limits to creativity. Elegant insets for different applications make the track system even more flexible.

**ES** Ya se trate de definir esquinas precisas o de crear curvas armoniosas, el sistema MOVE IT 10 no pone límites a su creatividad. Los insertos elegantes para diferentes aplicaciones hacen que el sistema de carril sea aún más flexible en el uso.

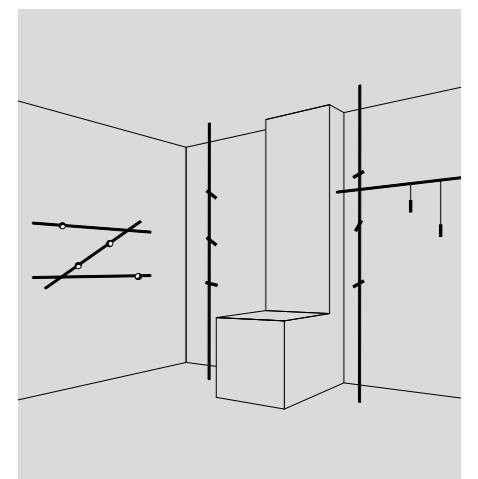
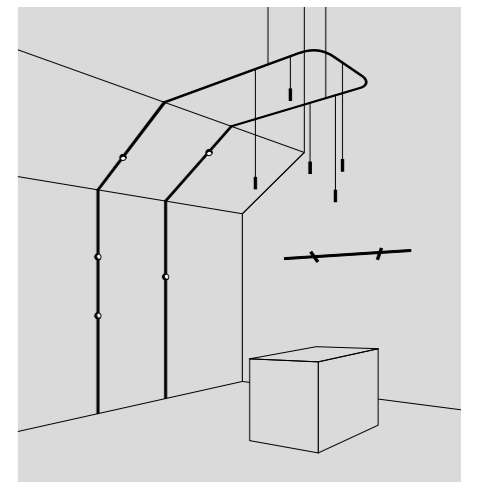
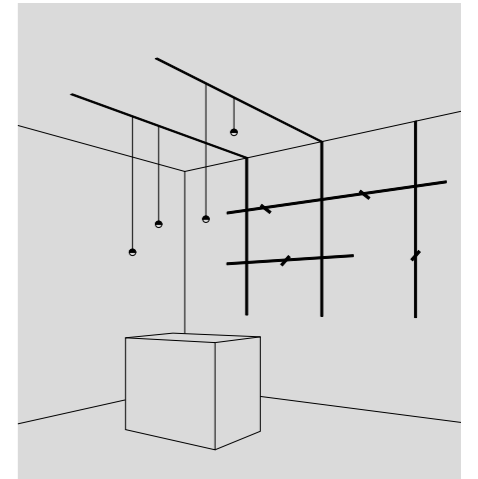

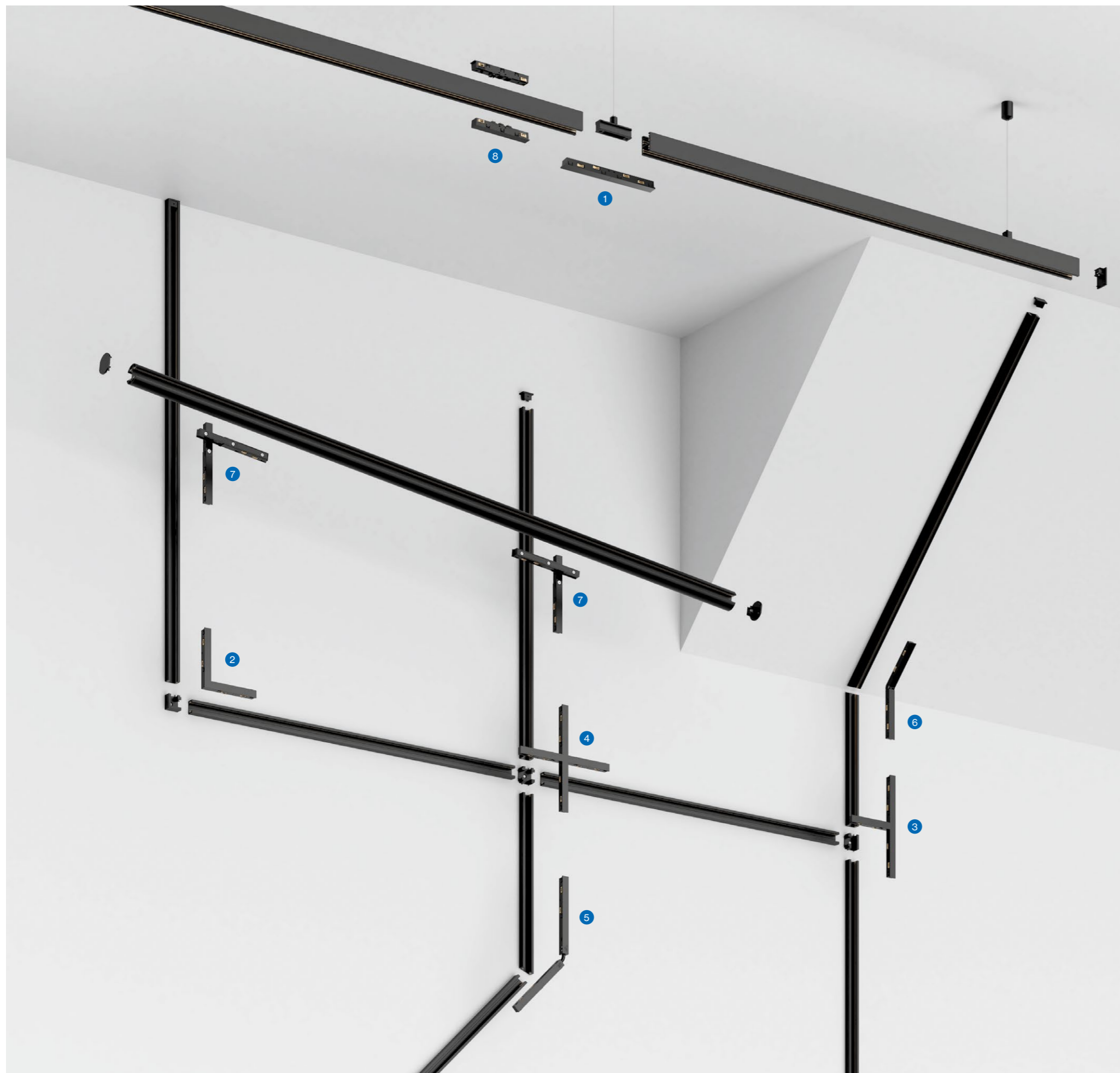

## Connector overview

**EN** A large selection of different connectors – in L-, T-, X-shape – provides even more flexibility. With the Ceiling to Wall Connector, roof slopes with different angles can also be realised.

**ES** La amplia variedad de conectores distintos –en forma de L, T o X– proporciona aún mayor flexibilidad. Con el conector Ceiling to Wall es posible crear además inclinaciones de techo a ángulos distintos.

**1 Linear Connector**



**2 L-Connector**



**3 T-Connector**



**4 X-Connector**



**5 Flex Connector**

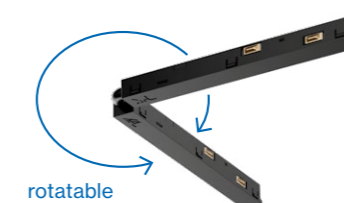

**6 Ceiling to Wall Connector**

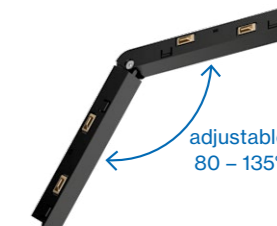

**7 Level Connector**



**8 Pass Through Connector**



**EN** With the Level Connector, two tracks that are placed on top of each other can now be mechanically and electrically connected to each other. This creates new application possibilities.

**EN** With the Pass Through Connector (patent pending) the direct and indirect light insets in the H-track can be electrically connected to each other.

**ES** El conector Level permite conectar mecánica y eléctricamente entre sí dos carriles que discurren el uno sobre el otro. Esto ofrece posibilidades de uso nuevas y fascinantes.

**ES** Con el conector «pass-through» –en espera de patente– es posible conectar entre sí eléctricamente los insertos de luz directa e indirecta en el carril H.

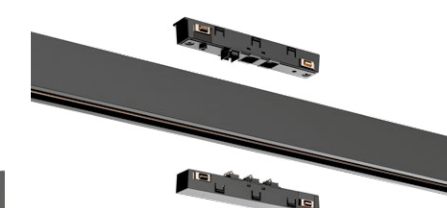
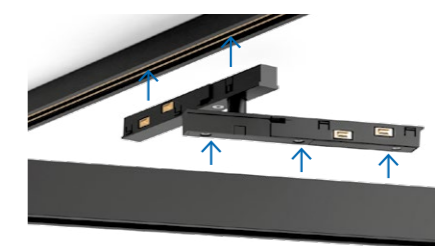



## MOVE IT 10 system

recessed trimless/surface

Thin extruded aluminium profile with 16 mm (trimless) or 11 mm (surface) height and 10 mm width groove; optionally for trimless installation in plasterboard ceilings (wall or ceiling mounting) with 12.5mm ceiling thickness; MOVE IT 10 trimless profile with processing protection against penetration of filler; or for wall-/ceiling surface mounting; designed for continuous lighting systems; flexible system design through L, T or X connectors or by means of FLEX or LEVEL connectors; with integrated power track profile for take off of supply voltage and DALI-2 signal; surface anodised or powder coated; insets can be installed flexibly and without tools by means of clip mount

Perfil bajo de aluminio extruido con 16 mm (trimless) o 11 mm (surface) de altura y 10 mm de anchura de junta; disponible para el encastre sin bordes en techos de cartón yeso (montaje en pared o techo) de 12,5 mm de espesor; perfil MOVE IT 10 trimless con protección contra la penetración de masilla; o para montaje sobre pared/techo; diseñado para la creación de sistemas continuos; montaje flexible del sistema con conectores en forma de L, T o X y conectores FLEX o LEVEL; con perfil de rail electrificado integrado para la recepción de la tensión de alimentación y DALI-2; superficie anodizada o recubierto de polvo; montaje flexible y sin herramienta de los insertos con cierre de clip

### Quickinfo

2700K, 3000K, 4000K  
CRI ≥ 90  
L90 @ 50 000h  
DALI-2

### Types

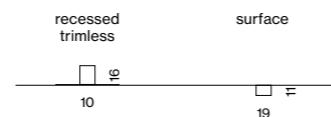

### Configurations

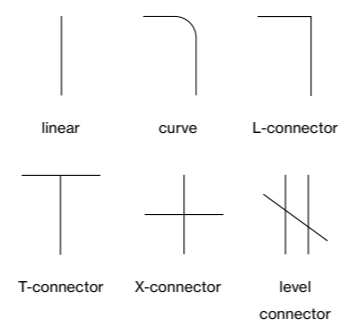

### Colours

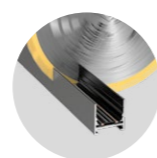

custom cut on building site

### Order options

**CONTROL**  
DALI-2

### MATERIAL COLOUR

- traffic white RAL 9016 7
- jet black RAL 9005 8

### Options on request

#### CONNECTOR

- T connector mechanical
  - T connector electrical
  - X connector mechanical
  - X connector electrical
- only for recessed trimless

### MOVE IT 10 trimless



#### INSTALLATION TRACK

L (mm)

1100	channel
2100	channel
3100	channel
custom cut	channel

\*incl. plasterin protection cover

#### END CAPS / CONNECTORS

TYPE

end caps (pair)	
linear connector electrical	
L connector electrical	
linear connector mechanical	
L connector mechanical	

more electrical and mechanical connectors see p. 19

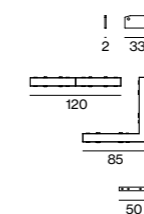

ORDER CODE

030-1113038
030-1115038
030-1117038
E83610

### MOVE IT 10 surface

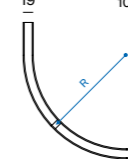

#### INSTALLATION TRACK

L (mm)

1100	channel
2100	channel
3100	channel
custom cut	channel
R 300	curve channel
R 500	curve channel

#### END CAPS / CONNECTORS

TYPE

end caps (pair)	
linear connector electrical	
L connector electrical	
T connector electrical	
X connector electrical	
linear connector mechanical	
L connector mechanical	
T connector mechanical	
X connector mechanical	

more electrical and mechanical connectors see p. 19

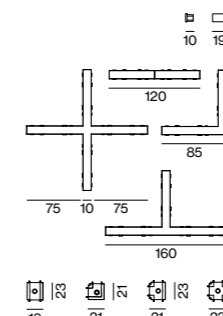

ORDER CODE

030-121303
030-121503
030-121703
E83620
030-123103
030-123203

### Accessories

#### BLIND COVER

L (mm)

1100	blind cover
2100	blind cover
3100	blind cover
custom cut	blind cover

#### ELECTRICAL ACCESSORIES

TYPE

power feeder (only for surface)	
internal power feeder (incl. cable 2000mm)	

more electrical and mechanical connectors see p. 19

ORDER CODE

030-100301
030-100501
030-100701
E83600
030-252303
030-252503

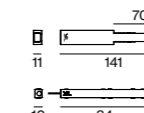



## MOVE IT 10 system

suspended

EN Thin extruded aluminium profile with 10 mm width groove; choice of angular (38 mm height) or tubular (28 mm height) design; for suspended mounting (cable suspension, height adjustment without tools, incl. black feed); with integrated power track profile on both sides for take off of supply voltage and DALI-2 signal; power supply and DALI-2 signal for both power tracks with only one feed by means of pass-through connector; designed for continuous lighting systems; flexible system design through L, T or X connectors or by means of LEVEL connectors; surface anodised or powder coated; insets can be installed flexibly and without tools by means of clip mount

ES Perfil bajo de aluminio extruido con 10 mm de anchura de junta; disponible en forma angular (38 mm de altura) o tubular (28 mm de altura); para montaje suspendido (suspensión por cable, ajuste de altura sin herramienta, cable de alimentación negro incluido); con perfil de carril electrificado incorporado en ambos lados para la toma de suministro eléctrico y señal DALI-2; suministro eléctrico y señal DALI-2 para ambos carriles electrificados con una sola toma de alimentación mediante conector pass-through; diseñado para la creación de sistemas continuos; montaje flexible del sistema con conectores en forma de L, T o X y conectores LEVEL; superficie anodizada o recubierto de polvo; montaje flexible y sin herramienta de los insertos con cierre de clip



### Quickinfo

2700K, 3000K, 4000K  
CRI ≥ 90  
L90 @ 50 000h  
DALI-2

### Types

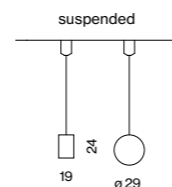

### Configurations

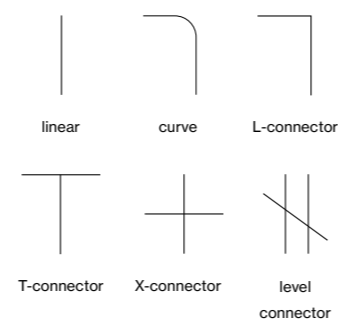

### Colours



### Order options

**CONTROL**  
DALI-2

**MATERIAL COLOUR**   
 ○ traffic white RAL 9016 7  
 ● jet black RAL 9005 8

**MATERIAL COLOUR**  
**CABLE SUSPENSION**   
 ● chrome 4  
 ● jet black RAL 9005 8

### Options on request

**MATERIAL COLOUR**  
**MOVE IT 10 ROUND**  
 ● chrome

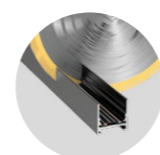

custom cut on building site

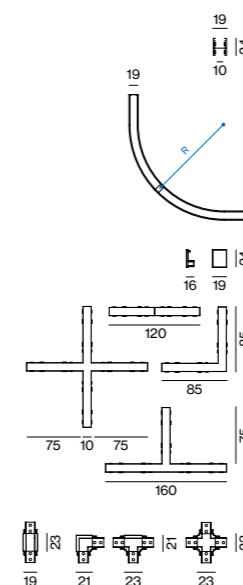

### MOVE IT 10 square suspended



#### INSTALLATION TRACK

L (mm)		ORDER CODE
1100	channel	030-131303
2100	channel	030-131503
3100	channel	030-131703
custom cut	channel	E83630
R 300	curve channel	030-133103
R 500	curve channel	030-133203

#### END CAPS / CONNECTORS

TYPE	ORDER CODE
end caps (pair)	030-132001
linear connector electrical	030-210113
L connector electrical	030-211113
T connector electrical	030-212113
X connector electrical	030-213113
linear connector mechanical	030-133401
L connector mechanical	030-133501
T connector mechanical	030-133601
X connector mechanical	030-133701

more electrical and mechanical connectors see page 19

### MOVE IT 10 round suspended



#### INSTALLATION TRACK

L (mm)		ORDER CODE
1100	channel	030-141303
2100	channel	030-141503
3100	channel	030-141703
custom cut	channel	E83640
R 300	curve channel	030-143103
R 500	curve channel	030-143203

#### END CAPS / CONNECTORS

TYPE	ORDER CODE
end caps (pair)	030-142001
linear connector electrical	030-210113
L connector electrical	030-211113
T connector electrical	030-212113
X connector electrical	030-213113
linear connector mechanical	030-143401
L connector mechanical	030-143501
T connector mechanical	030-143601
X connector mechanical	030-143701

more electrical and mechanical connectors see page 19

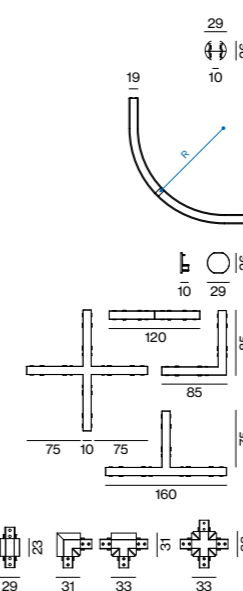

### Accessories

**BLIND COVER** see page 17

**INDIRECT LIGHT INSET** see page 17

#### CABLE SUSPENSION / CANOPY / ELECTRICAL ACCESSORIES

TYPE	L (mm)	ORDER CODE
cable suspension	1500	030-223001
cable susp. linear connector	1500	030-221001
cable susp. linear conn. electrical	1500	030-222001
canopy square	90-90-22	005-231121
canopy round	∅90-22	005-260003
internal power feeder (incl. cable 2000mm)		030-252503
pass through connector electrical (pair)		030-217113

more electrical and mechanical connectors see page 19







## MOVE IT 10 system

pole

Thin extruded aluminium profile with 10 mm width groove; choice of angular (38 mm height) or tubular (28 mm height) design; for vertical and horizontal mounting; easy installation of the mounting set, incl. feed; with integrated power track profile on both sides for take off of supply voltage and DALI-2 signal; power supply and DALI-2 signal for both power tracks with only one feed by means of pass-through connector; designed for continuous lighting systems; flexible system design through L, T or X connectors or by means of LEVEL connectors; surface anodised or powder coated; insets can be installed flexibly and without tools by means of clip mount

Perfil bajo de aluminio extruido con 10 mm de anchura de junta; disponible en forma angular (38 mm de altura) o tubular (28 mm de altura); para montaje en vertical y en horizontal; instalación sencilla del kit de montaje, incl. toma de alimentación; con perfil de carril electrificado incorporado en ambos lados para la toma de suministro eléctrico y señal DALI-2; suministro eléctrico y señal DALI-2 para ambos carriles electrificados con una sola toma de alimentación mediante conector pass-through; diseñado para la creación de sistemas continuos; montaje flexible del sistema con conectores en forma de L, T o X y conectores LEVEL; superficie anodizada o recubierto de polvo; montaje flexible y sin herramienta de los insertos con cierre de clip

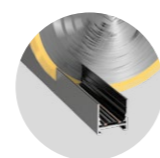

custom cut on building site

### Quickinfo

2700K, 3000K, 4000K  
CRI ≥ 90  
L90 @ 50 000h  
DALI-2

### Types

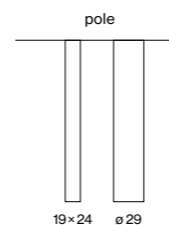

### Mounting types

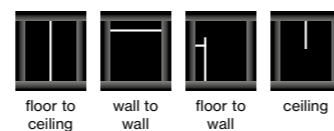

### Colours



### Order options

COLOUR TEMPERATURE	
2700K	4
3000K	5
4000K	6

### CONTROL

DALI-2

### MATERIAL COLOUR

○ traffic white RAL 9016	7
● jet black RAL 9005	8

### Options on request

MATERIAL COLOUR  
MOVE IT 10 ROUND

chrome

### MOVE IT 10 square pole

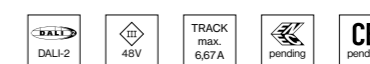

19  
H  
10

#### INSTALLATION TRACK

L (mm)		ORDER CODE
1100	channel	030-131303
2100	channel	030-131503
3100	channel	030-131703
custom cut	channel	E83630

19x24  
H  
46

#### MOUNTING SET

TYPE	ORDER CODE
floor to ceiling set (pair)	030-134101
wall to wall set (pair)	030-134101
floor to wall set (wall bracket 400mm incl. end cap)	030-134201
ceiling set (incl. end cap)	030-134301

### MOVE IT 10 round pole

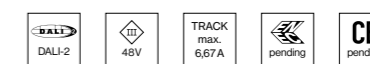

29  
H  
10

#### INSTALLATION TRACK

L (mm)		ORDER CODE
1100	channel	030-141303
2100	channel	030-141503
3100	channel	030-141703
custom cut	channel	E83640

29  
H  
46

#### MOUNTING SET

TYPE	ORDER CODE
floor to ceiling set (pair)	030-144101
wall to wall set (pair)	030-144101
floor to wall set (wall bracket 400mm incl. end cap)	030-144201
ceiling set (incl. end cap)	030-144301

### LIGHT INSET 10

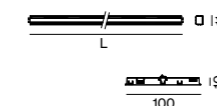

#### INDIRECT incl. feeder

INS. POWER	COLOUR TEMP.	LUM. FLUX	L (mm)	ORDER CODE
15 W	2700 K	1370 lm	1000	030-6330::38B
	3000 K	1450 lm		
	4000 K	1530 lm		
30 W	2700 K	2750 lm	2000	030-6370::38B
	3000 K	2900 lm		
	4000 K	3050 lm		

### Accessories

#### BLIND COVER

L (mm)		ORDER CODE
1100	blind cover	030-100301
2100	blind cover	030-100501
3100	blind cover	030-100701
custom cut	blind cover	E83600

#### ELECTRICAL ACCESSORIES

TYPE	ORDER CODE
internal power feeder (incl. cable 2000 mm)	030-252503
pass through connector electrical (pair)	030-217113

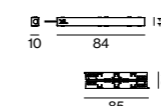

INSET POWER is the current consumption excluding any ballast  
LUMINOUS FLUX value calculated for CRI ≥ 90, colour black



## ELECTRICAL accessories

MOVE IT 10 system

**EN** Mechanical and electrical connectors to MOVE IT 10 system; in L-, T- or X-shape; or FLEX, CEILING TO WALL or LEVEL connectors, as well as PASS THROUGH connectors; for flexible system design; different converters for the entire MOVE IT system

**ES** Conectores mecánicos y eléctricos para MOVE IT 10 system; en forma de L, T o X; o conectores FLEX, CEILING TO WALL, LEVEL, y PASS-THROUGH; para el montaje flexible del sistema; diferentes drivers para todo el sistema MOVE IT

### Types

- 1 Linear Connector
- 2 L-Connector
- 3 T-Connector
- 4 X-Connector
- 5 Flex Connector
- 6 Ceiling to Wall Connector
- 7 Level Connector
- 8 Pass Through Connector

### Configurations

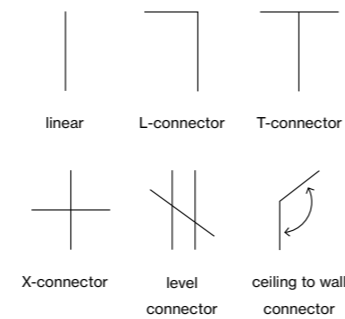

### Colours



### Order options

CONNECTOR MECHANICAL	T
recessed*	1
surface	2
suspended square	3
suspended round	4

\*T- and X-connector on request

### CONTROL

DALI-2	
--------	--

### MATERIAL COLOUR

○ traffic white* RAL 9016	7
● jet black RAL 9005	8

\*not for mechanical recessed trimless

### Options on request

#### CONNECTOR

T connector electrical	
T connector mechanical	
X connector electrical	
X connector mechanical	

only for recessed trimless

### Electrical accessories

#### LINEAR CONNECTOR

TYPE	ORDER CODE
linear connector electrical	030-210113
linear connector mechanical	030-1T3401

#### L CONNECTOR

TYPE	ORDER CODE
L connector electrical	030-211113
L connector mechanical	030-1T3501

#### T CONNECTOR

TYPE	ORDER CODE
T connector electrical	030-212113
T connector mechanical	030-1T3601

#### X CONNECTOR

TYPE	ORDER CODE
X connector electrical	030-213113
X connector mechanical	030-1T3701

#### FLEX CONNECTOR

TYPE	ORDER CODE
flex connector electrical	030-214113

#### CEILING TO WALL CONNECTOR

TYPE	ORDER CODE
ceiling to wall connector electrical	030-216113

#### LEVEL CONNECTOR

TYPE	ORDER CODE
level connector electrical	030-215113

#### PASS THROUGH CONNECTOR

TYPE	ORDER CODE
pass through connector electrical (pair)	030-217113

electrical connection from direct to indirect and vice versa

#### POWER FEEDER

TYPE	ORDER CODE
power feeder (only for surface)	030-252303
internal power feeder (incl. cable 2000mm)	030-252503

#### POWER SUPPLY EXTERNAL supply 220-240V AC, 48V, 50-60Hz

TYPE	EFFICIENCY	MOUNTING	L-W-H (mm)	ORDER CODE
60W □ PC II η88%	external	163-43-32	002-62133	
150W □ PC II η92%	external	350-30-18	002-62135	
250W □ PC II η93%	external	400-40-22	002-62139	

ENEC approved, incl. feeder cable 2000mm

#### POWER SUPPLY BASIC 48V

220-240V | 50-60Hz | □ PC II | Lifetime @ 120W, 45° ambient temp. cascable max. 3 devices

TYPE	EFFICIENCY/LIFETIME	W-H-D (mm)	ORDER CODE
160W η94.5% / > 100.000h	72-90-63	005-6520210	

#### DIN RAIL POWER SUPPLY PRO 48V

220-240V | 50-60Hz | ☉ PC I | MTBF @ 55° ambient temperature cascable max. 5 devices (240W) or 3 devices (480W)

TYPE	EFFICIENCY/MTBF	W-H-D (mm)	ORDER CODE
240W η92% / > 400.000h	60-125-100	005-6220110	
480W η93% / > 350.000h	120-125-100	005-6220210	

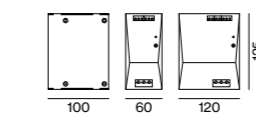
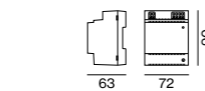
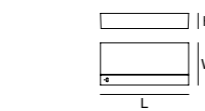
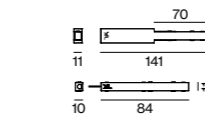
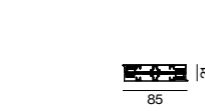
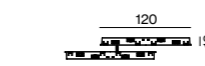
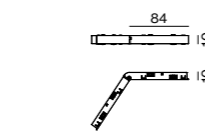
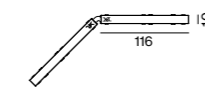
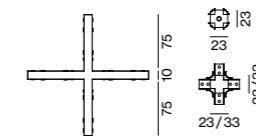
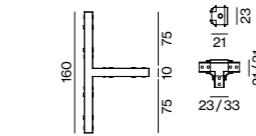
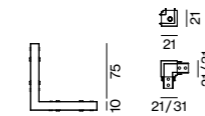
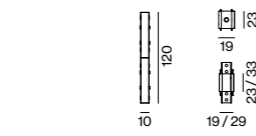

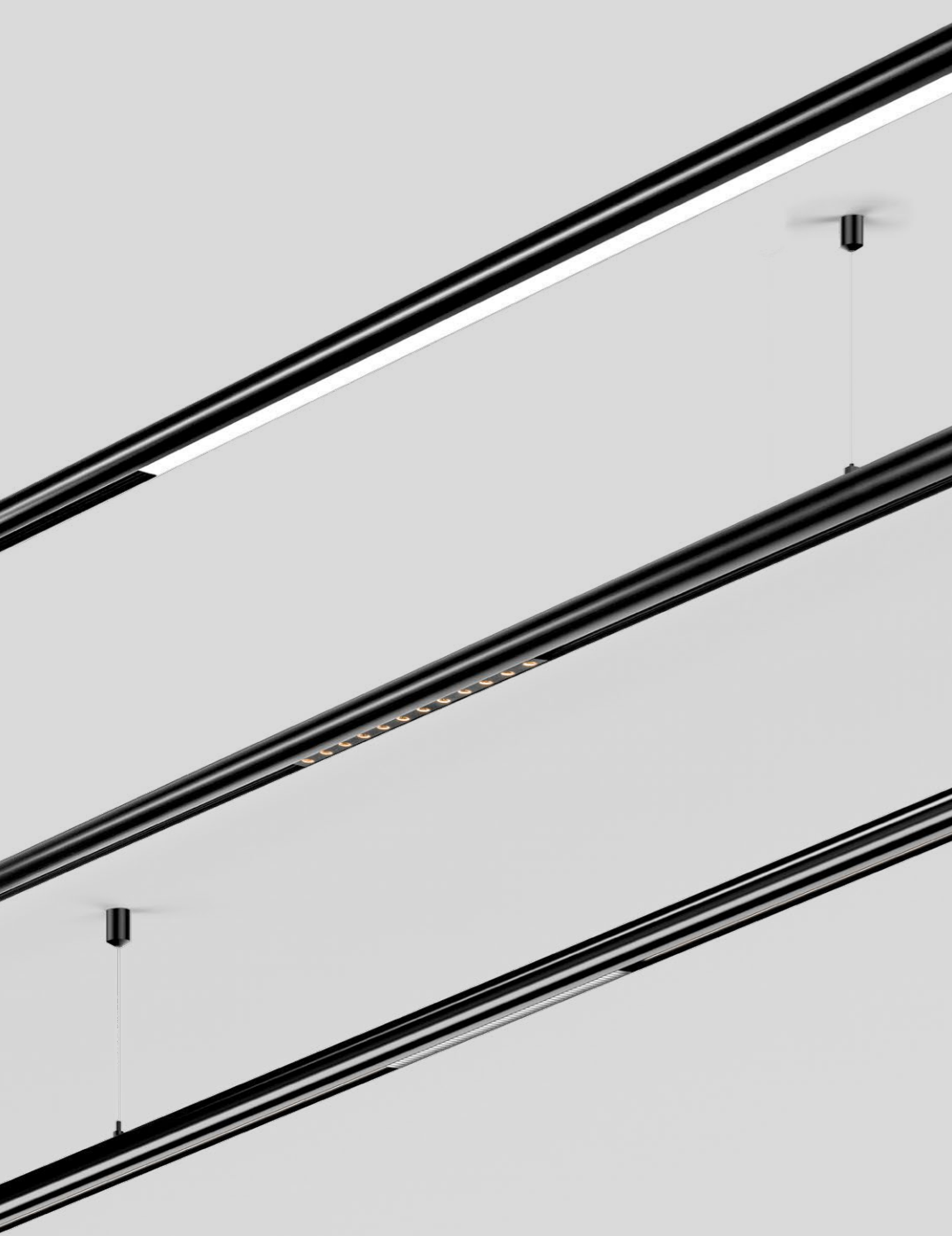

**Quickinfo**

2700 K, 3000 K, 4000 K  
 CRI ≥ 90  
 up to 105 lm/W  
 DALI-2

**Types**

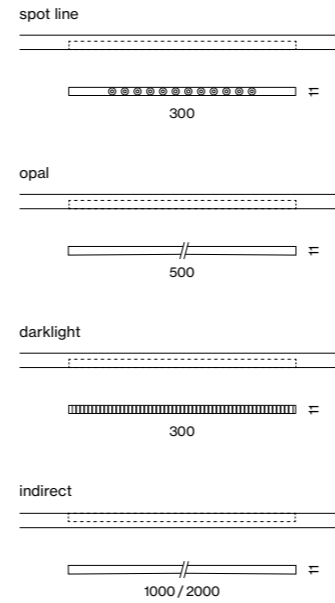

**Colour**



**Light distributions**

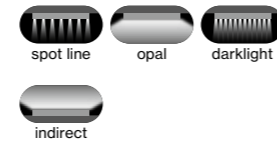

**Order options**

COLOUR TEMPERATURE	
2700K	4
3000K	5
4000K	6

**CONTROL**  
 DALI-2

**MATERIAL COLOUR**  
 ● jet black RAL 9005

LIGHT OPTIC	
spot line	
opal high performance	
darklight	
indirect	

**LIGHT INSET 10**

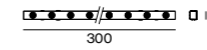
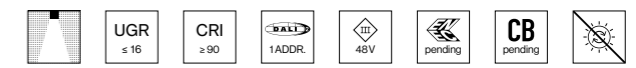

INS. POWER	COLOUR TEMP.	LUM. FLUX	L (mm)	ORDER CODE
8.5 W	2700 K	420 lm	300	0 3 0 - 6 1 1 0 :: 3 8 M
	3000 K	460 lm		
	4000 K	480 lm		

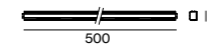

INS. POWER	COLOUR TEMP.	LUM. FLUX	L (mm)	ORDER CODE
5 W	2700 K	520 lm	500	0 3 0 - 6 1 2 0 :: 3 8 H
	3000 K	520 lm		
	4000 K	525 lm		

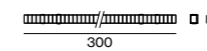

INS. POWER	COLOUR TEMP.	LUM. FLUX	L (mm)	ORDER CODE
5.7 W	2700 K	280 lm	300	0 3 0 - 6 2 1 0 :: 3 8 M
	3000 K	280 lm		
	4000 K	285 lm		

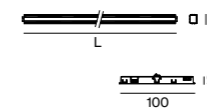
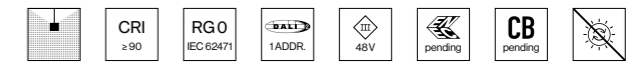

INDIRECT incl. feeder				
INS. POWER	COLOUR TEMP.	LUM. FLUX	L (mm)	ORDER CODE
15 W	2700 K	1370 lm	1000	0 3 0 - 6 3 3 0 :: 3 8 M
	3000 K	1450 lm		
	4000 K	1530 lm		
30 W	2700 K	2750 lm	2000	0 3 0 - 6 3 7 0 :: 3 8 M
	3000 K	2900 lm		
	4000 K	3050 lm		

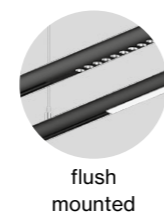

flush mounted

**INSET POWER** is the current consumption excluding any ballast  
**LUMINOUS FLUX** value calculated for CRI ≥ 90, colour black



**SPOT LINE / OPAL / DARKLIGHT**

linear inset 10

**Private Residence**  
Visualisation





**TILA**  
decorative inset 10

**Quickinfo**

2700 K, 3000 K, 4000 K  
CRI ≥ 90  
up to 81 lm/W  
DALI-2

**Types**

adjustable rod

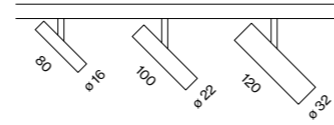

suspended

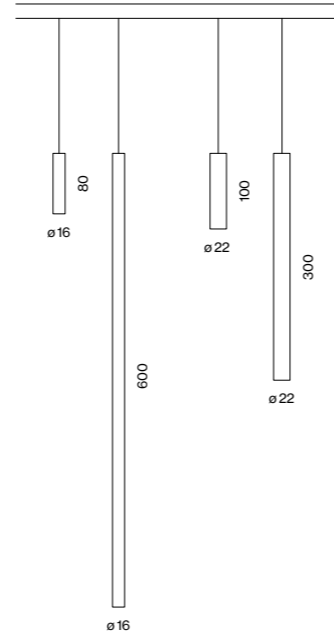

**Colours**



**Light distributions**

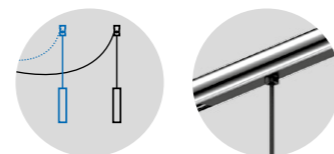
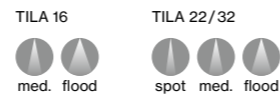

free positioning by cable and hook

flush adapter mounting

**Order options**

HOUSING HEIGHT TILA 16	
80 mm	0
600 mm	1

HOUSING HEIGHT TILA 22	
100 mm	3
300 mm	4

COLOUR TEMPERATURE	
2700 K	4
3000 K	5
4000 K	6

CONTROL	
DALI-2	

MATERIAL COLOUR	
○ traffic white RAL 9016	7
● jet black RAL 9005	8
● brushed aluminium	6
● chrome	4

MATERIAL COLOUR ACCESSORIES	
○ traffic white RAL 9016	7
● jet black RAL 9005	8

BEAM ANGLE TILA 16	
medium 20°	M
flood 40°	F

BEAM ANGLE TILA 22/32	
spot 14°	S
medium 24°	M
flood 45°	F

**Options on request**

MATERIAL COLOUR	
● gun metal	
● brushed brass	
● rose gold	

**INSET POWER** is the current consumption excluding any ballast  
**LUMINOUS FLUX** value calculated for CRI ≥ 90, colour white, medium

**TILA 16**

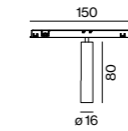

**ADJUSTABLE**

INSET POWER	COLOUR TEMP.	LUMINOUS FLUX	ORDER CODE
5 W	2700 K	230 lm	030-6500::3▲
	3000 K	240 lm	
	4000 K	250 lm	

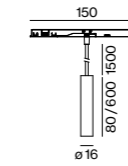

**SUSPENDED**

INSET POWER	COLOUR TEMP.	LUMINOUS FLUX	ORDER CODE
5 W	2700 K	230 lm	030-66L0::3▲
	3000 K	240 lm	
	4000 K	250 lm	

**TILA 22**

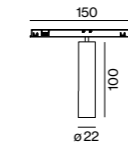

**ADJUSTABLE**

INSET POWER	COLOUR TEMP.	LUMINOUS FLUX	ORDER CODE
10.5 W	2700 K	415 lm	030-6530::3▲
	3000 K	440 lm	
	4000 K	460 lm	

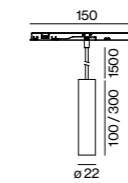

**SUSPENDED**

INSET POWER	COLOUR TEMP.	LUMINOUS FLUX	ORDER CODE
10.5 W	2700 K	415 lm	030-66L0::3▲
	3000 K	440 lm	
	4000 K	460 lm	

**TILA 32**

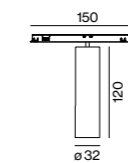

**ADJUSTABLE**

INSET POWER	COLOUR TEMP.	LUMINOUS FLUX	ORDER CODE
11 W	2700 K	720 lm	030-6560::3▲
	3000 K	850 lm	
	4000 K	900 lm	

**Mounting accessories**

HOOK ceiling mounted			
TYPE	Ø-H (mm)		ORDER CODE
hook	16-30		030-100001■

**Optical accessories**

HONEYCOMB LOUVER		
TYPE	Ø-H (mm)	ORDER CODE
TILA 22	20-3	007-1965118
TILA 32	30-3	007-1965168

**Jewellery Shop**  
Visualisation



**Private Residence**  
Visualisation



**Private Residence**  
Visualisation





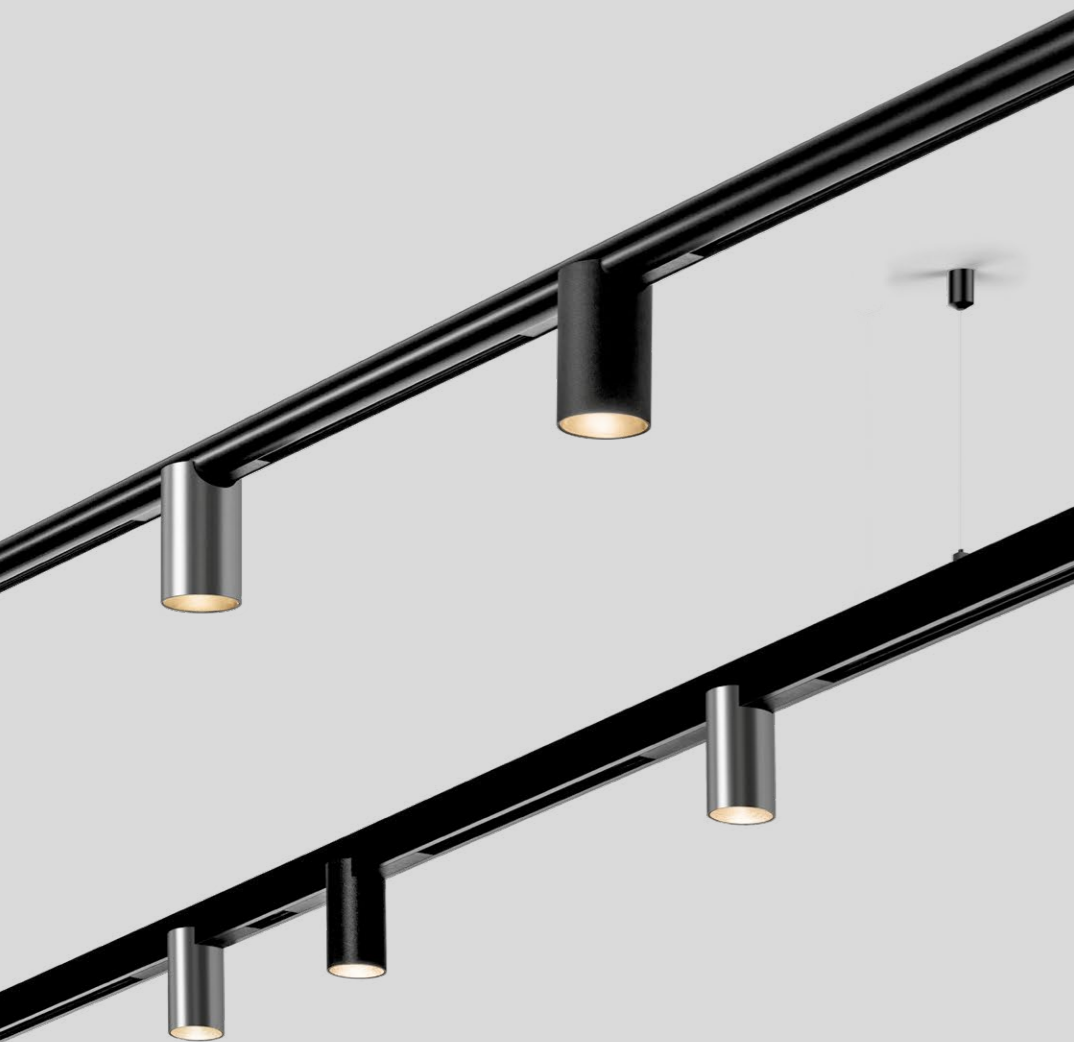

**TARO**  
decorative inset 10

**Quickinfo**

2700 K, 3000 K, 4000 K  
CRI ≥ 90  
up to 83lm/W  
DALI-2

**Types**

square track

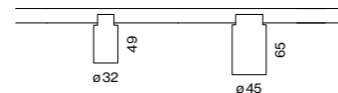

round track

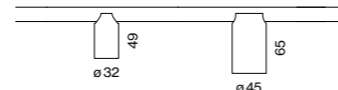

**Colours**



**Light distributions**

TARO 32



TARO 45



wallwasher floor  
360° rotatable



wallwasher floor

**Order options**

COLOUR TEMPERATURE	
2700 K	4
3000 K	5
4000 K	6

CONTROL	
DALI-2	

MATERIAL COLOUR	
○ traffic white RAL 9016	7
● jet black RAL 9005	8
● brushed aluminium	6
● chrome	4

BEAM ANGLE TARO 32	
spot 18°	S
medium 23°	M
flood 37°	F

BEAM ANGLE TARO 45	
medium 24°	M
flood 39°	F

**Options on request**

MATERIAL COLOUR	
● gun metal	
● brushed brass	
● rose gold	

**TARO 32**

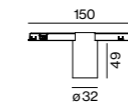

**DOWNLIGHT SQUARE TRACK**

INSET POWER	COLOUR TEMP.	LUMINOUS FLUX	ORDER CODE
11 W	2700 K	720 lm	030-6700::3▲
	3000 K	860 lm	
	4000 K	900 lm	

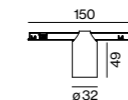

**DOWNLIGHT ROUND TRACK**

INSET POWER	COLOUR TEMP.	LUMINOUS FLUX	ORDER CODE
11 W	2700 K	720 lm	030-6740::3▲
	3000 K	860 lm	
	4000 K	900 lm	

**TARO 45**

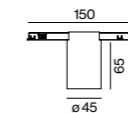

**DOWNLIGHT SQUARE TRACK**

INSET POWER	COLOUR TEMP.	LUMINOUS FLUX	ORDER CODE
15 W	2700 K	1000 lm	030-6710::3▲
	3000 K	1100 lm	
	4000 K	1150 lm	

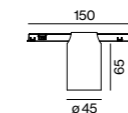

**DOWNLIGHT ROUND TRACK**

INSET POWER	COLOUR TEMP.	LUMINOUS FLUX	ORDER CODE
15 W	2700 K	1000 lm	030-6750::3▲
	3000 K	1100 lm	
	4000 K	1150 lm	

**TARO 45 wallwasher floor**

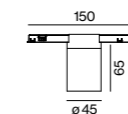

**DOWNLIGHT SQUARE TRACK**

INSET POWER	COLOUR TEMP.	LUMINOUS FLUX	ORDER CODE
9 W	2700 K	530 lm	030-6780::3▲W
	3000 K	570 lm	
	4000 K	580 lm	

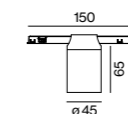

**DOWNLIGHT ROUND TRACK**

INSET POWER	COLOUR TEMP.	LUMINOUS FLUX	ORDER CODE
9 W	2700 K	530 lm	030-6790::3▲W
	3000 K	570 lm	
	4000 K	580 lm	

**Optical accessories**

**HONEYCOMB LOUVER**

TYPE	Ø-H (mm)	ORDER CODE
TARO 32	30.4	007-1965168
TARO 45	42.3	007-1965188

**INSET POWER** is the current consumption excluding any ballast  
**LUMINOUS FLUX** value calculated for CRI ≥ 90, colour white, medium

**Jewellery Shop**  
Visualisation



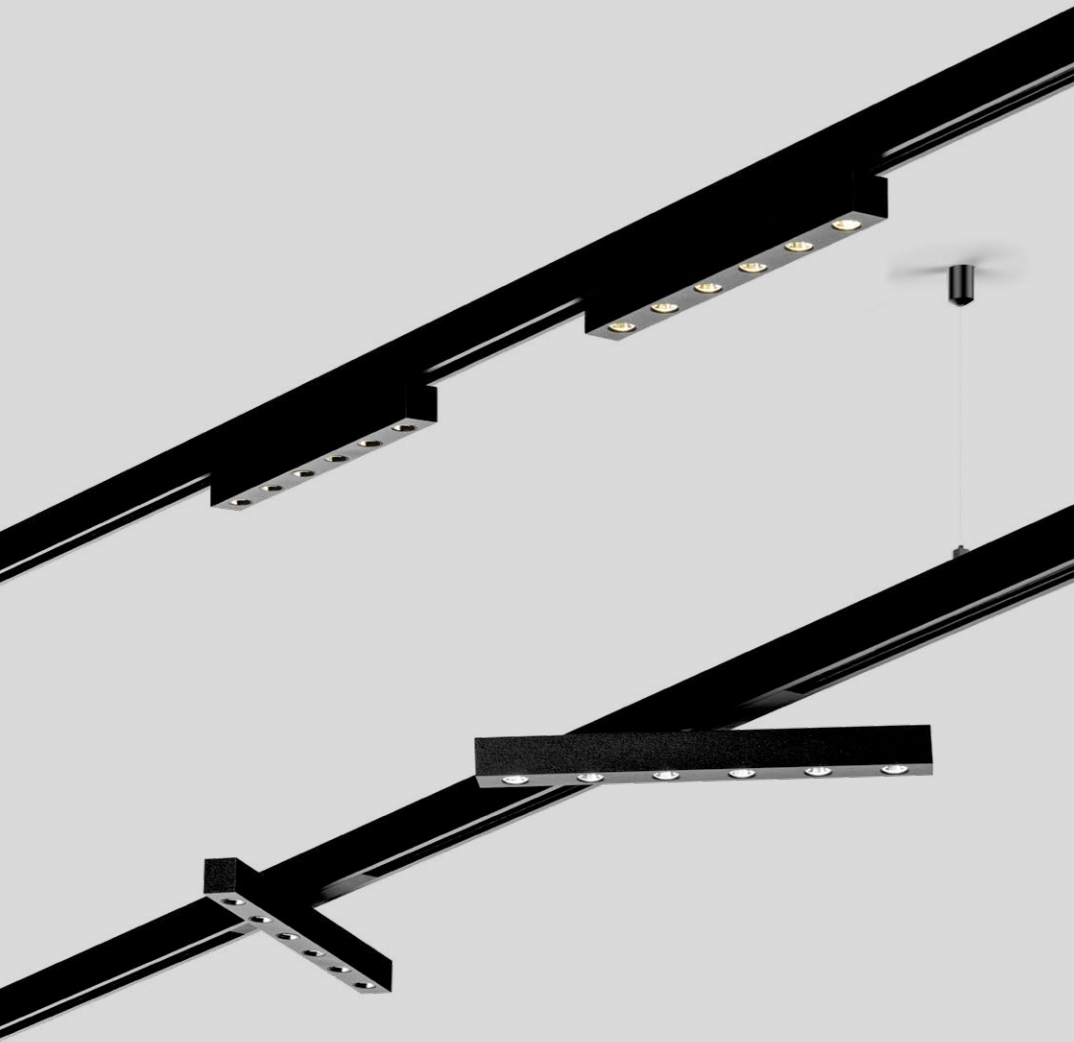

**Quickinfo**

2700 K, 3000 K, 4000 K  
 CRI ≥ 90  
 up to 79 lm/W  
 DALI-2

**Type**



**Colours**



**Light distributions**



**Order options**

COLOUR TEMPERATURE	
2700K	4
3000K	5
4000K	6

**CONTROL**

DALI-2

**MATERIAL COLOUR**

<input type="radio"/> traffic white RAL 9016	7
<input checked="" type="radio"/> jet black RAL 9005	8

**BEAM ANGLE**

medium 20°	M
flood 40°	F

**GIRA**

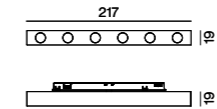

**DOWNLIGHT ROTATABLE**

INSET POWER	COLOUR TEMP.	LUMINOUS FLUX	ORDER CODE
19 W	2700 K	1350 lm	0 3 0 - 6 4 1 0 :: 3 ▣ ▲
	3000 K	1400 lm	
	4000 K	1450 lm	

**GIRA wallwasher floor**

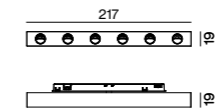

**WALLWASHER FLOOR ROTATABLE**

INSET POWER	COLOUR TEMP.	LUMINOUS FLUX	ORDER CODE
11 W	2700 K	730 lm	0 3 0 - 6 4 3 0 :: 3 ▣ W
	3000 K	770 lm	
	4000 K	800 lm	



**GIRA**  
 decorative inset 10

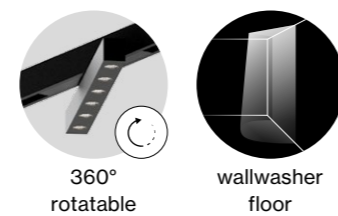

**INSET POWER** is the current consumption excluding any ballast  
**LUMINOUS FLUX** value calculated for CRI ≥ 90, colour white, medium

**Private Residence**  
Visualisation





**Quickinfo**

2700 K, 3000 K, 4000 K  
 CRI ≥ 90  
 up to 110 lm/W  
 DALI-2

**Types**

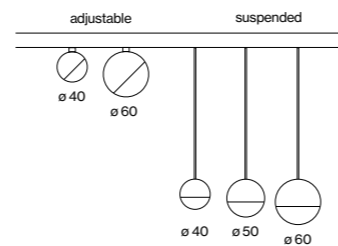

**Colours**



**Light distribution**



direct



365° rotatable  
 90° tiltable

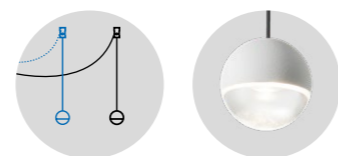

free positioning by  
 cable and hook

high quality  
 glass lens

**Order options**

COLOUR TEMPERATURE	
2700 K	4
3000 K	5
4000 K	6

CONTROL	
DALI-2	

MATERIAL COLOUR	
○ traffic white RAL 9016	7
● jet black RAL 9005	8
● brushed aluminium	6
● chrome	4

MATERIAL COLOUR ACCESSORIES	
○ traffic white RAL 9016	7
● jet black RAL 9005	8

BEAM ANGLE	
direct 80°	

**Options on request**

MATERIAL COLOUR	
● gun metal	
● brushed brass	
● rose gold	

**NOBA 40**

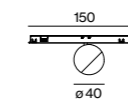

**SPOTLIGHT ADJUSTABLE**

INSET POWER	COLOUR TEMP.	LUMINOUS FLUX	ORDER CODE
4.5 W	2700 K	465 lm	030-6800::3
	3000 K	480 lm	
	4000 K	500 lm	

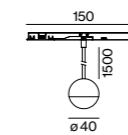

**DOWNLIGHT SUSPENDED**

INSET POWER	COLOUR TEMP.	LUMINOUS FLUX	ORDER CODE
4.5 W	2700 K	465 lm	030-6900::3
	3000 K	480 lm	
	4000 K	500 lm	

**NOBA 50**

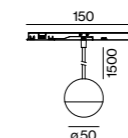

**DOWNLIGHT SUSPENDED**

INSET POWER	COLOUR TEMP.	LUMINOUS FLUX	ORDER CODE
9 W	2700 K	695 lm	030-6910::3
	3000 K	725 lm	
	4000 K	760 lm	

**NOBA 60**

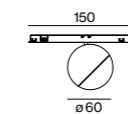

**SPOTLIGHT ADJUSTABLE**

INSET POWER	COLOUR TEMP.	LUMINOUS FLUX	ORDER CODE
10 W	2700 K	715 lm	030-6820::3
	3000 K	745 lm	
	4000 K	780 lm	

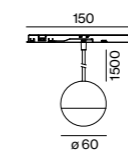

**DOWNLIGHT SUSPENDED**

INSET POWER	COLOUR TEMP.	LUMINOUS FLUX	ORDER CODE
10 W	2700 K	715 lm	030-6920::3
	3000 K	745 lm	
	4000 K	780 lm	

**Mounting accessories**



HOOK ceiling mounted

TYPE	Ø-H (mm)	ORDER CODE
hook	16-30	030-100001



**NOBA**  
 decorative inset 10

**INSET POWER** is the current consumption excluding any ballast  
**LUMINOUS FLUX** value calculated for CRI ≥ 90, colour white

**Private Residence**  
Visualisation

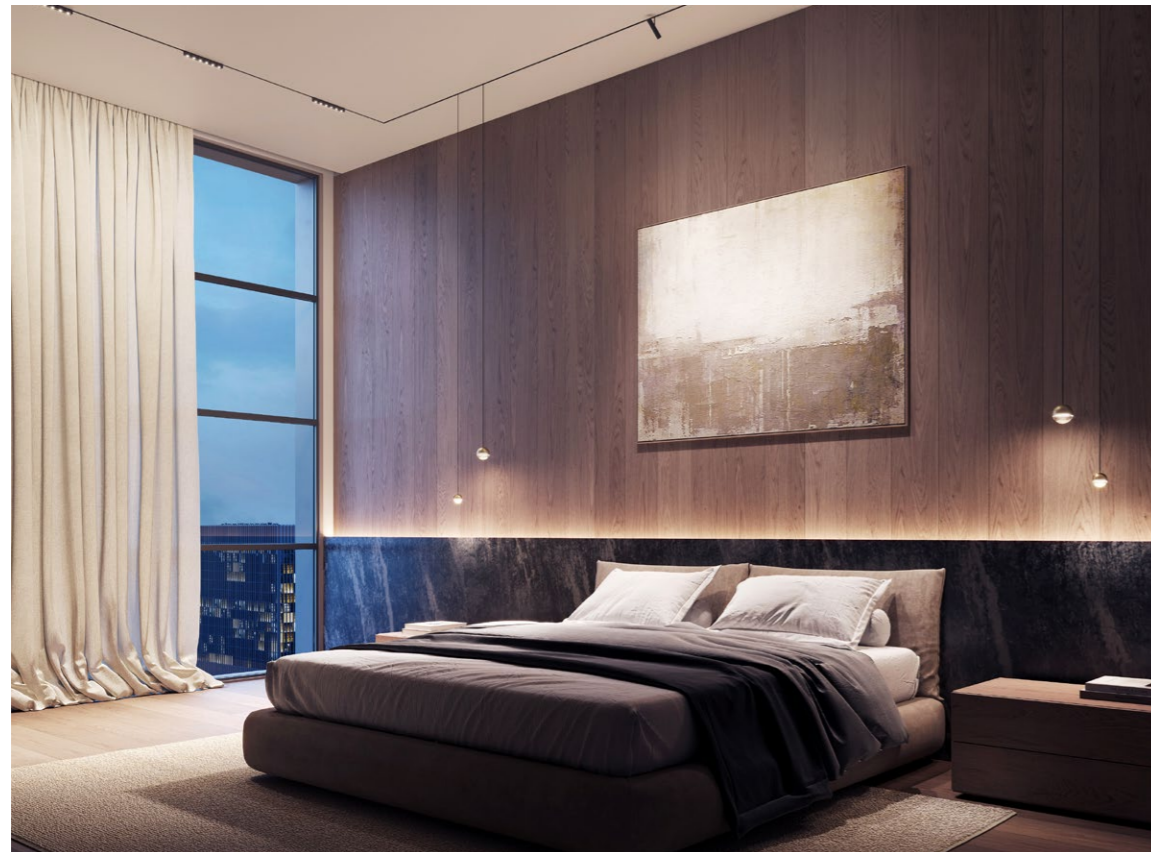

# Perfect allrounder

## TUBO/SETA 60 CONEX system

**EN** TUBO and SETA make a name for themselves as uniform and minimalist lighting system luminaires that can be flexibly joined by various connecting elements. The luminaires are available for wall and ceiling mounting, as well as in suspended pendant versions. Thanks to their opal cover, the TUBO system luminaire delivers uniform ambient illumination and the characteristic beam angle of up to 340° ensures a soft ceiling illumination that helps build a pleasant room atmosphere. SETA system luminaire's reflectors are particularly noteworthy and have been optimised for office spaces and designed for working at screens. The indirect light component creates a pleasant, homogeneous ceiling illumination for every work area. The CONEX connector (patent pending) grants the system a high degree of flexibility. As a mechanical and electrical L-, T-, and X-shaped connecting element, it allows implementation of geometric shapes over several levels.

**ES** Las luminarias modulares TUBO y SETA son sistemas de iluminación homogéneos y minimalistas que pueden unirse unos a otros de un modo flexible utilizando diferentes elementos de unión. Estas luminarias también están disponibles para el montaje en pared o techo y como variantes de suspensión. El difusor opal de TUBO permite a esta luminaria ofrecer un alumbrado general homogéneo, y su ángulo de proyección característico de hasta 340° garantiza una suave iluminación del techo que crea una atmósfera espacial positiva. Cabe destacar especialmente los reflectores optimizados para oficinas de la luminaria modular SETA, que han sido diseñados especialmente para el trabajo con pantallas de visualización. La proporción de luz indirecta genera una iluminación del techo homogénea y agradable en cualquier zona de trabajo. El conector CONEX (en espera de patente) dota al sistema de una gran flexibilidad. El elemento de unión mecánica y eléctrica en forma de L, T o X permite obtener formas geométricas en varios niveles.

### Type



60

### Mountings

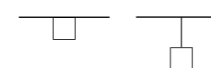

surface

suspended

### System configurations



linear

L

T

X

### Light distributions

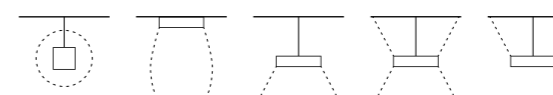

opal

reflector  
(UGR ≤ 19)

direct

direct  
indirect

indirect

## Connector CONEX

**EN** The patent pending CONEX connector system for the TUBO 60 system now offers even more design freedom. With the flexible lighting system, geometric shapes or exciting light sculptures can be created. Thanks to the mechanical and electrical connectors in L, T and X shapes, a visually uniform lighting system is created. In combination with the SETA system, various areas of application are possible - whether as corridor, office luminaire or visual guidance system.

**ES** El sistema de unión CONEX (en espera de patente) para la luminaria modular TUBO 60 ofrece aún más libertad de configuración. Este sistema de conexión flexible permite crear formas geométricas o esculturas de luz magníficas. Gracias a los elementos de unión mecánica y eléctrica en forma de L, T o X es posible obtener un sistema de iluminación visualmente homogéneo. Combinado con la luminaria modular SETA, su uso es posible en distintas aplicaciones, tales como luminarias de pasillos u oficinas o como sistema de direccionamiento visual.

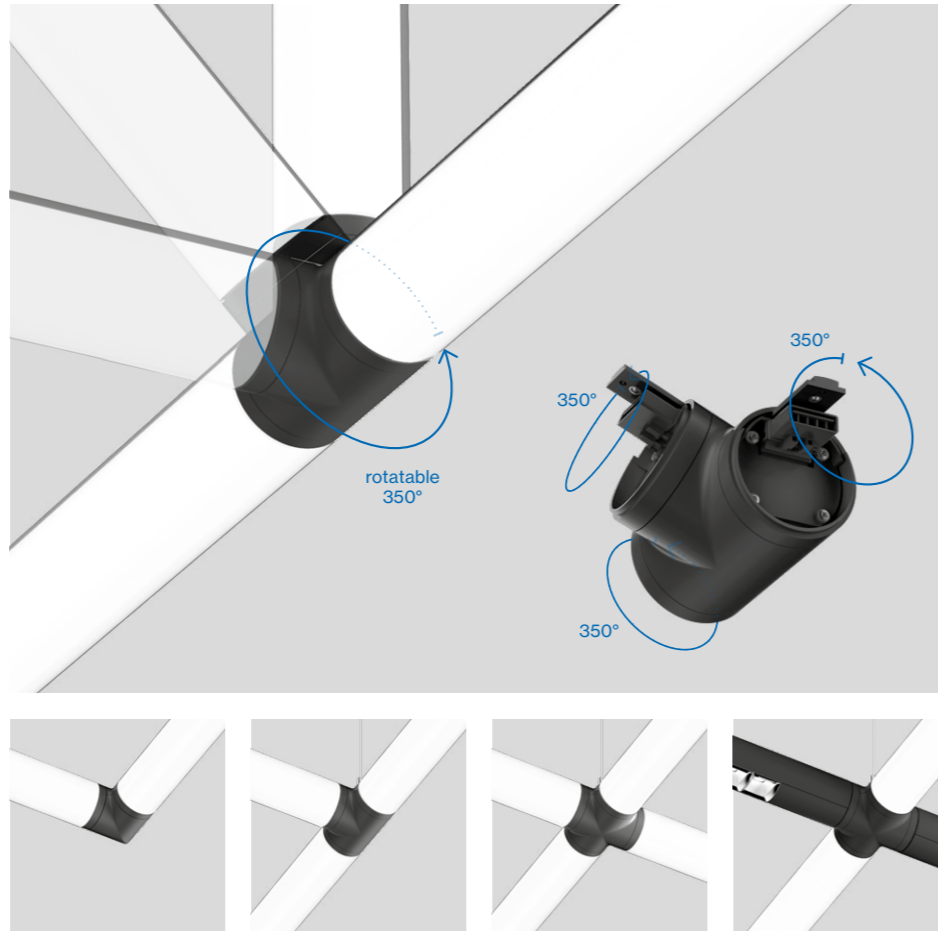

## Easy mounting

**EN** CONEX system luminaires are electrically and mechanically connected by a simple plug-in connection. This makes the installation of a complex lighting system simple, quick, and straightforward.

**ES** Las luminarias modulares CONEX se conectan eléctrica y mecánicamente con una simple conexión enchufable. Con ello, el montaje de un sistema de iluminación completo puede realizarse de un modo muy sencillo, rápido y sin complicaciones.

## 340° light distribution

**EN** With its 340° beam pattern and opal cover, TUBO System delivers homogeneous illumination as well as slight ceiling brightening. This makes the system luminaire perfect for places where pleasant ambient lighting is desired, such as reception areas, corridors, or foyers.

**ES** Con su ángulo de proyección de 340° y su difusor opal, TUBO System ofrece un alumbrado homogéneo unido a una iluminación leve del techo. Por eso, esta luminaria modular es perfecta para lugares en los que se desea contar con una iluminación general agradable, como zonas de recepción, pasillos o vestíbulos.

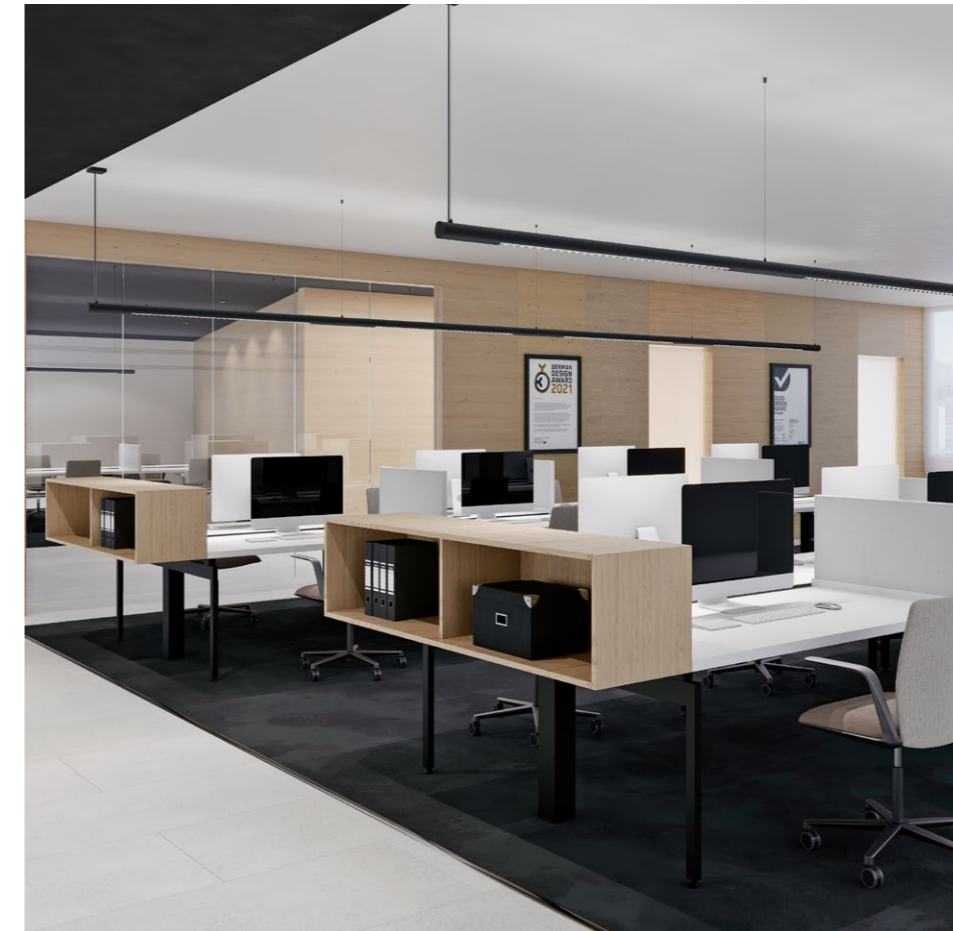
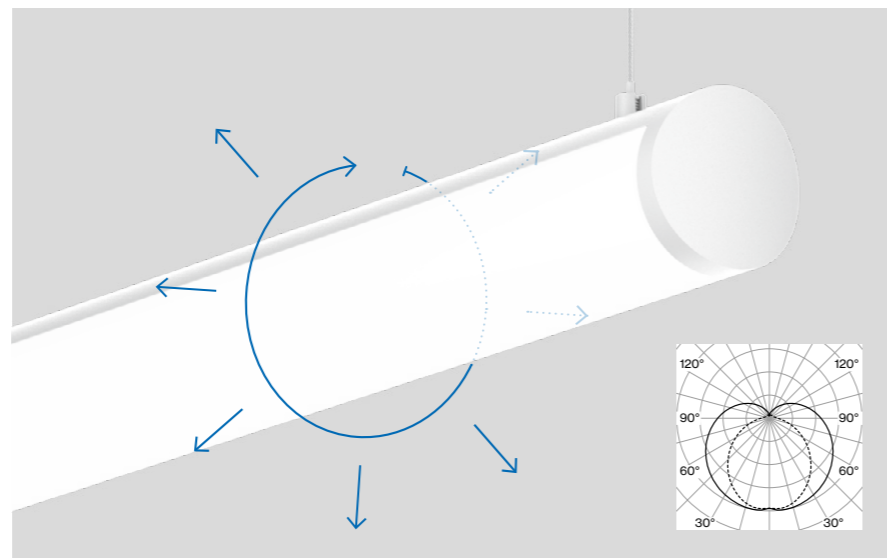

## Work-friendly light

**EN** As an office luminaire, SETA guarantees illumination that is compliant with workplace standards (up to  $UGR \leq 16$ ). Custom glare-free reflectors and the selected use of blind covers direct the light precisely to the work surface and reduce reflections. The direct/indirect version comes with special lens technology that distributes the indirect light component homogeneously and broadly towards the ceiling.

**ES** Como luminaria de oficina, SETA ofrece una iluminación de puestos de trabajo adaptada a la normativa (hasta  $UGR \leq 16$ ). Unos reflectores especiales libres de deslumbramiento y el empleo selectivo de difusores opacos dirigen la luz con precisión a la superficie de trabajo y reducen los reflejos. En la variante directa/indirecta, la tecnología de lentes especial distribuye de manera homogénea en el techo una proporción de luz indirecta con un ángulo de apertura muy amplio.

## Advanced sensor technology

**EN** Special sensors expand the product family SETA with smart lighting control and collection of insightful data. The ESSENTIAL sensor enables dynamic adjustment of the lighting to ambient brightness and room activity. The SENSE version also measures values such as temperature, air quality, humidity and noise level. These data not only provide important insights into the ambient conditions and use of rooms, but also support energy savings in the long term.

**ES** Unos sensores especiales amplían la familia de productos SETA con el control inteligente de la iluminación. El sensor ESSENTIAL permite adaptar la luz dinámicamente a la luminosidad del entorno y a la actividad de la sala. La variante SENSE también mide valores como la temperatura, la calidad y humedad del aire y el nivel de ruido. Estos datos no solo ofrecen información importante sobre las condiciones ambientales y el uso de las salas, sino también fomentan el ahorro energético de un modo duradero.

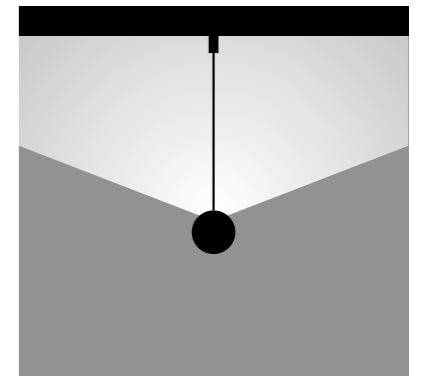

## Indirect version

**EN** SETA indirect stands for the minimalist design of the product family and expands it with an indirect luminaire that provides homogeneous ceiling lighting. This creates a pleasant room feeling and the possibility to illuminate ceiling patterns harmoniously.

**ES** La luminaria SETA indirect representa el diseño minimalista de esta familia de productos y la amplía con una luminaria de luz indirecta que proporciona una iluminación homogénea del techo. Esto genera una sensación agradable en la sala y ofrece la posibilidad de iluminar patrones de techo armoniosamente.



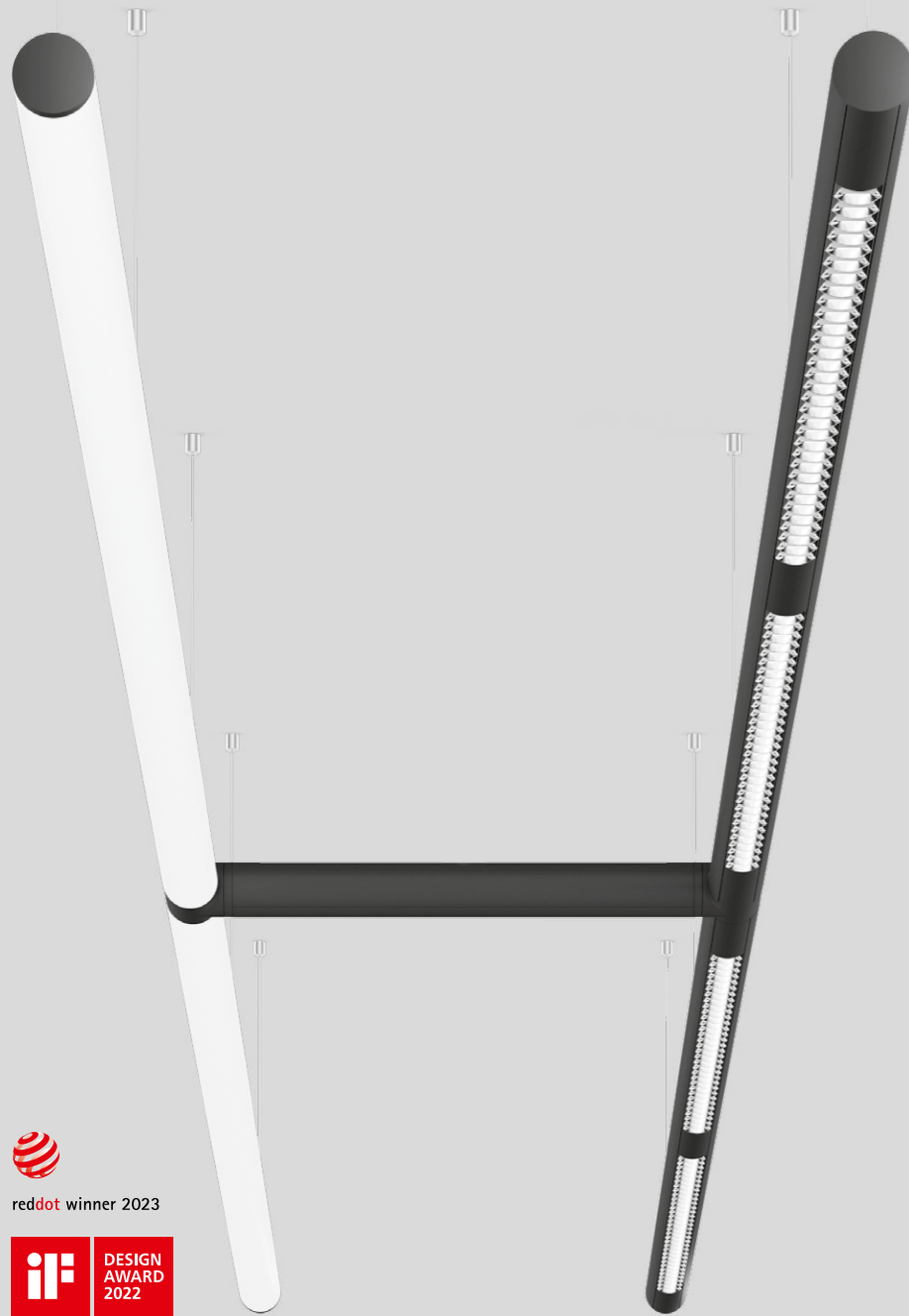

reddot winner 2023



## TUBO/SETA 60 CONEX system

surface/suspended

EN Cylindrical lighting system in aluminium; powder coated; ceiling surface mounting or suspended mounting; height adjustment without tools; with transparent feeder cable; electrical connection of the luminaires via plug/socket system; optionally connectors (L-, T- or X-shape); luminaire connection rotatable around its own axis, which means that any spatial angle can be realized; optionally cylindrical HPO (High Performance Opal) cover or high gloss reflector with faceted design; light control via high quality lens system for homogeneous illumination (HPO); direct, indirect or direct / indirect light distribution (reflector); indirect light component with integrated PC boards and high quality lens system for homog. ceiling illumination, separately controllable; energy-eff. LEDs - very good colour rendering

ES Sistema de iluminación cilíndrico de aluminio; recubierto de polvo; montaje sobre techo o suspendido; altura regulable sin herramientas; incl. cable de alimentación transparente; unión eléctrica de las luminarias con conexión macho/hembra; conector opcional (en forma de L, T o X); conexión de luminaria girable en su propio eje que permite la orientación en cualquier ángulo de la sala; disponible con difusor cilíndr. HPO (High Performance Opal) o reflector de alto brillo con óptica facetada; direccionamiento de la luz con óptica de lente de alta calidad para un alumbrado homogéneo (HPO); proyección directa, indirecta o directa/indirecta (reflector); componente de luz indir. con plet. propias y ópt. de lente de alta calidad para un alumb. de techo y homog. con control indep.; LED energét. efíc. - excelente reprodr. crom.

### Quickinfo

3000K, 4000K  
CRI ≥ 80, 3 SDCM  
UGR ≤ 19 / 65° ≤ 3000 cd/m<sup>2</sup>  
opal up to 3230 lm/m  
up to 160 lm/W  
L90 @ 50 000h  
DALI-2  
opal, reflector (UGR ≤ 19)

### Types

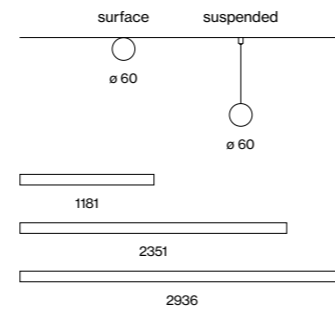

CONEX connector

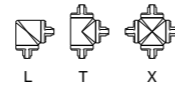

### Colours

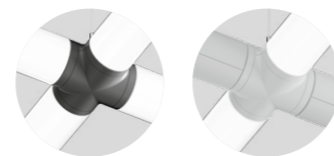
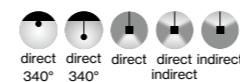
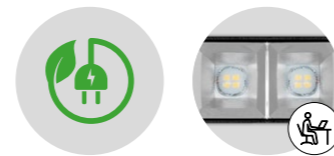
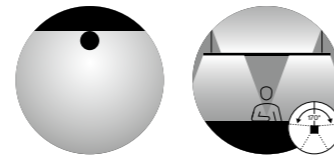

### Light distributions

connector  
CONEXcombinable with  
TUBO & SETAup to 160 lm/W  
(high efficiency)DIN EN 12464-1  
UGR ≤ 19TUBO: direct  
340° uniform  
illuminationSETA: direct  
and 170° indirect  
illumination

### Order options

#### THROUGH WIRE TYPE

standard	2
CONEX L/T/X	3

between two CONEX connectors  
one CONEX luminaire or blind channel  
is needed

#### COLOUR TEMPERATURE

3000K	5
4000K	6

#### CONTROL

DALI-2

#### MATERIAL COLOUR

○ pure white RAL 9010	7
● jet black RAL 9005	8

#### REFLECTOR COLOUR

▨ chrome	R
● dark chrome	B

### TUBO 60 surface/suspended

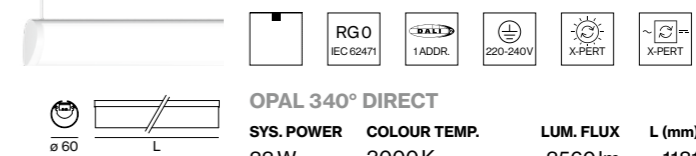

#### OPAL 340° DIRECT

SYS. POWER	COLOUR TEMP.	LUM. FLUX	L (mm)	ORDER CODE
33 W	3000K	3560lm	1181	058-30043
	4000K	3760lm		
66 W	3000K	7110lm	2351	058-30083
	4000K	7530lm		
82 W	3000K	8890lm	2936	058-30093
	4000K	9410lm		



### SETA 60 surface/suspended

#### REFLECTOR DIRECT

SYS. POWER	COLOUR TEMP.	LUM. FLUX	L (mm)	ORDER CODE
19.3 W	3000K	2670lm	1181	058-40043
	4000K	3040lm		
45 W	3000K	6240lm	2351	058-40083
	4000K	7100lm		
58 W	3000K	8020lm	2936	058-40093
	4000K	9130lm		

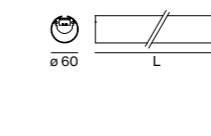

#### REFLECTOR DIRECT/INDIRECT

SYS. POWER	COLOUR TEMP.	LUM. FLUX	L (mm)	ORDER CODE
45 W	3000K	↓ 2670/± 3530lm	1181	058-41043
(2×DALI)	4000K	↓ 3040/± 4010lm		
92 W	3000K	↓ 6240/± 7050lm	2351	058-41083
(2×DALI)	4000K	↓ 7100/± 8030lm		
116 W	3000K	↓ 8020/± 8820lm	2936	058-41093
(2×DALI)	4000K	↓ 9130/± 10000lm		

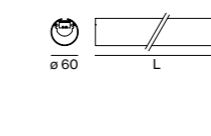

#### INDIRECT

SYS. POWER	COLOUR TEMP.	LUM. FLUX	L (mm)	ORDER CODE
26.1 W	3000K	3530lm	1181	058-42043
	4000K	4010lm		
52 W	3000K	7050lm	2351	058-42083
	4000K	8030lm		
65 W	3000K	8820lm	2936	058-42093
	4000K	10000lm		

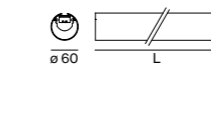

#### BLIND CHANNEL incl. through wiring

L (mm)	ORDER CODE
585	058-490203
1185	058-490403
2351	058-490803
2936	058-490903

### Accessories

see next page

LUMINOUS FLUX value calculated for  
CRI ≥ 80, colour white, cover opal  
or reflector chrome

**Configuration example**

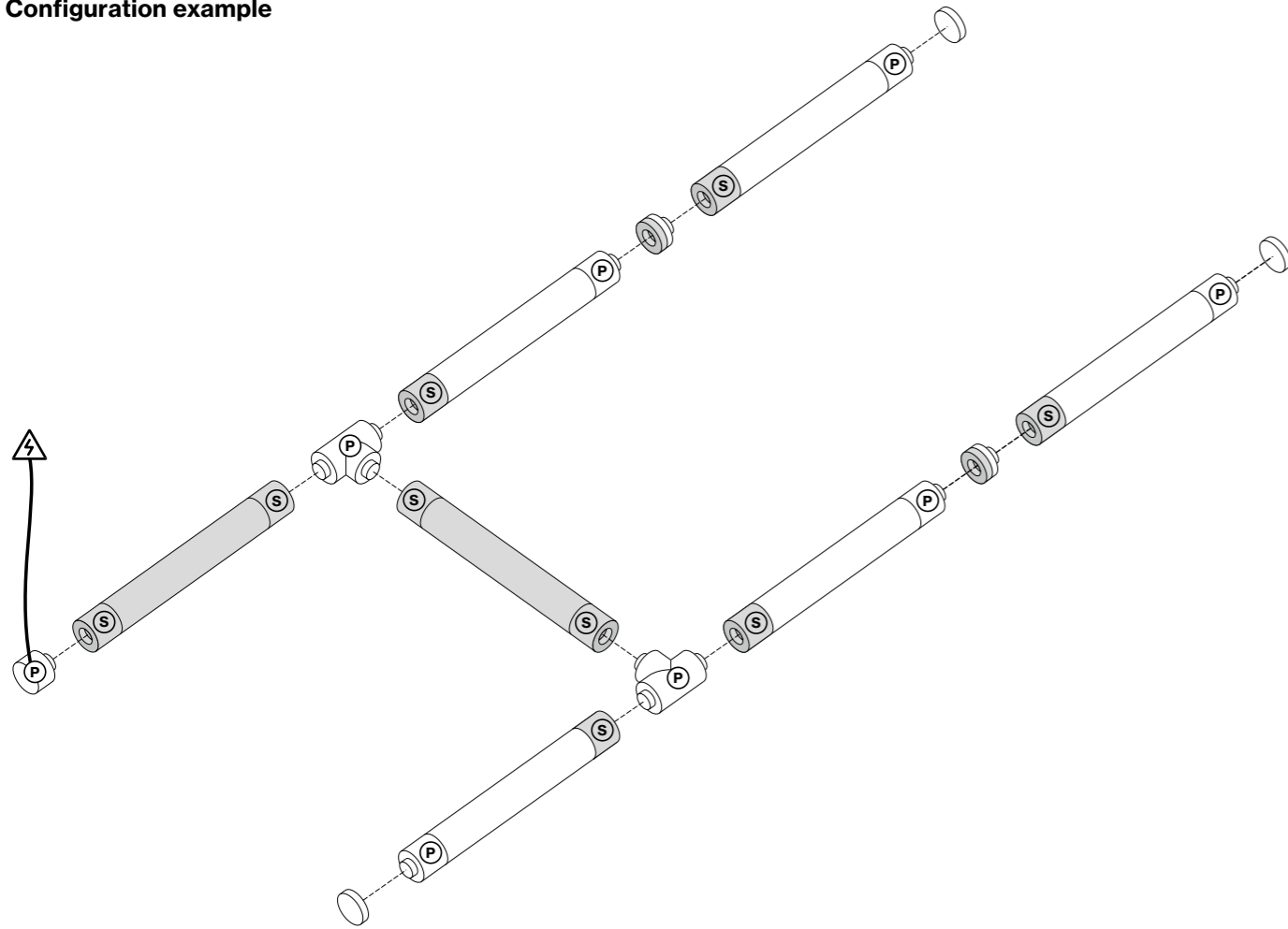

**Components**

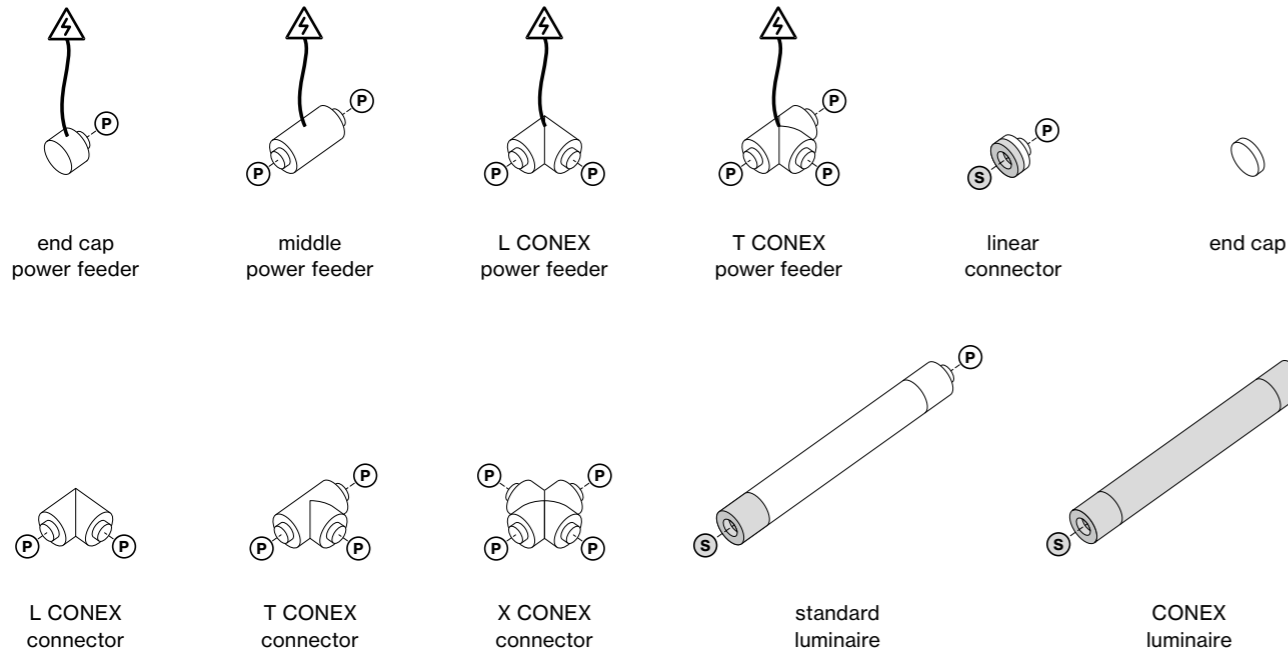

**Order options**

MATERIAL COLOUR	
○ pure white RAL 9010	7
● jet black RAL 9005	8

MATERIAL COLOUR	
CABLE SUSPENSION	
∕ chrome	0
● black	8

**Accessories**

END CAP		ORDER CODE
TYPE	end cap	058-301001

POWER FEEDER SURFACE		ORDER CODE
TYPE	end cap power feeder	058-301021
	middle power feeder*	058-301121

\*incl. feeder cable 5 × 1.5 mm<sup>2</sup>

POWER FEEDER SUSPENDED incl. feeder cable 5 × 1.5 mm <sup>2</sup>		
TYPE	L (mm)	ORDER CODE
end cap power feeder	1500	058-301041
middle power feeder*	1500	058-301131
L CONEX power feeder**	1500	058-301873
T CONEX power feeder**	1500	058-301883

\*order cable suspension separately; \*\*order CONEX cable suspension separately

LINEAR CONNECTOR		ORDER CODE
TYPE	linear connector mechanical	058-301311
	linear connector mechanical & electrical	058-301312

LINEAR CONNECTOR SUSPENDED incl. cable suspension 1500 mm		ORDER CODE
TYPE	linear connector mechanical	058-301321
	linear connector mech. & electr.	058-301322

CONEX CONNECTOR		ORDER CODE
TYPE	L CONEX connector mech. & electr.	058-301872
	T CONEX connector mech. & electr.	058-301882
	X CONEX connector mech. & electr.	058-301892

order CONEX cable suspension separately

MOUNTING SET		ORDER CODE
TYPE	ceiling mounting set	058-301411
	cable suspension	058-301421
	cable suspension angular max. 60°	058-301431
	CONEX cable suspension	058-301811

CANOPY		ORDER CODE
TYPE	canopy	005-260003

for electrical system configuration see luminaire data sheet at xal.com

SENSOR DALI-2		ORDER CODE
TYPE	ESSENTIAL (brightness & presence)	058-301911
	SENSE (brightness, presence, temperature, sound pressure, humidity, CO <sub>2</sub> )	058-301921

XAL Headquarters Graz, AT

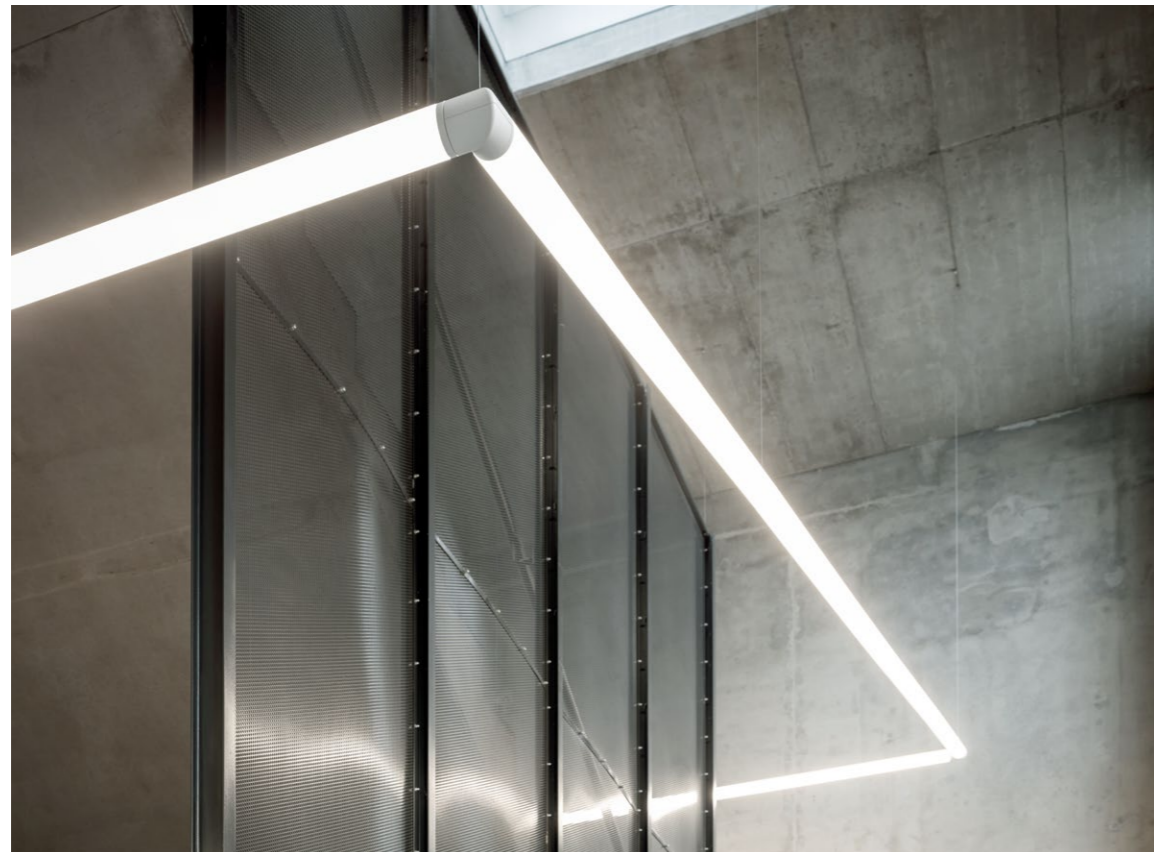
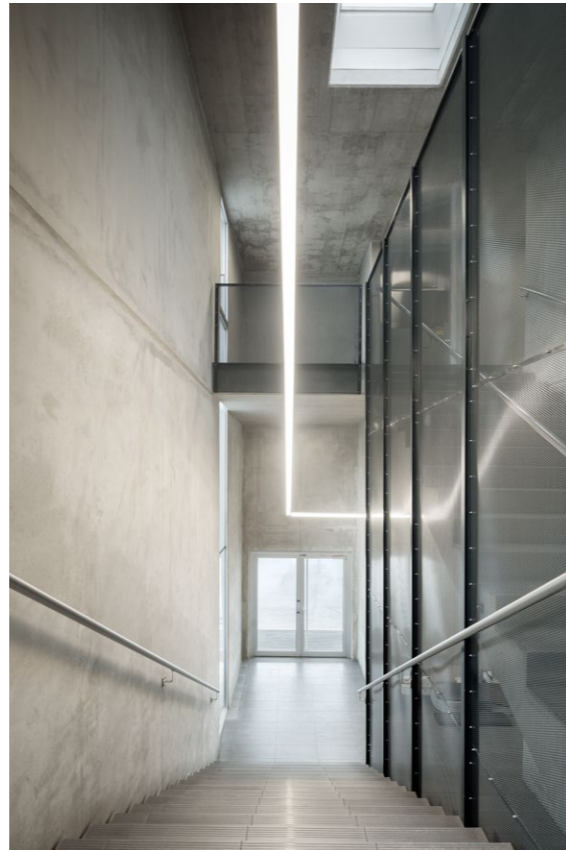

# Discreet perfection



## MITA

**EN** MITA combines high performance with a slim design language and its wide range of applications is impressive. The product family is available as recessed or surface-mounted luminaire in a round or square design as well as suspended version. All the versions of the luminaire have special reflectors for the best screen-compatible work lighting – perfect for use in offices or meeting rooms. The product family is available in the light colours 3000K, 4000K, or Tunable White. Optionally, the luminaire can be equipped with a presence and brightness sensor.

**ES** MITA aúna la potencia con un lenguaje de formas estilizado y cautiva por sus múltiples posibilidades de uso. La familia de productos incluye luminarias empotrables y de superficie en variantes redondas o cuadradas, así como una variante de suspensión. En todos sus modelos, esta luminaria dispone de unos reflectores especiales que proporcionan la mejor luz de trabajo para el uso de pantallas de visualización, por lo que es perfecta para la utilización en oficinas y salas de reuniones. La familia de productos está disponible en temperaturas de color de 3000 K y 4000 K o como opción Tunable White. La luminaria puede equiparse opcionalmente con un sensor de presencia y luminosidad.

### Types

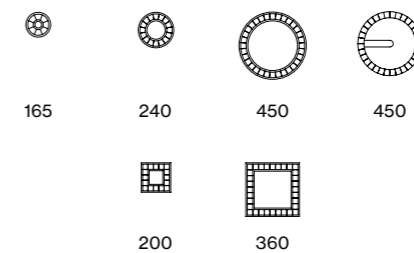

### Mountings

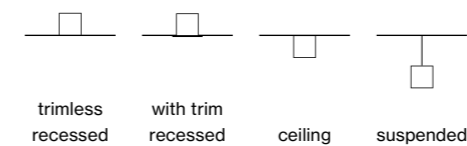

### Light distributions

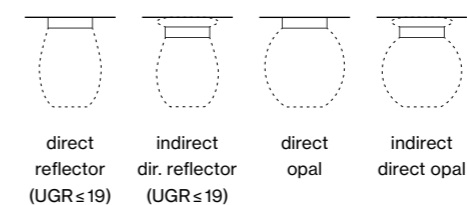



## Variety

EN MITA is characterised by an elegant design language with maximum efficiency and versatile application possibilities. The MITA product family is available as a recessed or surface-mounted luminaire in round and square versions, as well as a suspended variant. For a uniform ceiling appearance, the cover can simply be attached magnetically and is available as a reflector or opal cover.

ES MITA ofrece un lenguaje de formas elegante unido a la máxima eficiencia, y destaca por sus múltiples posibilidades de uso. La familia de productos MITA consta de luminarias empotrables o de superficie en variantes redondas, cuadradas y de suspensión. Para conseguir un patrón de techo uniforme, el difusor puede fijarse magnéticamente de un modo fácil y está disponible como variante de reflector o de cubierta opal.

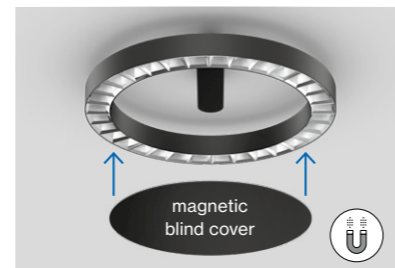

## Advanced sensor technology

EN Special sensors expand the MITA product family with smart lighting control and collection of insightful data. The ESSENTIAL sensor enables dynamic adjustment of the lighting to ambient brightness and room activity. The SENSE sensor also measures values such as temperature, air quality, humidity and noise level. These data not only provide important insights into the ambient conditions and use of rooms, but also support energy savings in the long term.



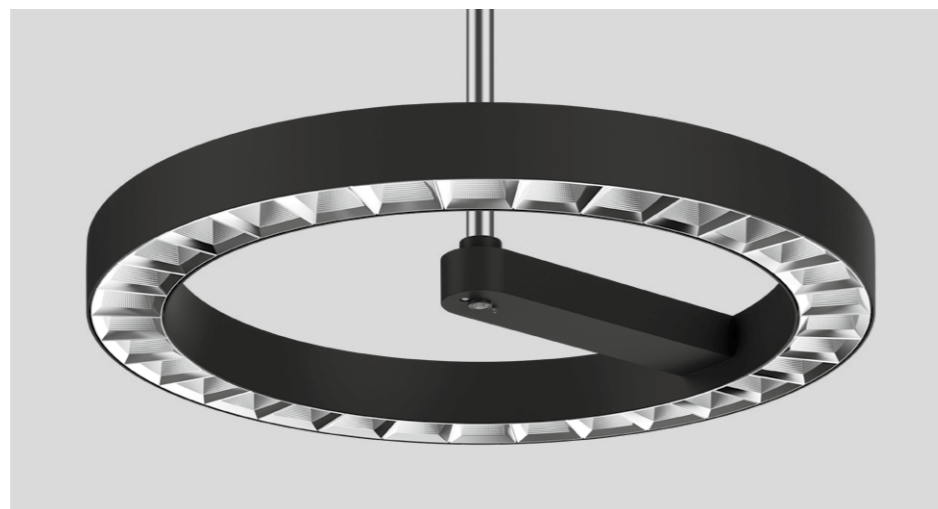



ES Unos sensores especiales amplían la familia de productos MITA con un control inteligente de la iluminación. El sensor ESSENTIAL permite adaptar la luz dinámicamente a la luminosidad del entorno y a la actividad de la sala. El sensor SENSE mide además valores como la temperatura, la calidad y humedad del aire y el nivel de ruido. Estos datos no solo ofrecen información importante sobre las condiciones ambientales y el uso de las salas, sino también fomentan el ahorro energético de un modo duradero.



### ESSENTIAL sensor

-  brightness
-  presence

### SENSE sensor

-  brightness
-  presence
-  temperature
-  humidity
-  sound pressure
-  CO<sub>2</sub>

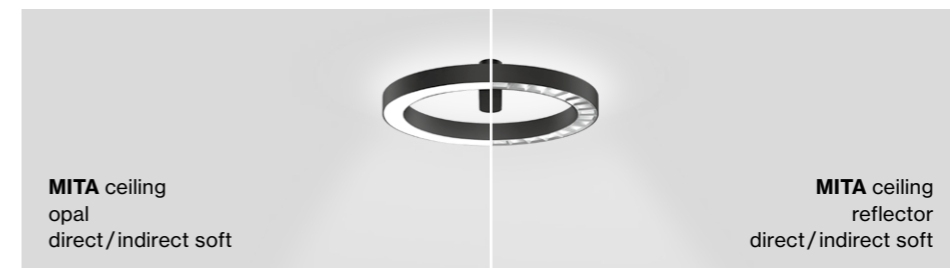
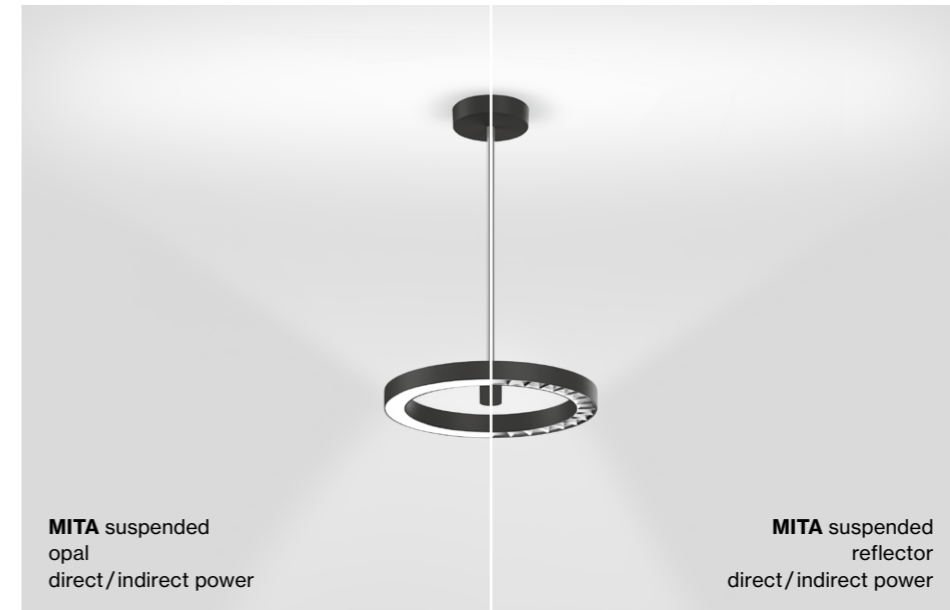

## Light distribution

EN As an office luminaire, MITA guarantees the best possible working light. Special, glare-reduced reflectors direct the light precisely onto the work surface and reduce reflections. The opal cover ensures homogeneous room illumination. With the direct/indirect power version of the suspended luminaire, the indirect light component has a very wide beam and distributes the light evenly across the ceiling. The direct/indirect soft light component of the surface-mounted version produces a gentle and light ceiling illumination, making the luminaire appear to almost float.

ES Como luminaria de oficina, MITA garantiza la mejor luz para trabajar. Unos reflectores especiales antideslumbramiento dirigen la luz con precisión a la superficie de trabajo y reducen los reflejos. Con el difusor opal se consigue una iluminación general homogénea. En la luminaria de suspensión con iluminación directa/indirecta «power», el componente de luz indirecta posee un ángulo de apertura muy amplio y distribuye la luz en el techo de manera homogénea. El componente de luz directa/indirecta «soft» de la variante de superficie genera un alumbrado suave y ligero del techo y dota a la luminaria de una apariencia casi flotante.



## Discreet accentuation

EN MITA sets discreet accents for a pleasant room atmosphere. The product is available in black or white, and with or without a cover. The magnetic cover attaches easily and the indirect component provides gentle and light ceiling brightening.

ES MITA ceiling establece acentos discretos para obtener una atmósfera interior agradable. Está disponible en color negro o blanco y se ofrece opcionalmente con difusor, el cual se fija fácilmente de forma magnética. La proporción de luz indirecta genera un alumbrado suave y ligero del techo y dota a la luminaria de una apariencia casi flotante.

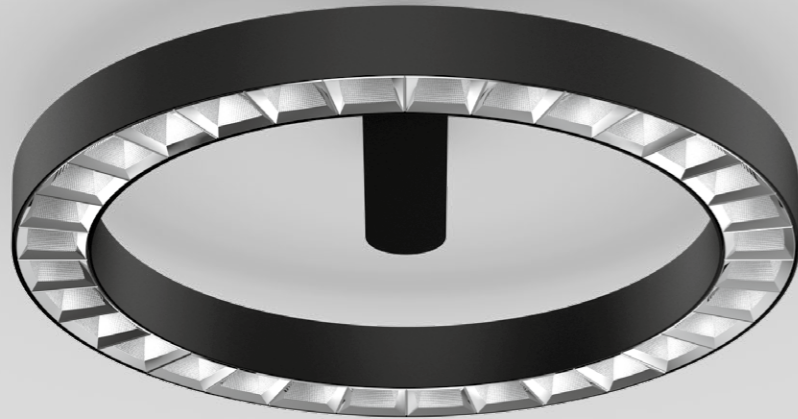

## MITA circle

ceiling

**EN** Ring shaped luminaire housing in die-cast aluminium; extremely slim design; surface powder coated; luminaire housing set away from ceiling; electronic operating unit installed in the surface mounted housing; surface mounted housing aligned from the ring to the center; optional: blind cover to cover the cut-out, held by magnet, available as an accessory; high-gloss reflector with faceted design; HPO (High Performance Opal) cover for uniform illumination; either with direct or direct/indirect light distribution; energy-efficient LEDs with very good colour rendering

**ES** Cuerpo con forma de anillo y fabricado en aluminio; forma extremadamente esbelta; superficie con recubrimiento de pintura en polvo; cuerpo luminoso separado del techo; balasto electrónico integrado en la carcasa de superficie; carcasa superf. alineada desde anillo hasta centro; opcional: cubierta opaca de fijación a recorte de techo con imán disponible como accesorio adicional; reflector de alto brillo con óptica facetada; difusor opal de alta calidad que proporciona una iluminación uniforme; opcionalmente con característica de emisión directa o directa/indirecta; LEDs de alta eficiencia que proporcionan una alta reproducción cromática

### Quickinfo

3000K, 4000K  
CRI ≥ 80, 3 SDCM  
UGR ≤ 19 / 65° ≤ 1500 cd/m<sup>2</sup>  
up to 158 lm/W  
L90 @ 50 000h  
DALI-2, DALI-2 sensor  
reflector (UGR ≤ 19), opal

### Types

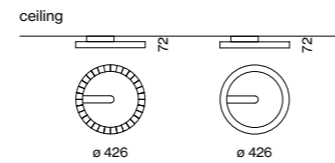

### Colours



### Light distributions



dark chrome  
reflector option



up to 158 lm/W  
(high efficiency)

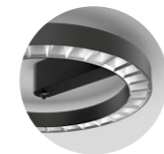

sensor version  
available



version with  
opal cover



magnetic  
blind cover



DIN EN 12464-1  
UGR ≤ 19

### Order options

COLOUR TEMPERATURE	
3000K	5
4000K	6

CONTROL	
DALI-2	3
DALI-2 ESSENTIAL sensor (brightness & presence)	B
DALI-2 SENSE sensor (brightness, presence, temp., sound pressure, humidity, CO <sub>2</sub> )	P

MATERIAL COLOUR	
○ traffic white RAL 9016	7
● jet black RAL 9005	8

REFLECTOR COLOUR	
◊ chrome	R
● dark chrome	B

LIGHT OPTIC COVER	
reflector (UGR ≤ 19)	
opal	

### Options on request

COLOUR RENDERING INDEX	
CRI ≥ 90	

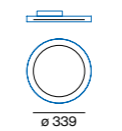
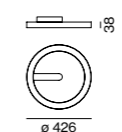
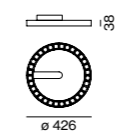
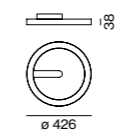
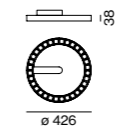

### MITA circle 450 ceiling



#### REFLECTOR DIRECT

SYSTEM POWER	COLOUR TEMP.	LUMINOUS FLUX	ORDER CODE
30W	3000K	4210 lm	074-75111
	4000K	4790 lm	
40W	3000K	5470 lm	074-75211
	4000K	6230 lm	

#### OPAL DIRECT

SYSTEM POWER	COLOUR TEMP.	LUMINOUS FLUX	ORDER CODE
24.9W	3000K	2770 lm	074-75111
	4000K	3150 lm	



#### REFLECTOR DIRECT / INDIRECT SOFT

SYSTEM POWER	COLOUR TEMP.	LUMINOUS FLUX	ORDER CODE
30W	3000K	↓ 4220 / ± 72lm	074-75311
	4000K	↓ 4800 / ± 82lm	
40W	3000K	↓ 5490 / ± 94lm	074-75611
	4000K	↓ 6240 / ± 107lm	

#### OPAL DIRECT / INDIRECT SOFT

SYSTEM POWER	COLOUR TEMP.	LUMINOUS FLUX	ORDER CODE
24.9W	3000K	↓ 2700 / ± 136lm	074-75311
	4000K	↓ 3080 / ± 155lm	

### Accessories

#### BLIND COVER

TYPE	ORDER CODE
MITA circle 450 ceiling	074-891162
MITA circle 450 ceiling sensor	074-891163

### Light distribution

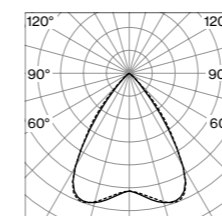

reflector (UGR ≤ 19)  
direct

**LUMINOUS FLUX** value calculated for  
CRI ≥ 80, colour white, reflector chrome

**Meeting room**  
Visualisation



**Hallway**  
Visualisation







## MITA circle

suspended

**EN** Ring shaped luminaire housing in die-cast aluminium; extremely slim design; surface powder coated; suspended; with height adjustable rod suspension (chrome), feed in rod; electronic operating unit installed in the canopy; optional: blind cover to cover the cut-out, held by magnet, available as an accessory; high gloss reflector with faceted design; HPO (High Performance Opal) cover for uniform illumination; either with direct or indirect light distribution; energy-efficient LEDs with very good colour rendering

**ES** Cuerpo con forma de anillo y fabricado en aluminio; forma extremadamente esbelta; superficie con recubrimiento de pintura en polvo; suspendido; con suspensión acortable de tubo pendular (cromo), línea de alimentación en tubo pendular; driver instalado en el baldaquino; opcional: cubierta opaca de fijación a recorte de techo con imán disponible como accesorio adicional; reflector de alto brillo con óptica facetada; difusor opal de alta calidad que proporciona una iluminación uniforme; opcionalmente con característica de emisión directa o directa/indirecta; LEDs de alta eficiencia que proporcionan una alta reproducción cromática

### Quickinfo

3000K, 4000K  
CRI ≥ 80, 3 SDCM  
UGR ≤ 19 / 65° ≤ 1500 cd/m<sup>2</sup>  
up to 160 lm/W  
L90 @ 50 000 h  
DALI-2, DALI-2 sensor  
reflector (UGR ≤ 19), opal

### Types

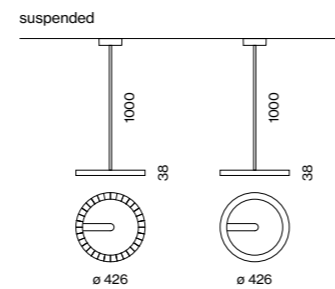

### Colours



### Light distributions

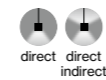

dark chrome  
reflector option



up to 160 lm/W  
(high efficiency)

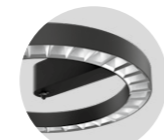

sensor version  
available



version with  
opal cover



magnetic  
blind cover



DIN EN 12464-1  
UGR ≤ 19

### Order options

**SUSPENSION**  
rod 1000 mm

**COLOUR TEMPERATURE**

3000K	5
4000K	6

**CONTROL**

DALI-2	3
DALI-2 ESSENTIAL sensor (brightness & presence)	B
DALI-2 SENSE sensor (brightness, presence, temp., sound pressure, humidity, CO <sub>2</sub> )	P

**MATERIAL COLOUR**

○ traffic white RAL 9016	7
● jet black RAL 9005	8

**REFLECTOR COLOUR**

▨ chrome	R
● dark chrome	B

**LIGHT OPTIC COVER**  
reflector (UGR ≤ 19)  
opal

### Options on request

**SUSPENSION**  
rod 1000 mm white  
rod 1000 mm black

**COLOUR RENDERING INDEX**  
CRI ≥ 90

**COLOUR TEMPERATURE**  
tunable white 2700–6500 K

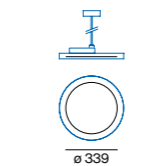
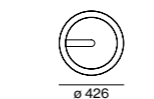
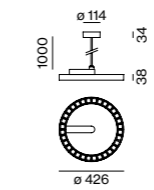
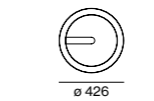
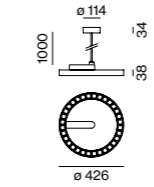

### MITA circle 450 suspended



#### REFLECTOR DIRECT

SYSTEM POWER	COLOUR TEMP.	LUMINOUS FLUX	ORDER CODE
30W	3000K	4210 lm	074-76111
41W	3000K	5470 lm	074-76211
	4000K	4790 lm	
	4000K	6230 lm	

#### OPAL DIRECT

SYSTEM POWER	COLOUR TEMP.	LUMINOUS FLUX	ORDER CODE
25.1W	3000K	2770 lm	074-76111
	4000K	3060 lm	



#### REFLECTOR DIRECT / INDIRECT POWER

SYSTEM POWER	COLOUR TEMP.	LUMINOUS FLUX	ORDER CODE
58W	3000K	↓ 4030 / ↑ 3780 lm	074-76511
	4000K	↓ 4600 / ↑ 4310 lm	

#### OPAL DIRECT / INDIRECT POWER

SYSTEM POWER	COLOUR TEMP.	LUMINOUS FLUX	ORDER CODE
58W	3000K	↓ 3140 / ↑ 3780 lm	074-76511
	4000K	↓ 3570 / ↑ 4310 lm	

### Accessories

#### BLIND COVER

TYPE	ORDER CODE
MITA circle 450 suspended	074-891162
MITA circle 450 suspended sensor	074-891163

**LUMINOUS FLUX** value calculated for  
CRI ≥ 80, colour white, reflector chrome

**ALLPLAN Österreich GmbH**  
Graz, AT



# Hidden talent



## SPIO

**EN** Round, recessed SPIO spotlights bring special lighting to your rooms. The luminaire provides an impressive lighting effect, trimless or with a trim. The housing can be painted over, allowing the spotlight to blend seamlessly into the ceiling. The small light aperture of 10 mm makes the SPIO itself appear almost hidden – but the equally effective and calm overall impression is anything but invisible. The round, recessed spotlight is available with beam angles of 35° or 44° and can be rotated 360° in the housing and pivoted 30° in all directions. In addition, SPIO 20 is available with Wallwasher Floor optic, which creates an uniform wall illumination. These different lighting options mean that versatile designs for interiors are possible. SPIO is available in the light colours 2700 K, 3000 K, and 4000 K.

**ES** Los focos empotrables redondos SPIO permiten disfrutar de una iluminación especial en cualquier sala. La luminaria proporciona un efecto luminoso impresionante, ya sea en la variante con marco o sin marco perimetral. La carcasa puede pintarse sin problemas, con lo que el foco se integra en el patrón de techo a la perfección. La reducida abertura de salida de luz de tan solo 10 mm hace que SPIO parezca casi oculta. No obstante, su aspecto global sosegado y a la vez vistoso es todo menos invisible. El spot empotrable redondo, disponible con un ángulo de apertura de 35° o 44°, puede girarse 360° en la carcasa e inclinarse a 30° en todas las direcciones. Además, SPIO 20 está disponible con una óptica de bañador de pared-suelo que ofrece un alumbrado homogéneo de las paredes. Esto hace posible una variada configuración del espacio con distintas posibilidades de iluminación. SPIO está disponible en temperaturas de color de 2700 K, 3000 K y 4000 K.

### Types

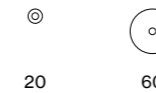

20

60

### Mountings

trimless  
recessedwith trim  
recessed

### Light distributions

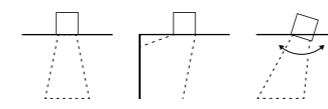

downlight

floor  
wallwasher

spotlight

## High-efficiency lens

**EN** Large light output – almost unnoticed. SPIO has a special LFO lens, which is mounted at an exact distance from the light-emission surface, thus ensuring that no light beam appears on the inner surface of the housing. This reduces the light-emission surface, and SPIO illuminates the room almost unnoticed.

**ES** Gran intensidad luminosa –pero casi imperceptible. SPIO dispone de una lente LFO especial que se monta a una distancia precisa respecto a la superficie emisora de luz. Esa distancia garantiza que ningún rayo de luz incida en el área interior de la carcasa y reduce la superficie de salida de luz, haciendo que la luminaria SPIO ilumine la sala de un modo casi imperceptible.

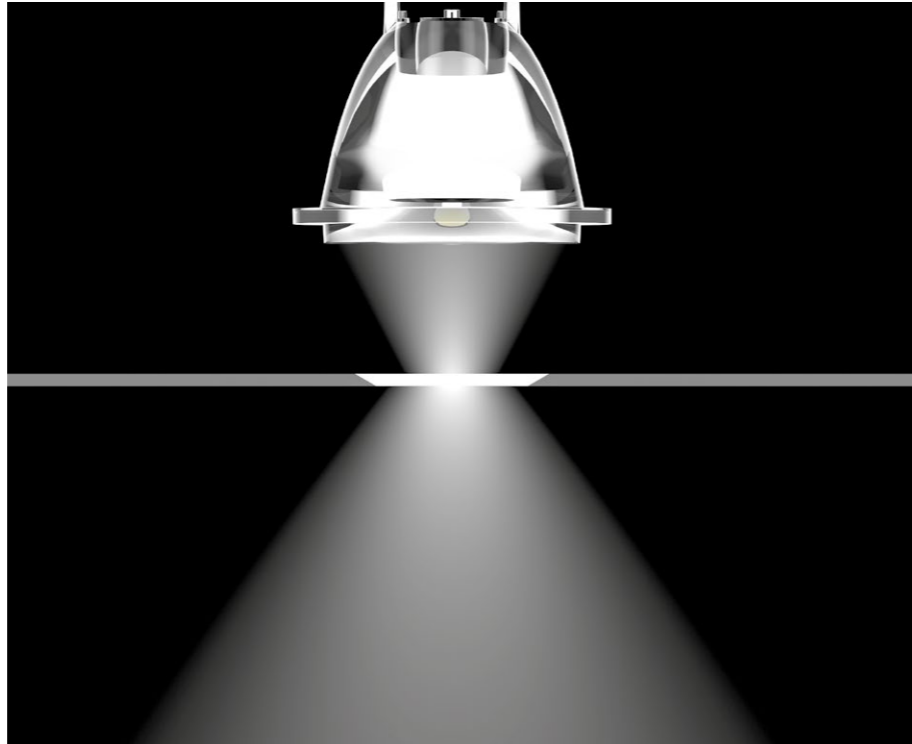

## Homogeneous appearance

**EN** SPIO is the right choice for a uniform ceiling appearance. Thanks to its extremely small light aperture of 10 mm, the recessed spotlight appears almost invisible. The effective lighting is rounded off by its minimalist design language.

**ES** SPIO es la elección correcta para un patrón de techo uniforme. La pequeña abertura de salida de luz de tan solo 10 mm hace que el foco empotrable sea casi invisible. Su eficaz efecto luminoso se completa con un lenguaje de formas minimalista.

## Light distribution

**EN** Despite its small emission surface, the recessed spotlight achieves a beam angle of either 35° or 44°. SPIO 20 is also available with Wallwasher Floor optic, which creates a homogeneous wall brightening effect. SPIO thus provides glare-free light and skilfully stages objects.

**ES** Pese a su superficie de salida reducida, el foco empotrable ofrece un ángulo de apertura de 35° o 44°. Además, SPIO 20 está disponible con una óptica de bañador de pared-suelo que hace posible un alumbrado homogéneo de las paredes. Con ello, SPIO ofrece una luz libre de deslumbramiento y pone en escena los objetos con habilidad.

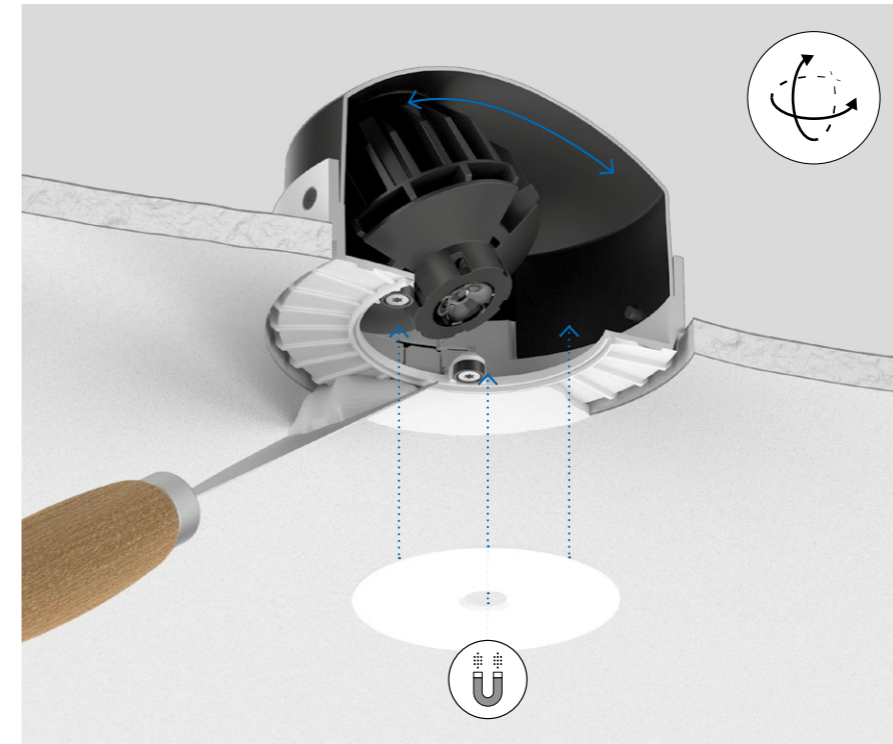
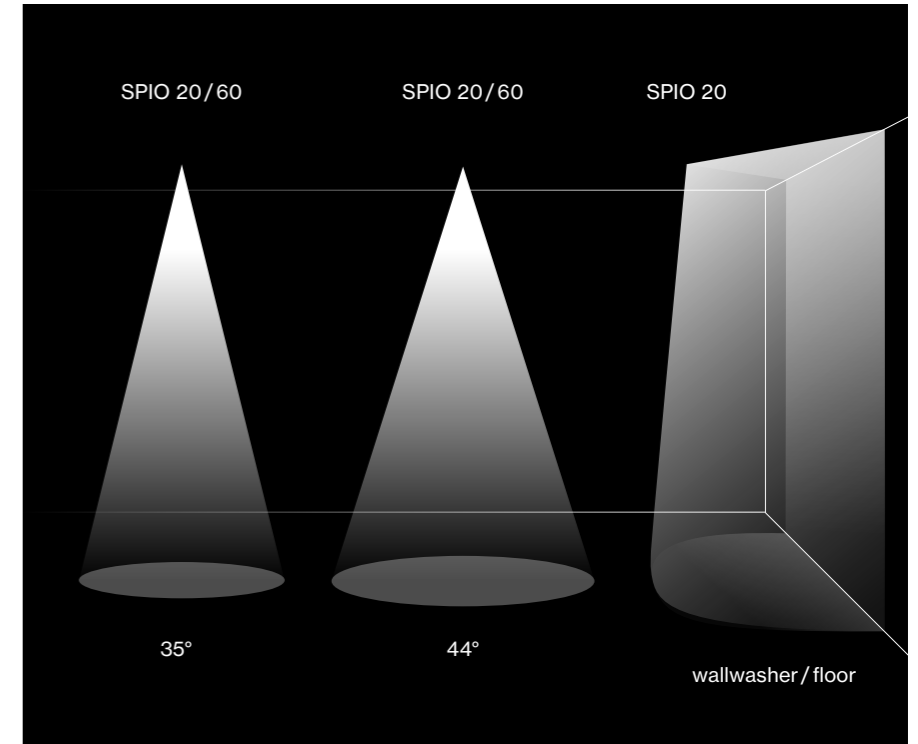

## Precise light adjustment

**EN** The adjustable version of SPIO 60, patent pending, can be moved in all directions thanks to a magnetic plate. The spotlight can thus both be rotated 360° and pivoted up to 30° in all directions. As a result, it offers the greatest flexibility in directing and guiding light exactly where it is desired.

**ES** La variante «adjustable» de SPIO 60 (en espera de patente) puede moverse en todas las direcciones gracias a su cabezal de proyección magnético. Esto hace que, además de girar 360°, el foco pueda inclinarse hasta 30° en cualquier dirección. Así es capaz de ofrecer la máxima flexibilidad de orientación y un direccionamiento de la luz exacto hasta el lugar deseado.

## Smooth and invisible

**EN** The trimless SPIO 60 version can easily be maintained and adjusted thanks to its magnetic cover. The spotlight is completely fitted into a plasterboard ceiling. The recessed housing and ceiling can subsequently be painted over. The spots thus appear "invisible", creating a homogeneous, effective overall impression.

**ES** La variante sin marco de SPIO 60 hace posible un ajuste y un mantenimiento sencillos a través de su placa cobradora magnética. El foco puede empotrarse completamente en una plancha de cartón yeso. La carcasa empotrada puede pintarse a continuación junto con el techo de la sala. De ese modo, los spots parecen «invisibles», ofreciendo una impresión general homogénea de gran efecto.

## SPIO 20

recessed

EN Round recessed spotlight in die-cast aluminium; installation without tools in mounting set with ball catch system or using snap spring closure; special mounting tool for easy installation of the trimless housing available as an accessory; for trimless installation in plasterboard ceilings; paintable light inset; shadow joint between light inset and mounting set optionally fillable; or with trim; with optional high quality lens system with precise radiation characteristic; or high quality, aluminium, vapour deposition coated reflector with faceted design; precise radiation characteristics with different beam angles; uncluttered ceiling look through recessed lighting level; reduced light-emitting surface - only  $\varnothing 10$  mm (DOWNLIGHT) or  $\varnothing 13$  mm (WALLWASHER/FLOOR); no multiple shadows; energy-eff. LEDs - very good colour rendering

ES Proyector empotrable redondo de inyección en aluminio; montaje sin herramienta en el kit de montaje mediante sistema de cierre de bola o resorte a presión; herramienta de montaje especial para la sencilla instalación de la carcasa sin bordes disponible como accesorio; para montaje sin marco en techos de yeso; inserto luminoso pintable; separación emplantable entre el inserto luminoso y el kit de montaje; o con borde alrededor; opcionalmente con sistema óptico de lentes de alta calidad con precisa característica de emisión; o reflector de alta calidad vaporizado de aluminio con revestimiento de facetas esféricas; característica de emisión precisa con diferentes ángulos de emisión; vista de techo con luminaria empotrada; superficie emisora de luz reducida - solo  $10\text{ mm } \varnothing$  (DOWNLIGHT) o  $13\text{ mm } \varnothing$  (WALLWASHER/FLOOR); no sombras múltiples; LED energét. efíc. - excelente reprod. crom.

### Quickinfo

2700 K, 3000 K  
CRI  $\geq 90$ , 3 SDCM  
up to 70 lm/W  
L95 @ 50 000 h  
non DIM, DALI-2

### Types

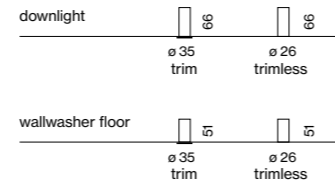

### Colours



### Light distributions



version with trim available



10 mm light output area



trimless installation

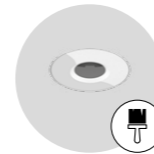

paintable cover

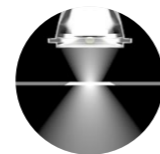

LFO lens technology

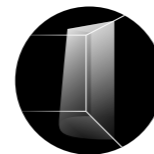

wallwasher floor

### Order options

<b>COLOUR TEMPERATURE</b>	☐☐☐
2700 K	4
3000 K	5

<b>MATERIAL COLOUR</b>	☑
○ traffic white RAL 9016	7
● jet black RAL 9005	8

<b>REFLECTOR COLOUR</b>	
● jet black RAL 9005	
paintable cover	

<b>BEAM ANGLE</b>	▲
flood 35°	F
wide flood 44°	W

### Options on request

<b>COLOUR RENDERING INDEX</b>	
CRI $\geq 95$ , 2 SDCM	

<b>COLOUR TEMPERATURE</b>	
4000 K	

<b>CONCRETE HOUSING</b>	
primed concrete ceiling	
exposed concrete ceiling	

<b>REFLECTOR COLOUR</b>	
○ traffic white* RAL9016	
*only for wallwasher / floor	

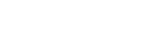
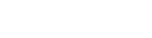
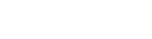

**INSET POWER** is the current consumption excluding any ballast  
**LUMINOUS FLUX** value calculated for 3000 K, CRI  $\geq 90$ , colour white, lens wide flood, 2700 K -3%

### SPIO 20 downlight



#### DOWNLIGHT TRIMLESS

<b>INSET POWER</b>	<b>LUMINOUS FLUX</b>	<b>ORDER CODE</b>
6.5W 12Vf 600mA	435lm	048-1710::10▲

#### TRIMLESS MOUNTING SET for plasterboard ceilings 9–25 mm

<b>COLOUR</b>	<b>ORDER CODE</b>
○ traffic white RAL9016	048-1698107

#### DOWNLIGHT TRIM

<b>INSET POWER</b>	<b>LUMINOUS FLUX</b>	<b>ORDER CODE</b>
6.5W 12Vf 600mA	435lm	048-1610::1▲

### SPIO 20 wallwasher / floor



#### WALLWASHER/FLOOR TRIMLESS

<b>INSET POWER</b>	<b>LUMINOUS FLUX</b>	<b>ORDER CODE</b>
5.9W 5.6Vf 1050mA	414lm	048-1730::108W

#### TRIMLESS MOUNTING SET for plasterboard ceilings 9–25 mm

<b>COLOUR</b>	<b>ORDER CODE</b>
○ traffic white RAL9016	048-1698107

#### WALLWASHER/FLOOR TRIM

<b>INSET POWER</b>	<b>LUMINOUS FLUX</b>	<b>ORDER CODE</b>
5.9W 5.6Vf 1050mA	414lm	048-1630::18W

### Mounting accessories

#### SPECIAL MOUNTING TOOL

<b>TYPE</b>	<b>Ø-H (mm)</b>	<b>ORDER CODE</b>
SPIO 20	73-107	048-1690000

necessary to install mounting housing trimless

### Electrical accessories

#### POWER SUPPLY 220-240V AC, 50-60Hz, PC II

<b>TYPE</b>	<b>EFFICIENCY</b>	<b>L-W-H (mm)</b>	<b>ORDER CODE</b>
600 mA   max. 43 V   non DIM	$\eta$ 85 %	147-44-22	002-90783
600 mA   max. 46 V   DALI-2	$\eta$ 85 %	143-43-30	002-90784
1050 mA   max. 25 V   non DIM	$\eta$ 85 %	111-38-28	002-90787
1050 mA   max. 42 V   DALI-2	$\eta$ 85 %	143-43-30	002-90788

revision opening required

#### DIN RAIL COMPONENTS

<b>TYPE</b>	<b>W-H-D (mm)</b>	<b>ORDER CODE</b>
POWER SUPPLY 220-240 V AC	72-90-63	005-6520210
160 W   48V DC constant voltage		
LED DRIVER DALI-2 DT6 1-2 addr.	36-88-59	005-6121030
200-1050 mA settable const. current		
2 x 42 W   48 V DC   U <sub>OUT</sub> 10-40 V		

for more details and components see XAL 22 catalog, page 980

**Private Residence**  
Visualisation



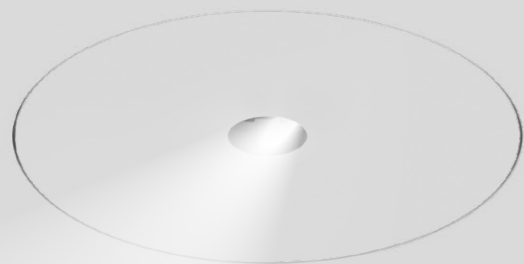

reddot winner 2022



## SPIO 60

recessed

**EN** Round recessed spotlight in die-cast aluminium; installation without tools in mounting set with ball catch system or with magnetic attachment; for trimless installation in plasterboard ceilings; paintable cover; shadow joint between cover and mounting set optionally fillable; or with trim; choice of adjustable or fixed symmetric radiation characteristic; high quality lens system; uncluttered ceiling look through recessed lighting level; reduced light-emitting surface (only  $\varnothing 10$  mm); no multiple shadows; efficient LEDs with very good colour rendering

**ES** Proyector empotrable redondo de inyección en aluminio; instalación sin herramientas mediante kit de montaje con sistema inserción de bola o con fijación magnética; para montaje sin marco en techos de yeso; placa cobertora pintable; separación emplastable entre la placa cobertora y el kit de montaje; o con borde alrededor; proyección simétrica fija o regulable; óptica de alta calidad; vista de techo con luminaria empotrada; superficie emis. de luz reducida (solo  $\varnothing 10$  mm); no sombras múltiples; LEDs de eficiencia que proporcionan una alta reproducción cromática

### Quickinfo

2700 K, 3000 K  
CRI  $\geq 90$ , 3 SDCM  
up to 60 lm/W  
L95 @ 50 000 h  
non DIM, DALI-2

### Types

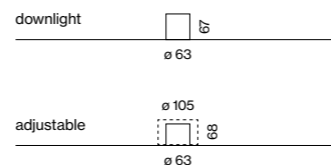

### Colours



### Light distributions



version with trim available



10 mm light output area



trimless installation

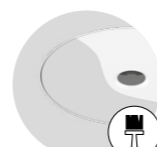

paintable cover

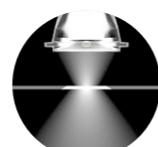

LFO lens technology

### Order options

COLOUR TEMPERATURE	
2700 K	4
3000 K	5

### MATERIAL COLOUR

traffic white RAL9016

paintable cover

### BEAM ANGLE

flood 35°	F
wide flood 44°	W

### Options on request

#### COLOUR TEMPERATURE

4000 K

#### CONCRETE HOUSING

primed concrete ceiling  
exposed concrete ceiling

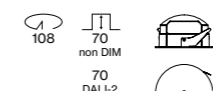
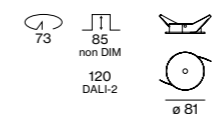

### SPIO 60 downlight



#### DOWNLIGHT

INSET POWER	LUMINOUS FLUX	ORDER CODE
11.9W 12Vf 1050mA	718lm	048-1510::17▲

### Mounting accessories

TRIMLESS MOUNTING SET for plasterboard ceilings 12.5/15/25 mm

COLOUR	ORDER CODE
<input type="radio"/> traffic white RAL9016	048-2696117

MOUNTING SET WITH TRIM for intermediate ceilings 2-25 mm

COLOUR	ORDER CODE
<input type="radio"/> traffic white RAL9016	048-1597207
<input checked="" type="radio"/> jet black RAL 9005	048-1597208

### SPIO 60 adjustable



#### ADJUSTABLE

INSET POWER	LUMINOUS FLUX	ORDER CODE
11.9W 12Vf 1050mA	685lm	048-1520::17▲

### Mounting accessories

TRIMLESS MOUNTING SET for plasterboard ceilings 12.5/15/25 mm

COLOUR	ORDER CODE
<input type="radio"/> traffic white RAL9016	048-1598107

MOUNTING SET WITH TRIM for intermediate ceilings 2-25 mm

COLOUR	ORDER CODE
<input type="radio"/> traffic white RAL9016	048-1597107
<input checked="" type="radio"/> jet black RAL 9005	048-1597108

### Electrical accessories

POWER SUPPLY 220-240 V AC, 50-60 Hz, PC II

TYPE	EFFICIENCY	L-W-H (mm)	ORDER CODE
1050 mA   non DIM	$\eta$ 85 %	111-38-28	002-90787
1050 mA   DALI-2	$\eta$ 85 %	143-43-30	002-90788

#### DIN RAIL COMPONENTS

TYPE	W-H-D (mm)	ORDER CODE
POWER SUPPLY 220-240 V AC	72-90-63	005-6520210
160W   48V DC constant voltage		
LED DRIVER DALI-2 DT6 1-2 addr.	36-88-59	005-6121030
200-1050 mA settable const. current		
2 x 42W   48V DC   U <sub>OUT</sub> 10-40V		

for more details and components see XAL 22 catalog, page 980

**INSET POWER** is the current consumption excluding any ballast  
**LUMINOUS FLUX** value calculated for 3000 K, CRI  $\geq 90$ , colour white, lens wide flood, 2700 K -5%

**Private Residence**  
Visualisation





# High-precision shelf lighting

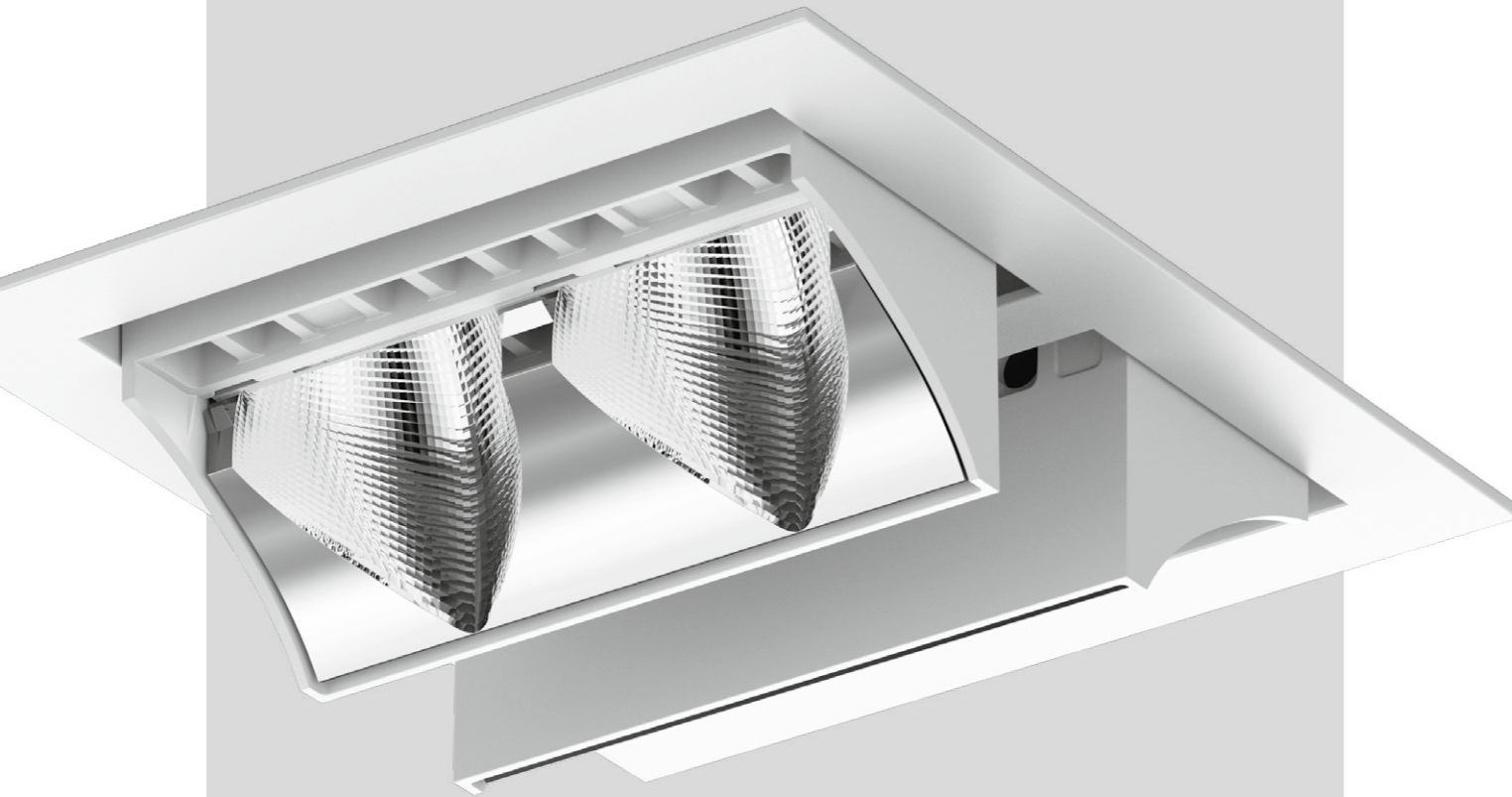

## SQUADRO

**EN** SQUADRO is a track-mounted and recessed spotlight, in a two-lamp single- or double-sided version, for the retail sector that bundles six essential retail requirements in one luminaire. Free-form reflectors with faceted optics make a polished presentation of goods possible. These reflectors direct the light precisely into shelves or aisle zones. Directed light creates a modelling effect on the products and delivers attractive staging. Swivelling light modules illuminate specific shelf levels or billboards while providing plenty of basic lighting. SQUADRO spotlights are completely glare-free, both transversely and longitudinally. They are highly efficient in their energy balance with an efficiency of over 90 %.

**ES** SQUADRO es una luminaria empotrable y de carril electrificado para el comercio minorista con una variante unilateral o bilateral de dos flujos de luz que combina seis importantes requisitos de las tiendas en una sola luminaria. La presentación brillante de artículos se consigue mediante reflectores de superficie compleja con óptica facetada: estos dirigen la luz con gran exactitud y precisión a los estantes y zonas de paso. La luz dirigida genera un efecto de modelado en los artículos, creando así una atractiva puesta en escena. Unos módulos de luz orientables iluminan con precisión niveles de estantes o paredes de carteles, a la vez que ofrecen una iluminación general suficiente. Las luminarias SQUADRO están completamente libres de deslumbramiento transversal y longitudinal, siendo además extremadamente eficientes en su balance energético con un rendimiento superior al 90 %.

### Types



single-sided 1x2    double-sided 2x2    single-sided 1x2    double-sided 2x2

### Mountings

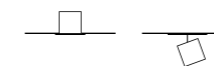

recessed    track

### Light distributions

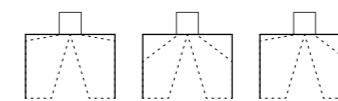

wall floor    shelf floor    wall/shelf floor

## 6-in-1 Lighting solution

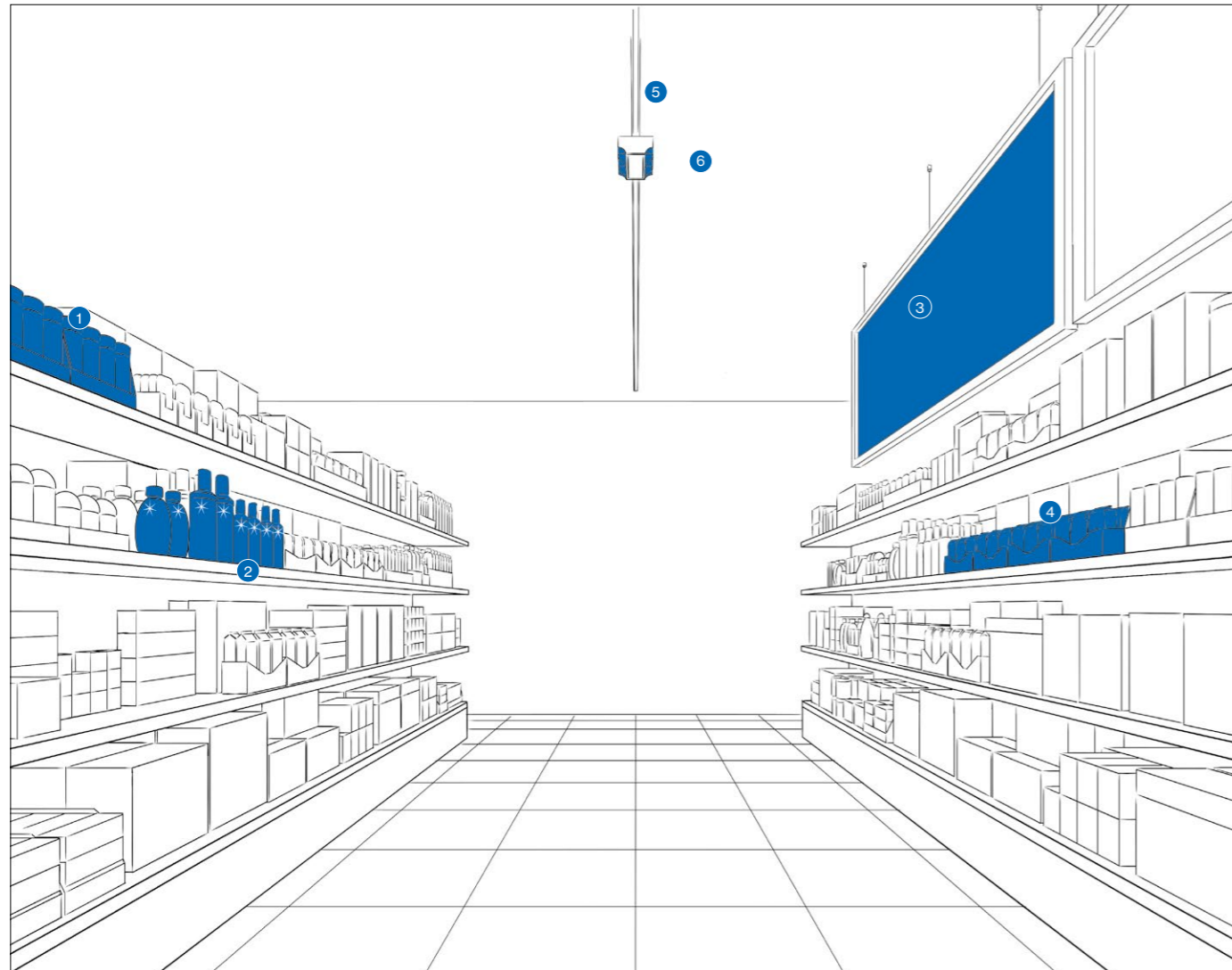

**EN** SQUADRO combines all the advantages of traditional retail lighting solutions in one luminaire. The spotlights are transversely and longitudinally glare-free and direct the light precisely onto the goods – into the heights and depths of the shelves. This achieves a strong product presentation. Thanks to proper light distribution, no additional light source is required for basic lighting.

**ES** SQUADRO combina todas las ventajas de las soluciones de iluminación clásicas para tiendas en una sola luminaria. Los proyectores exentos de deslumbramiento transversal y longitudinal dirigen la luz a los artículos, abarcando toda la altura y profundidad de las estanterías. Esto garantiza una presentación de productos eficaz. Su óptima distribución luminosa permite renunciar al uso de fuentes de luz adicionales para la iluminación general.

**1** **EN** The highest illuminance is on the upper two presentation levels.

**ES** La máxima intensidad luminosa se obtiene en los dos planos de presentación superiores.

**2** **EN** Highlights on premium goods create a brilliant staging.

**ES** Ópticas de una altísima calidad lumínica dan vida a toda la estantería.

**3** **EN** Directed light creates accents on billboards and subjects.

**ES** Una luz bien dirigida crea acentos en paneles publicitarios y reclamos.

**4** **EN** The high depth effect gives food high colour contrasts and attractiveness.

**ES** El gran efecto de profundidad dota a los alimentos de contrastes de color elevados y zonas puntuales de mayor brillo.

**5** **EN** Due to longitudinal glare control, the lighting system is barely perceptible to the customer in the direction of the aisle.

**ES** Ausencia de deslumbramiento = Comfort visual para el cliente.

**6** **EN** Transverse glare control additionally prevents glare from any viewing direction.

**ES** Además, la exención de deslumbramiento transversal impide que el cliente se deslumbrase desde cualquier dirección.

## Five versions

**EN** SQUADRO's five variants with diverse beam characteristics respond to different shop layouts and requirements. Perfect alignment ensures that minimal luminaires radiate as much light as possible onto the merchandise. SQUADRO adapts to the conditions and illuminates selectively and without scatter loss. All goods are thus attractively presented regardless of the size or interior design of the shop.

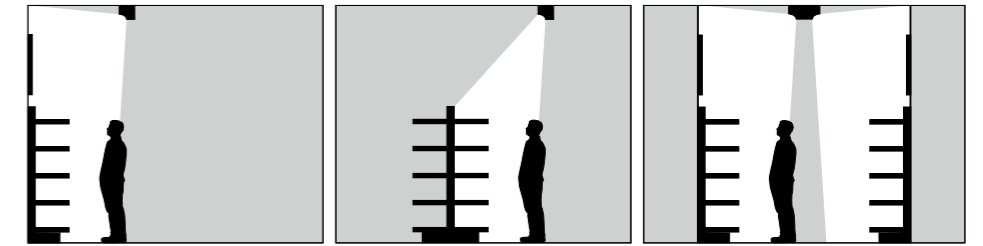

Wall Floor (single-side)

Shelf Floor (single-side)

Wall Floor (double-side)

**ES** SQUADRO se adapta a los diversos requisitos y distribuciones de las tiendas con sus cinco variantes dotadas de distintos modos de proyección. La orientación perfecta garantiza que un pequeño número de luminarias puedan proyectar la máxima luz posible sobre los artículos. SQUADRO se adapta a las necesidades específicas del espacio, ofreciendo una iluminación puntual y sin pérdidas por dispersión. Así, todos los artículos pueden presentarse de un modo atractivo, independientemente del tamaño o de la arquitectura interior de la tienda.

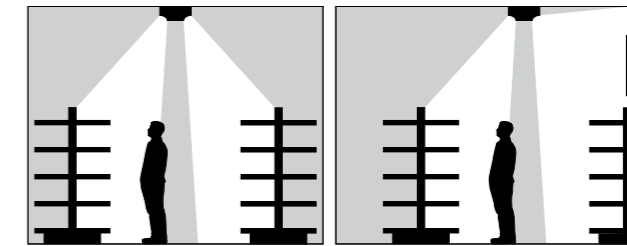

Shelf Floor (double-side)

Shelf / Wall Floor

## Unique reflector technology

**EN** Custom free-form reflectors ensure high-precision light control; each SQUADRO achieves an efficiency of over 90 per cent. The spotlights enjoy optimum glare control through the curved shape and secondary reflector technology.

**ES** Los reflectores proporcionan un direccionamiento de la luz extremadamente preciso. Cada SQUADRO ofrece un rendimiento luminoso superior al 90 por ciento. La forma y la tecnología de reflectores de los proyectores garantizan una óptima prevención del deslumbramiento.

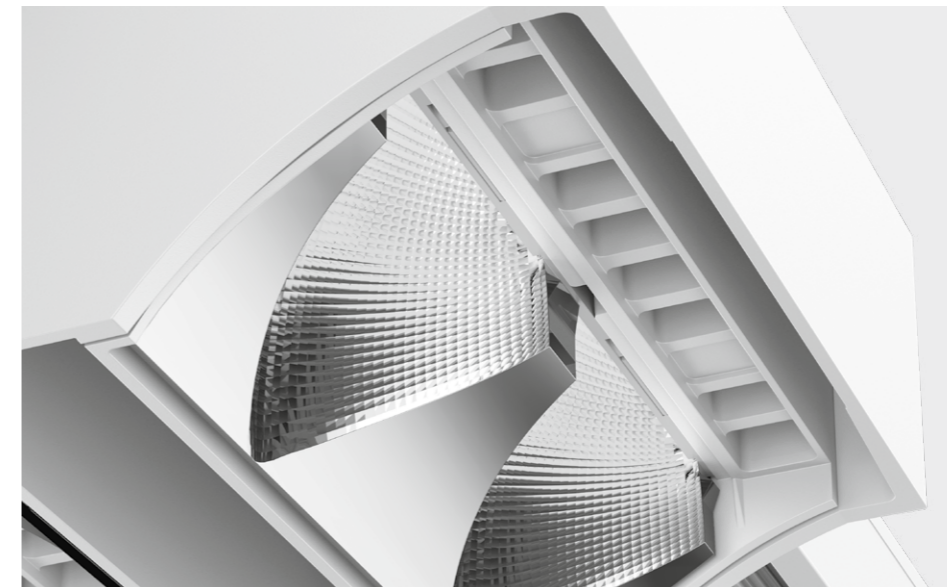

## Effective lighting

**EN** Branches of the same chain often differ in their shop architecture. Shelf heights and aisle widths may vary from one location to another. The solution is step-adjustable light modules. The elements can be tilted from  $-15^\circ$  to  $+20^\circ$ . Each module can be tilted asymmetrically, allowing precise alignment and thus optimum light control.

**ES** Cada tienda cuenta con un tamaño, distribución y una altura de techo distinta. Las alturas de los estantes y las anchuras de los pasillos pueden variar en función de la ubicación. Para resolver este problema, los módulos de iluminación ajustables ofrecen la solución perfecta. Estos elementos pueden bascular de  $-15^\circ$  a  $+20^\circ$  y cada módulo puede ser inclinado de manera asimétrica, haciendo posible una orientación precisa y un direccionamiento óptimo de la luz.



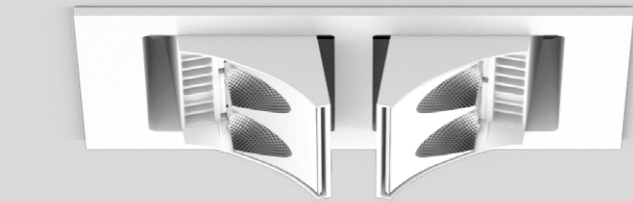
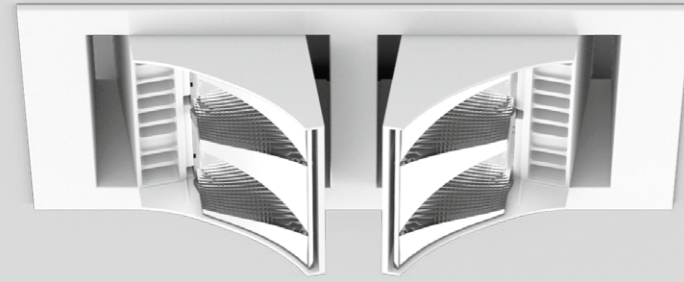

## SQUADRO wallwasher

recessed

EN Recessed ceiling spotlight in die cast aluminium in two different types (2 lamps or 2 x 2 lamps) and with 2 types of light modules (for shelf floor washer and wall floor washer); with trim; surface powder coated; installation without tools using snap spring closure; aisle spotlight with special, multi-free-form, facet effect surface reflectors for high precision light control; precise shelf and aisle zone lighting, optimum longitudinal glare control for high viewing comfort in the aisle zone, adjustable light modules; COB (Chip on Board) technology for maximum efficiency; efficient LEDs with very good colour rendering; IP 40 protection glass available as an accessory

ES Proyector para empotrar en el techo de fundición de aluminio en 2 diferentes variantes y con 2 módulos de iluminación diferentes con marco; superficie con recubrimiento de pintura en polvo; sencilla instalación sin herramientas mediante un enganche elástico; Proyector para zonas de pasillos con reflectores especiales de múltiples superficies de formas libres con óptica facetada para una orientación de la luz sumamente precisa; iluminación precisa de estanterías y de zonas de pasillos, evitando de forma óptima el deslumbramiento longitudinal para un elevado confort visual en la zona del pasillo, módulos de iluminación ajustables; COB que proporciona una máxima eficiencia; LEDs de eficiencia que proporcionan una alta reproducción cromática; vidrio de protección IP40 disponible como accesorio

### Quickinfo

3000K, 4000K  
CRI ≥ 90, 3 SDCM  
up to 134lm/W  
L80 @ 50 000h  
non DIM, DALI-2

### Types

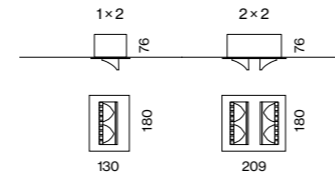

### Colours



### Light distributions

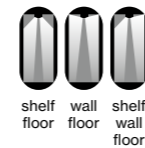

### Order options

COLOUR TEMPERATURE	
3000K	0
4000K	1

CONTROL	
non DIM	1
DALI-2	3

MATERIAL COLOUR	
○ traffic white RAL 9016	7
● jet black RAL 9005	8

REFLECTOR	
shelf floor washer	S
wall floor washer	A
1 x shelf / 1 x wall floor washer*	B

\*only for 2 x 2 lamps

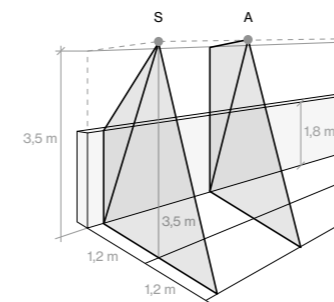

### Options on request

COLOUR RENDERING INDEX	
CRI ≥ 80	

### Light distributions

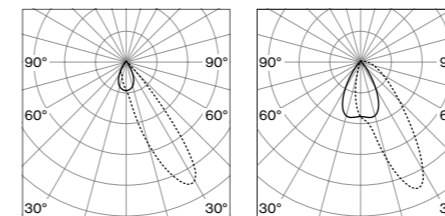

1 x 2 lamps  
shelf floor washer

1 x 2 lamps  
wall floor washer

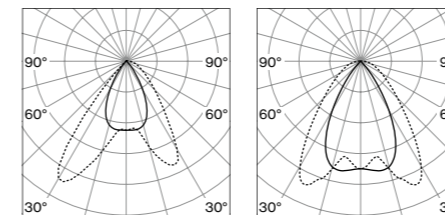

2 x 2 lamps  
1 x shelf / 1 x wall floor washer

2 x 2 lamps  
wall floor washer

LUMINOUS FLUX value calculated for 4000K  
CRI ≥ 90, colour white, wall floor washer  
3000K -5%

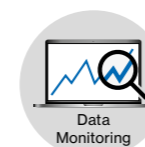

DiiA® standards  
251, 252, 253



up to 134 lm/W  
(high efficiency)

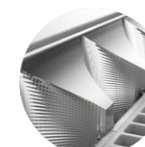

glare-free reflector  
longitudinally &  
transversely

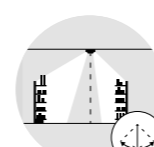

+20° up to -10°  
tiltable

### SQUADRO wallwasher trim



#### 1 x 2 LAMPS SINGLE-SIDED

SYSTEM POWER	LUMINOUS FLUX	ORDER CODE
36 W	4720 lm	049-2012



#### 2 x 2 LAMPS DOUBLE-SIDED

SYSTEM POWER	LUMINOUS FLUX	ORDER CODE
72 W	2 x 4720 lm	049-2020

### Optical accessories

#### IP 40 PROTECTION GLASS

TYPE		ORDER CODE
1 x 2 lamps/single-sided		049-2910010
2 x 2 lamps/double-sided		049-2920010

### Technical data

#### SQUADRO 1 x 2 lamps, shelf wall washer, trim, 36W, 3000K

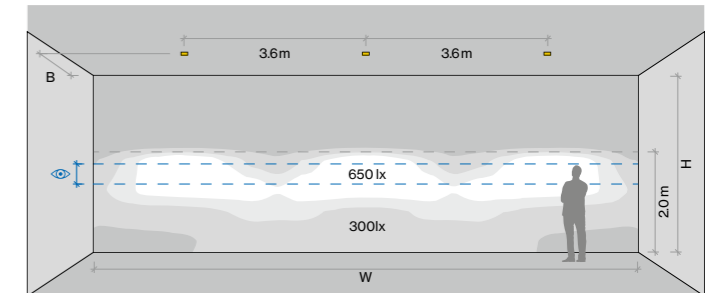

#### SQUADRO 1 x 2 lamps, wall floor washer, trim, 36W, 3000K

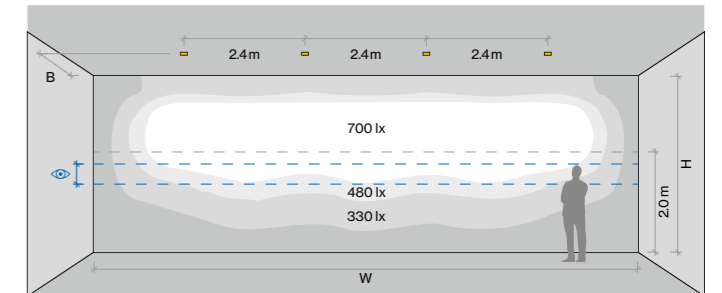

ROOM VALUES		CALCULATION SURFACE	
Wall dimensions	H = 3.5 m   W = 10.8 m	Surface dimensions	10.8 x 3.5 m
Distance to wall	B = 1.3 m	Surface height	0 - 3.5 m
Aisle width	2.6 m		
Reflection factor	0.7   0.7   0.2	Eye level	1.35 m - 1.75 m
Maintenance factor	0.9		

**Euroshop** Dusseldorf, DE –  
by blocher partners





## SQUADRO wallwasher

track

**EN** Track light in die cast aluminium in two different types (2 lamps or 2 × 2 lamps) and with 2 types of light modules (for shelf floor washer and wall floor washer); surface powder coated; aisle spotlight with special, multi-free-form, facet effect surface reflectors for high precision light control; precise shelf and aisle zone lighting, optimum longitudinal glare control for high viewing comfort in the aisle zone, adjustable light modules; COB (Chip on Board) technology for maximum efficiency; efficient LEDs with very good colour rendering; IP 40 protection glass available as an accessory; including attachment for linear alignment of the spotlights

**ES** Proyector en rail electrificado de fundición de aluminio en 2 diferentes variantes y con 2 módulos de iluminación diferentes; superficie con recubrimiento de pintura en polvo; Proyector para zonas de pasillos con reflectores especiales de múltiples superficies de formas libres con óptica facetada para una orientación de la luz sumamente precisa; iluminación precisa de estanterías y de zonas de pasillos, evitando de forma óptima el deslumbramiento longitudinal para un elevado confort visual en la zona del pasillo, módulos de iluminación ajustables; COB que proporciona una máxima eficiencia; LEDs de eficiencia que proporcionan una alta reproducción cromática; vidrio de protección IP 40 disponible como accesorio; incluye accesorio para la correcta alineación de la luminaria

### Quickinfo

3000K, 4000K  
CRI ≥ 90, 3 SDCM  
up to 134lm/W  
L80 @ 50 000 h  
non DIM, DALI-2

### Types

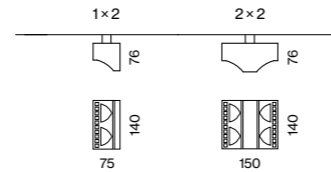

### Colours



### Light distributions



shelf floor  
wall floor  
shelf wall floor

### Order options

COLOUR TEMPERATURE	
3000K	0
4000K	1

CONTROL	
non DIM	1
DALI-2	3

MATERIAL COLOUR	
○ traffic white RAL 9016	7
● jet black RAL 9005	8

REFLECTOR	
shelf floor washer	S
wall floor washer	A
1 × shelf / 1 × wall floor washer*	B

\*only for 2 × 2 lamps

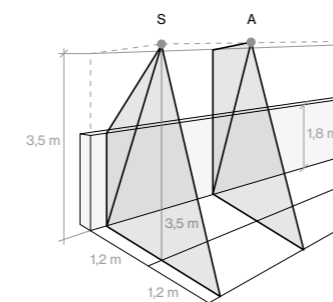

### Options on request

COLOUR RENDERING INDEX	
CRI ≥ 80	

CONTROL	
DALI-2 (2 × 2 lamps)	

### Light distributions

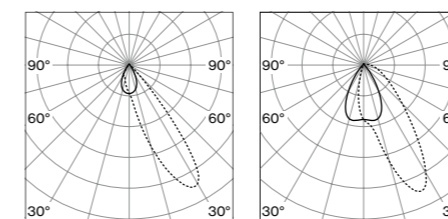

1 × 2 lamps  
shelf floor washer

1 × 2 lamps  
wall floor washer

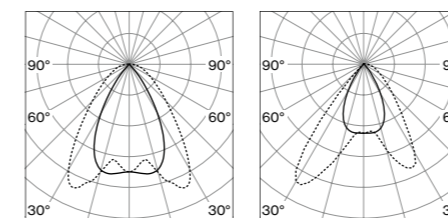

2 × 2 lamps  
wall floor washer

2 × 2 lamps  
1 × shelf / 1 × wall floor washer

**LUMINOUS FLUX** value calculated for 4000K  
CRI ≥ 90, colour white, wall floor washer  
3000K -5%

### SQUADRO wallwasher track

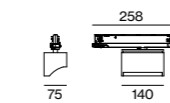

#### 1 × 2 LAMPS SINGLE-SIDED

SYSTEM POWER	LUMINOUS FLUX	ORDER CODE
36W	4720 lm	149-2210

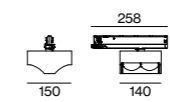

#### 2 × 2 LAMPS DOUBLE-SIDED

SYSTEM POWER	LUMINOUS FLUX	ORDER CODE
72W	2 × 4720 lm	149-2220

### Optical accessories

#### IP 40 PROTECTION GLASS

TYPE	ORDER CODE
1 × 2 lamps/single-sided	049-2910010
2 × 2 lamps/double-sided	049-2920010

### Technical data

#### SQUADRO 1 × 2 lamps, shelf wall washer, trim, 36W, 3000K

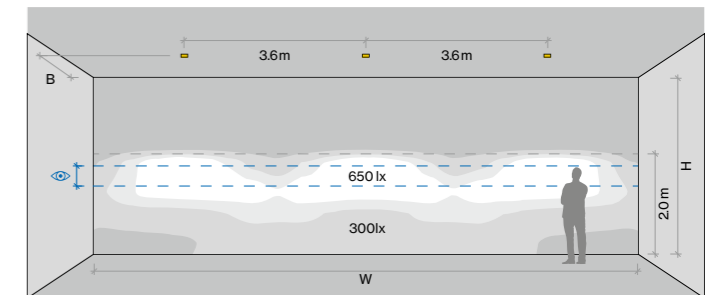

#### SQUADRO 1 × 2 lamps, wall floor washer, trim, 36W, 3000K

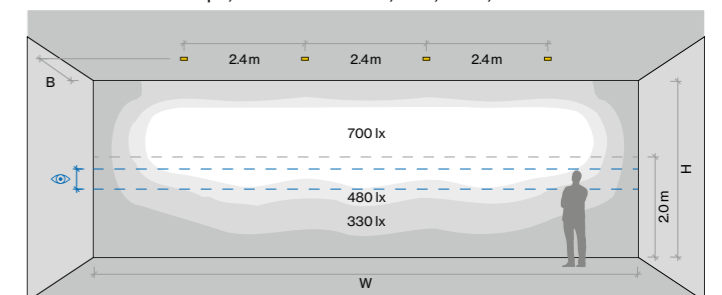

ROOM VALUES		CALCULATION SURFACE	
Wall dimensions	H = 3.5 m   W = 10.8 m	Surface dimensions	10.8 × 3.5 m
Distance to wall	B = 1.3 m	Surface height	0 – 3.5 m
Aisle width	2.6 m		
Reflection factor	0.7   0.7   0.2	Eye level	1.35 m – 1.75 m
Maintenance factor	0.9		

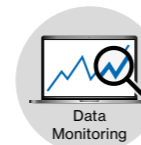

DiiA® standards  
251, 252, 253



up to 134 lm/W  
(high efficiency)



glare-free reflector  
longitudinally &  
transversely

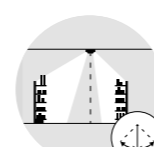

+20° up to -10°  
tiltable

Jelmoli Store  
Zurich, CH



Oasis Store Melbourne, AU –  
by Sync Design



# In the spotlight

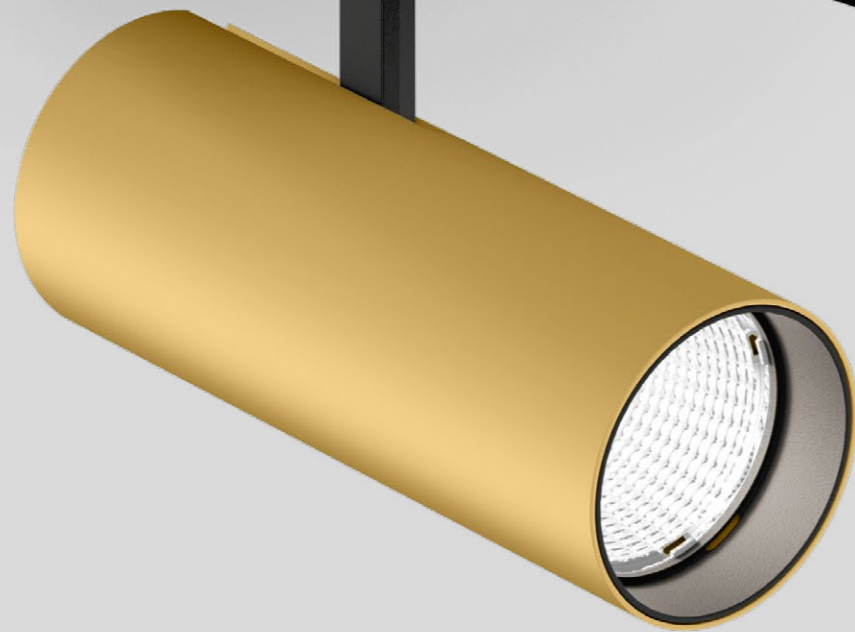

## BO intrack

**EN** Elegant and flexible – this is what characterises the BO track spotlight series. Several sizes and different beam angles offer enormous freedom in setting the scene. The Intrack versions are available as one-, two-, or three-flame spotlights. In addition, the spots can be rotated and pivoted at different angles, making BO an ideal spotlight for shops and staging areas. Different housing and light colours (2700K, 3000K, or 4000K) offer flexibility in different architectural concepts and promise very good colour rendering of up to  $CRI \geq 95$  (2-SDCM).

**ES** Belleza y flexibilidad son las características definitorias de los focos de carril electrificado de la serie BO. Sus diversos tamaños y ángulos de apertura ofrecen una gran libertad a la hora de la puesta en escena. Las variantes «intrack» de inserción en carril están disponibles como focos simples, dobles o triples. Además, los proyectores pueden girarse e inclinarse en distintos ángulos, lo que convierte a BO en una luminaria ideal para tiendas y superficies de presentación de artículos. Diferentes carcasas y temperaturas de color (2700K, 3000K o 4000K) proporcionan flexibilidad en la realización de distintos esquemas arquitectónicos y garantizan una reproducción cromática excelente de hasta  $IRC \geq 95$  (2 SDCM).

### Types

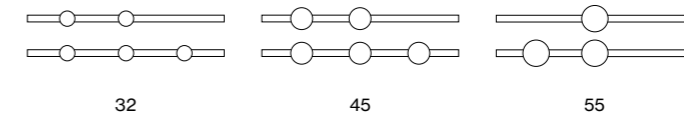

### Mounting



track

### Light distribution

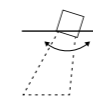

spotlight

## Matched proportions

**EN** Elegance in the right measure: All BO product family spotlights are characterised by their decorative and simple aesthetics. Thanks to their reduced design and precisely coordinated proportions, all BO models can be combined with each other.

**ES** Elegancia en su justa medida: todos los focos de la familia de productos BO se distinguen por su estética sencilla y decorativa. Gracias a su diseño minimalista y a la precisa adaptación de sus proporciones, todas las variantes de BO pueden combinarse perfectamente unas con otras.



## Colour variety

**EN** BO is available in standard white and black. For even more design freedom, additional colour options are available so that you can tailor BO to your individual project. Learn more about our colour palette at [xal.com/colours](http://xal.com/colours).

**ES** BO está disponible en los colores estándar blanco y negro. La gama adicional de colores disponibles le permite gozar de una libertad de diseño aún mayor y adaptar la luminaria BO a su proyecto concreto. Hallará más información sobre nuestra paleta de colores en [xal.com/es/servicios/colores-especiales](http://xal.com/es/servicios/colores-especiales).



[xal.com/colours](http://xal.com/colours)

## Variety

**EN** The BO Intrack versions are available as single-, double-, or triple-flame spotlights. The spotlight heads are available in three different diameters and different housing and light colours (2700 K, 3000 K, or 4000 K), offering even more flexibility for unique projects. The multi-flame version of the Inset requires only one control gear, which means that the individual spotlights are closer together. This makes these variants not only space-saving but also more cost-efficient.

**ES** Las variantes BO intrack están disponibles como focos de carril simples, dobles o triples. Los cabezales de foco en tres diámetros distintos y diferentes colores de carcasa y temperaturas de color (2700 K, 3000 K o 4000 K) ofrecen aún más flexibilidad para la realización de proyectos excepcionales. El inserto multifoco precisa de un único mecanismo de control, con lo que los distintos focos quedan colocados más cerca unos de otros. Así, estas variantes no solo ahorran espacio, sino que también son más económicas.

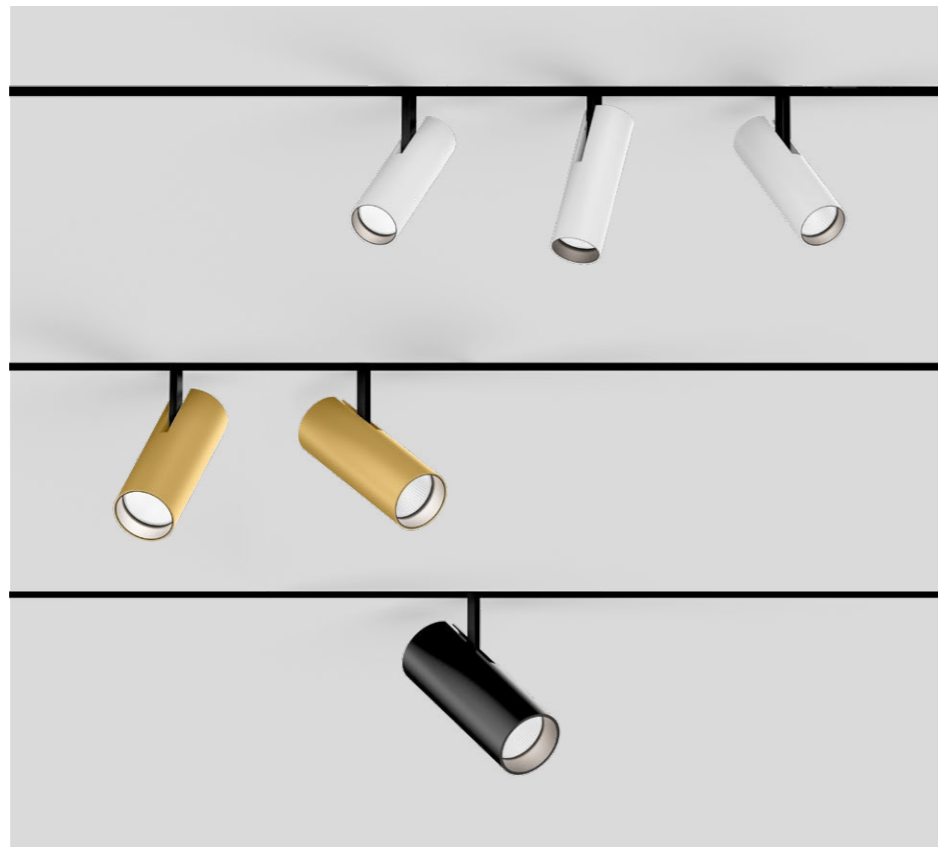

## Intrack

**EN** Flexible adjustment – easy installation: In the track version, BO combines different sizes and beam angles. Thus, ever new lighting scenarios can be implemented: from the selective presentation of goods and products to the staging of art objects and home accessories. The converter disappears elegantly into the track.

**ES** Ajuste flexible, fácil montaje: en la variante embutida en carril, BO ofrece distintos tamaños y ángulos de apertura. Esto permite realizar puestas en escena luminosas siempre nuevas, desde la presentación de artículos y productos con acentos puntuales hasta la iluminación precisa de objetos de arte y complementos de decoración. El driver desaparece elegantemente dentro del carril.

## Flexible adjustment

## Flexible adjustment

**EN** BO adapts to the requirements to ensure that objects are presented in the best possible light. The spotlight comes in different beam angles and is rotatable by at least 360°, as well as 90° tiltable.

**ES** BO se adapta a los requisitos específicos para poner en escena los objetos de la mejor forma posible. El foco está disponible con distintos ángulos de apertura, y además puede girar a 360° e inclinarse 90°.

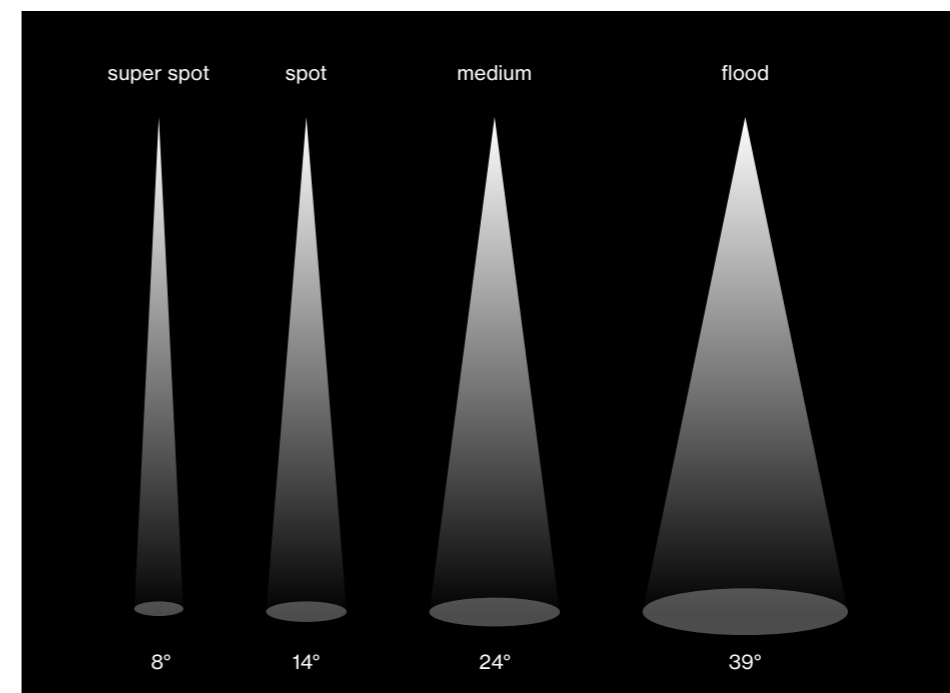





## BO 32/45/55

intrack

**EN** Track light made of die-cast aluminium; powder coated; spotlight head rotates 360° and tilts 90°; choice of single lamp, double lamps or triple lamp; converter in the adapter; with optional high quality lens system with precise radiation characteristic; or high quality, aluminium, vapour deposition coated reflector with faceted design; precise radiation characteristics with different beam angles; good glare reduction due to recessed light point plane; optical attachments as accessories; COB (Chip on Board) technology or high power LEDs - maximum efficiency; no multiple shadows; energy-eff. LEDs - very good colour rendering; adapter for toolless insertion or movement on a variety of 3-phase power tracks; adapter flush with the power track

**ES** Proyector de carril electrificado de fundición de aluminio inyectado; recubierto de polvo; cabezal de proyector giratorio de 360° y orientable 90°; disponible con flujo de luz simple, doble o triple; driver en el adaptador; opcionalmente con sistema óptico de lentes de alta calidad con precisa característica de emisión; o reflector de alta calidad vaporizado de aluminio con revestimiento de facetas esféricas; característica de emisión precisa con diferentes ángulos de emisión; buen control del deslumbramiento mediante plano de punto de luz retranqueado; los accesorios ópticos como accesorios; tecnología COB o LEDs de alta potencia - máxima eficiencia; no sombras múltiples; LED energét. efíc. - excelente reprod. crom.; adaptador para instalación sin herramientas o desplazamiento en diferentes carriles electrificados de 3 fases; adaptador enrasado con la barra conductora

### Quickinfo

2700 K, 3000 K, 4000 K  
 CRI ≥ 90, 2 SDCM  
 BO 32 up to 69lm/W  
 BO 45 up to 91lm/W  
 BO 55 up to 85lm/W  
 L80 @ 50 000 h  
 DALI-2

### Types

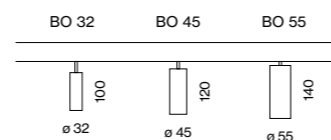

### Colours



### Light distributions

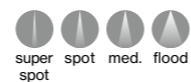

### Order options

COLOUR TEMPERATURE	
2700K	4
3000K	5
4000K	6

### CONTROL

DALI-2

### MATERIAL COLOUR

○ traffic white RAL 9016	7
● jet black RAL 9005	8
● special colours	X

### BEAM ANGLE BO 32

spot 18°	S
medium 23°	M
flood 37°	F

### BEAM ANGLE BO 45

super spot 8°	V
spot 14°	S
medium 24°	M
flood 39°	F

### BEAM ANGLE BO 55

spot 17°	S
medium 23°	M
flood 37°	F

### Options on request

#### COLOUR RENDERING INDEX

CRI ≥ 95, 2 SDCM

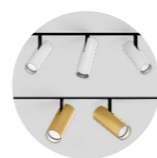

only one adapter  
with 2 or 3 lamps



360° rotatable  
90° tiltable

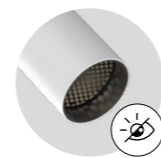

glare control via  
honeycomb louver

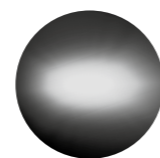

oval lens for oval  
light illumination



CRI ≥ 95  
2 SDCM

**LUMINOUS FLUX** value calculated for 3000 K, CRI ≥ 90, colour white, flood 2700 K -5%, 4000 K +7%



### BO 32 intrack

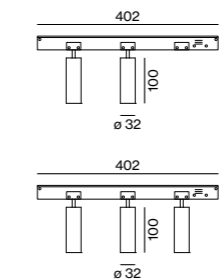

#### TRACK LIGHT

TYPE	SYS. POWER	LUMINOUS FLUX	ORDER CODE
2 lamps	20.5 W	1440 lm	180-7140::3▲▲
3 lamps	28.8 W	2020 lm	180-7150::3▲▲



### BO 45 intrack

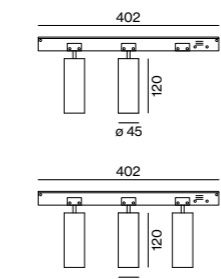

#### TRACK LIGHT

TYPE	SYS. POWER	LUMINOUS FLUX	ORDER CODE
2 lamps	14.2 W	super spot 2×320 lm	180-7240::3▲V
	30 W	spot 2×1020 lm	180-7240::3▲S
3 lamps	32 W	med., flood 2×1330 lm	180-7240::3▲▲
	45 W	spot 3×1020 lm	180-7250::3▲S
	42 W	med., flood 3×1180 lm	180-7250::3▲▲



### BO 55 intrack

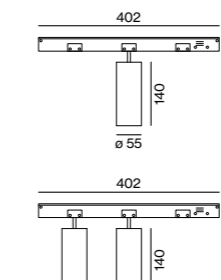

#### TRACK LIGHT

TYPE	SYS. POWER	LUMINOUS FLUX	ORDER CODE
1 lamp	24.8 W	1940 lm	180-7330::3▲▲
2 lamps	43 W	3460 lm	180-7340::3▲▲

### Optical accessories

#### HONEYCOMB LOUVER

TYPE	Ø H (mm)	ORDER CODE
BO 32	30-3	007-1965168
BO 45	42-3	007-1965188
BO 55	50-3	007-1965598

#### OVAL LENS

TYPE	Ø H (mm)	ORDER CODE
BO 32	30-3	007-1965860
BO 45	42-3	007-1965880
BO 55	50-3	007-1965890

#### SOFT LENS

TYPE	Ø H (mm)	ORDER CODE
BO 32	30-3	007-1965960
BO 45	42-3	007-1965980
BO 55	50-3	007-1965990

**Euroshop**  
Dusseldorf, DE –  
by blocher partners





**Oberpollinger | The KaDeWe Group**  
Munich, DE – by Licht Kunst Licht AG  
including lighting design



# Universal expert

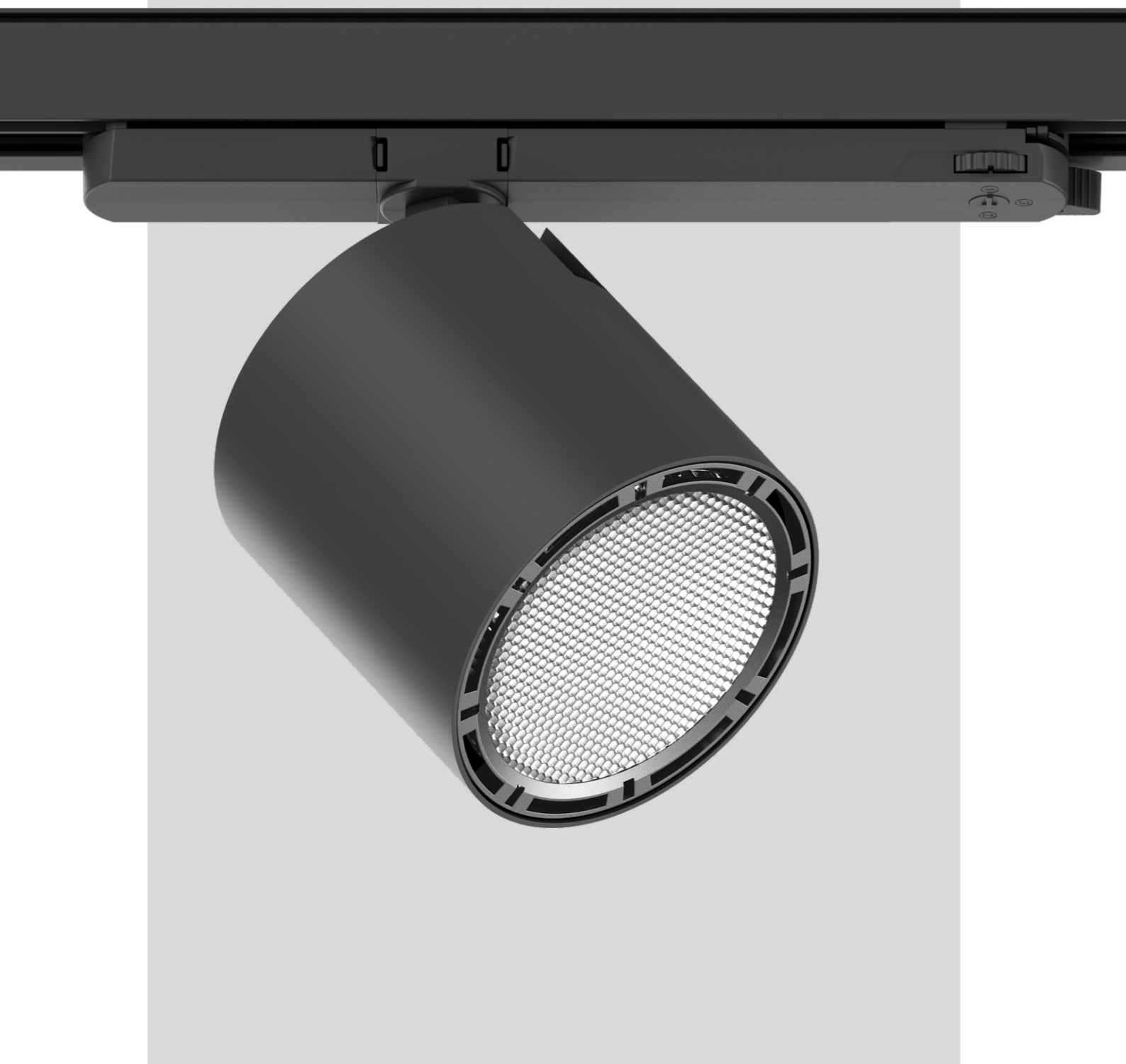

## VARO

**EN** As a track-mounted spotlight, VARO focuses on the essentials and can be used universally. It is available in two different sizes and, thanks to its 355° rotation and 90° swivelling capability, is extremely flexible in use. This flexibility is supported by the fact that the spotlights can be inserted and moved along the track without tools. It is ideal for use in shops whose interior design is continually evolving. In addition, the powerful VARO provides maximum efficiency for the illumination of products. The high-quality reflector from VARO ensures a particularly precise beam characteristic at different angles, all with an excellent colour rendering up to  $CRI \geq 90$ . Depending on the desired spatial effect, you can choose between the 3000 K and 4000 K light colours.

**ES** VARO es un foco de carril electrificado de uso universal que se centra en lo esencial. Está disponible en dos tamaños distintos y ofrece un uso altamente dinámico, gracias a su capacidad de giro a 355° e inclinación a 90°. Esta flexibilidad se acentúa por su colocación sin necesidad de herramienta y el sencillo desplazamiento de los focos en el carril electrificado, siendo el elemento perfecto para tiendas sujetas a cambios de distribución constantes. Además, el potente VARO ofrece la máxima eficacia en la iluminación de artículos. El magnífico reflector de VARO garantiza una proyección altamente precisa en ángulos distintos, a lo que se le añade una sólida reproducción cromática de hasta  $IRC \geq 90$ . En función del efecto deseado, es posible elegir entre temperaturas de color de 3000 K y 4000 K.

### Types



80

110

### Mounting



track

### Light distribution

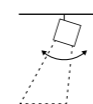

spotlight



## VARO 80 S

track

**EN** Track light made of die-cast aluminium; surface powder coated; spotlight head 355° rotatable and 90° tiltable; integrated converter in the plastic adapter; high quality reflector with spherical facet finish; precise radiation characteristics with different beam angles; installed and exchanged without tools; optical attachments as accessories; optical attachments can be combined; COB (Chip on Board) technology for maximum efficiency; variants with > 120 lm/W available; no multiple shadows; energy-efficient LEDs with very good colour rendering; adapter for toolless insertion or movement on a variety of 3-phase power tracks

**ES** Proyector de carril electrificado de fundición de aluminio inyectado; superficie con recubrimiento de pintura en polvo; proyector giratorio 355° y orientable 90°; convertidor integrado en adaptador de plástico; reflector alta calidad con óptica de bisel esférica; característica de emisión precisa con diferentes ángulos de emisión; intercambiable sin herramienta; los accesorios ópticos como accesorios; accesorios ópticos combinables entre sí; con tecnología COB para proporcionar una máxima eficiencia; variantes disponibles con > 120 lm/W; no proporciona sombras múltiples; LEDs de alta eficiencia que proporcionan una alta reproducción cromática; adaptador para instalación sin herramientas o desplazamiento en diferentes carriles electrificados de 3 fases

### Quickinfo

3000K, 4000K  
CRI ≥ 90, 3 SDCM  
up to 129lm/W  
L95/50 000h  
non DIM, DALI-2

### Type

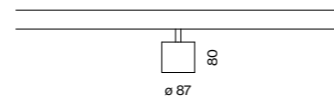

### Colours



### Light distributions



### Order options

COLOUR TEMPERATURE	
3000K	0
4000K	1

CONTROL	
non DIM	1
DALI-2	3

MATERIAL COLOUR	
○ traffic white RAL 9016	7
● jet black RAL 9005	8

BEAM ANGLE	
spot 17°	S
medium 28°	M
flood 38°	F

### Options on request

COLOUR RENDERING INDEX
CRI ≥ 80

CONTROL
Casambi
DALI-2 (high efficiency)

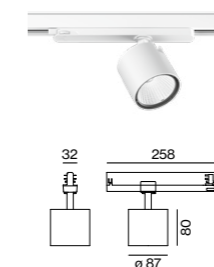

### VARO 80 S track



#### TRACK LIGHT

SYSTEM POWER	LUMINOUS FLUX	ORDER CODE
28.5W	2600lm	180-6420::1▲▲
45W	3610lm	180-6421::1▲▲

#### HIGH EFFICIENCY

SYSTEM POWER	LUMINOUS FLUX	ORDER CODE
21.3W	2730lm	180-6422::1▲▲
25.4W	3160lm	180-6423::1▲▲

### Optical accessories

#### LENSES AND HONEYCOUMB LOUVER

TYPE	Ø-H (mm)	ORDER CODE
linear prismatic lens	75-9	080-6402110P
honeycomb louver	75-9	080-6401118



#### SNOOT

TYPE	Ø-H (mm)	ORDER CODE
short	66-23	080-6403118
medium	66-38	080-6403218
angle	66-38	080-6403318



possibility to combine different optical accessories (max. 2 pieces)



up to 129lm/W  
(high efficiency)



355° rotatable  
90° tiltable

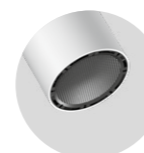

optical  
accessories



combine 2 optical  
accessories

**LUMINOUS FLUX** value calculated for  
4000K, CRI ≥ 90, colour white, flood  
3000K -7%

s.Oliver Store Munich, DE –  
by Kitzig Interior Design GmbH  
including lighting design





## VARO 110 S

track

**EN** Track light made of die-cast aluminium; surface powder coated; spotlight head 355° rotatable and 90° tiltable; integrated converter in the plastic adapter; high quality reflector with spherical facet finish; precise radiation characteristics with different beam angles; installed and exchanged without tools; optical attachments as accessories; optical attachments can be combined; COB (Chip on Board) technology for maximum efficiency; variants with > 120 lm/W available; no multiple shadows; energy-efficient LEDs with very good colour rendering; adapter for toolless insertion or movement on a variety of 3-phase power tracks

**ES** Proyector de carril electrificado de fundición de aluminio inyectado; superficie con recubrimiento de pintura en polvo; proyector giratorio 355° y orientable 90°; convertidor integrado en adaptador de plástico; reflector alta calidad con óptica de bisel esférica; característica de emisión precisa con diferentes ángulos de emisión; intercambiable sin herramienta; los accesorios ópticos como accesorios; accesorios ópticos combinables entre sí; con tecnología COB para proporcionar una máxima eficiencia; variantes disponibles con > 120 lm/W; no proporciona sombras múltiples; LEDs de alta eficiencia que proporcionan una alta reproducción cromática; adaptador para instalación sin herramientas o desplazamiento en diferentes carriles electrificados de 3 fases

### Quickinfo

3000K, 4000K  
CRI ≥ 90, 3 SDCM  
up to 132lm/W  
L95/50 000h  
non DIM, DALI-2

### Type

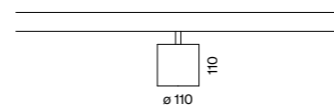

### Colours



### Light distributions



### Order options

COLOUR TEMPERATURE	
3000K	0
4000K	1

CONTROL	
non DIM	1
DALI-2	3

MATERIAL COLOUR	
○ traffic white RAL 9016	7
● jet black RAL 9005	8

BEAM ANGLE	
spot 17°	S
medium 28°	M
flood 38°	F
wide flood 65°	W

### Options on request

LUMINOUS FLUX
> 5000lm

CONTROL
Casambi
DALI-2 (high efficiency)

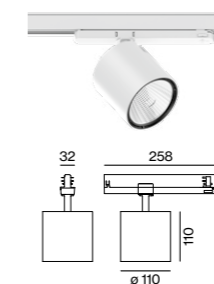

### VARO 110 S track



#### TRACK LIGHT

SYSTEM POWER	LUMINOUS FLUX	ORDER CODE
29.6W	3370lm	180-6520::1▲▲
39W	4300lm	180-6521::1▲▲

#### HIGH EFFICIENCY

SYSTEM POWER	LUMINOUS FLUX	ORDER CODE
25.7W	3400lm	180-6530::1▲▲
36W	4520lm	180-6531::1▲▲

### Optical accessories

#### LENSES AND HONEYCOUMB LOUVER

TYPE	Ø H (mm)	ORDER CODE
oval lens	106-9	080-6502210
wide flood lens	106-9	080-6502110W
honeycomb louver	106-9	080-6501118

#### SNOOT

TYPE	Ø H (mm)	ORDER CODE
short	97-23	080-6503118
medium	97-38	080-6503218
angle	97-38	080-6503318

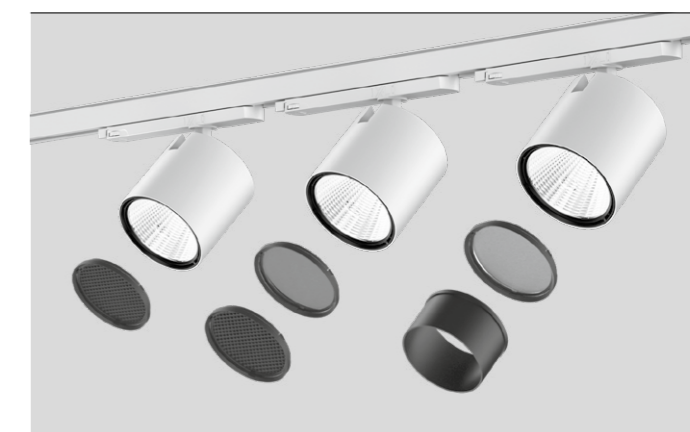

possibility to combine different optical accessories (max. 2 pieces)



up to 132lm/W  
(high efficiency)



355° rotatable  
90° tiltable

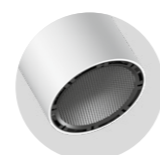

optical  
accessories



combine 2 optical  
accessories

**LUMINOUS FLUX** value calculated for 4000K, CRI ≥ 90, colour white, flood 3000K -7%

**Kastner & Öhler, Kaufhaus Tyrol**  
Innsbruck, AT – by DIOMA AG /  
WHIR3 / K&Ö Bauabteilung  
with lighting design by  
VEDDER.LICHTMANAGEMENT





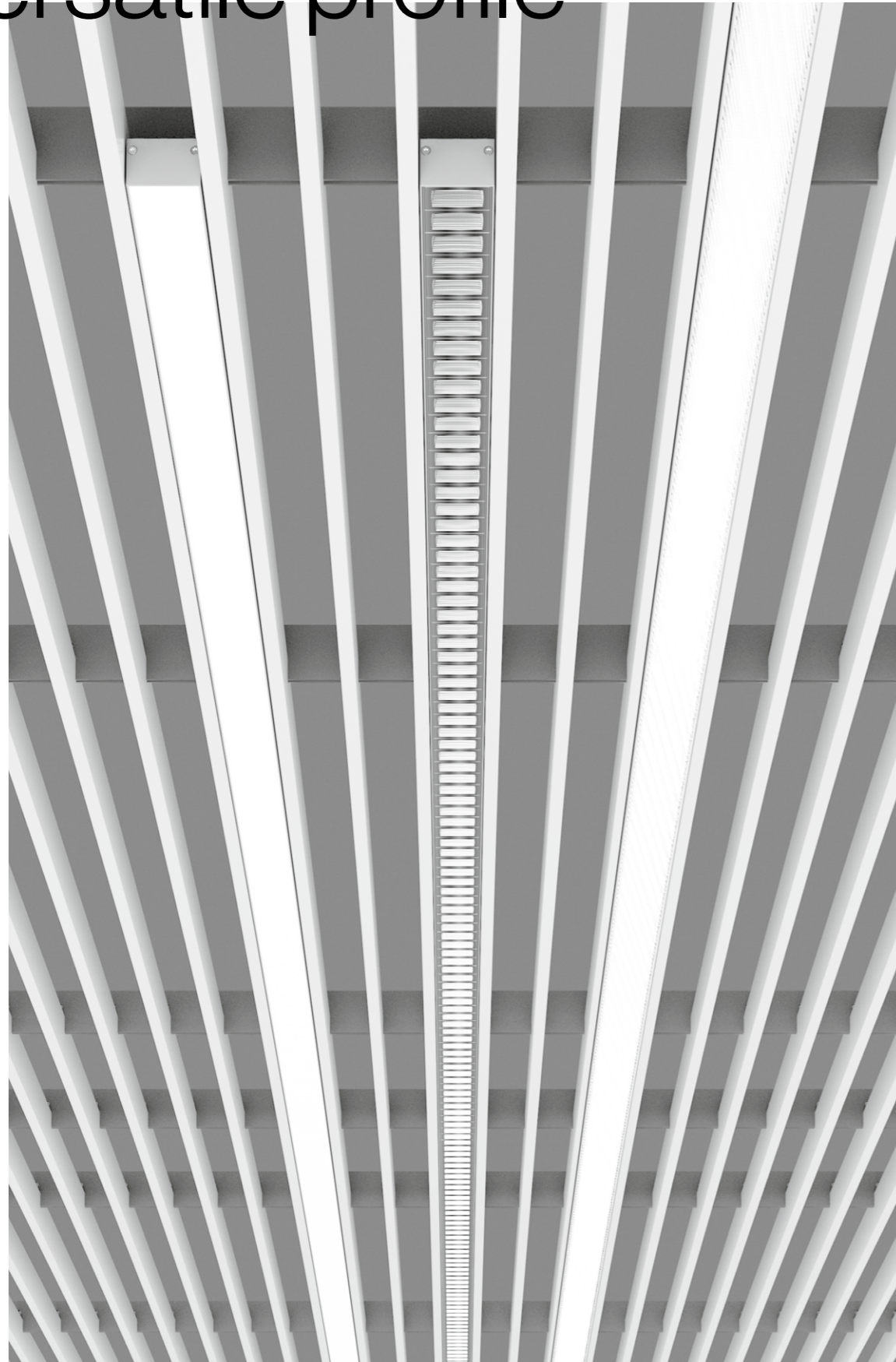

# Versatile profile



## MILA system

**EN** The MILA system luminaire was specially designed for use with slat ceilings and blends seamlessly into the respective room concept in entrance halls and office buildings. In meeting rooms and offices, the luminaire creates an ideal, screen-appropriate work light thanks to the optional addition of reflectors. In the opal cover variant, MILA is suitable for homogeneous room illumination; a reduced glare value is achieved with the optional microprismatic cover. For continuous lighting systems, the flexible Continuous Cover is the best choice. By adding special sensors, the MILA system luminaire becomes a smart lighting system. The sensors can be freely placed in the slatted ceiling and quickly integrated at a later stage. The collected room utilisation data helps to save energy over the long term.

**ES** La luminaria modular MILA ha sido concebida especialmente para el uso en falsos techos de lamas, y se integra a la perfección en cualquier esquema arquitectónico de vestíbulos y edificios de oficinas. En oficinas y salas de reuniones, la luminaria proporciona una luz de trabajo ideal apta para el uso de pantallas de visualización gracias a la ampliación opcional con reflectores. En la variante con difusor opal, MILA ofrece una iluminación general homogénea, y con el difusor microprismático opcional se consigue un índice de deslumbramiento reducido. El difusor flexible Continuous es la mejor elección para sistemas de luz lineales. Mediante la ampliación con sensores especiales, la luminaria modular MILA se convierte en un sistema de iluminación inteligente. Los sensores pueden colocarse libremente en el techo de lamas e incorporarse rápidamente con posterioridad. Los datos sobre el uso de las salas captados por ellos ayudan a ahorrar energía de forma duradera.

<b>Type</b>	
	38
<b>Mounting</b>	
	ceiling
<b>Configuration</b>	
	linear
<b>Light distributions</b>	
	opal    micro-prismatic    reflector (UGR ≤ 19)    direct



## Advanced sensor technology

**EN** By adding special sensors, the MILA system luminaire becomes a smart lighting system. The sensors can be placed freely and flexibly in the slatted ceiling, and can also be integrated quickly and easily at a later stage. With the ESSENTIAL sensor, the lighting dynamically adapts to the ambient brightness and room activity. In addition, the SENSE sensor measures values for temperature, air quality, humidity, and noise level. These data not only provide important insights into the ambient conditions, but also support energy savings over the long term.

**ES** Mediante la ampliación con sensores especiales, la luminaria modular MILA se convierte en un sistema de iluminación inteligente. Los sensores pueden colocarse libremente en el techo de lamas según las necesidades y también incorporarse de un modo rápido y sencillo con posterioridad. Con el sensor ESSENTIAL es posible adaptar la iluminación dinámicamente a la luminosidad del entorno y a la actividad en la sala. Como complemento, el sensor SENSE mide valores relacionados con la temperatura, la calidad y humedad del aire y el nivel de ruido. Esos datos no solo ofrecen información importante sobre las condiciones ambientales, sino también fomentan el ahorro energético de forma duradera.

## Continuous Cover

**EN** Both the opal and the microprismatic cover are available as continuous versions for the MILA system luminaires. This results in remarkable flexibility, as the length of the cover can be adapted exactly to the system. During installation, the Continuous Cover is simply integrated into the profile, avoiding interfering joints, and creating a pleasantly continuous lighting system.

**ES** Tanto el difusor opal como el microprismático están disponibles en un modelo «Continuous» para las luminarias modulares MILA. Esto ofrece una gran flexibilidad, ya que la longitud del difusor puede adaptarse al sistema de iluminación con exactitud. A la hora del montaje, el difusor Continuous se incorpora fácilmente en el perfil, lo que evita la formación de juntas molestas y permite obtener un magnífico sistema de alumbrado continuo.

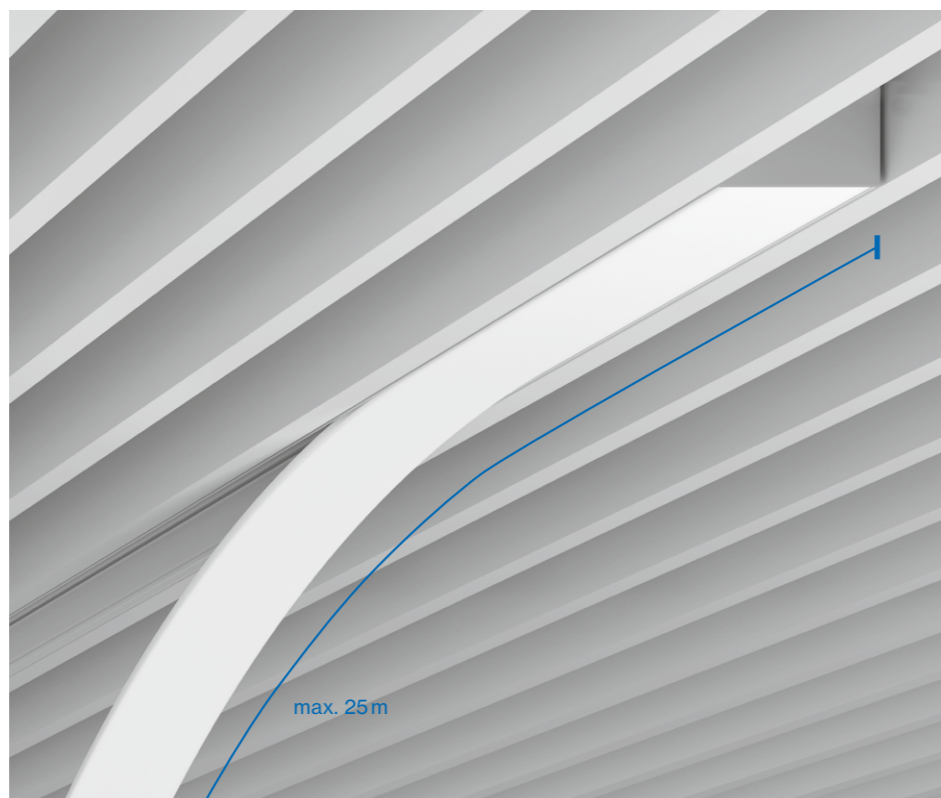

## Inset variety

**EN** Whether workplace lighting or general building areas – the MILA system luminaire can be adapted depending on the area of application. For screen-appropriate task lighting, the  $UGR \leq 19$  glare-reduced reflectors are the right choice. The optionally available opal cover is suitable for homogeneous ambient illumination. The microprismatics with reduced glare value are ideal for pleasantly illuminating entrance areas and corridors.

**ES** Ya se trate de la iluminación de puestos de trabajo o de zonas generales de edificios, la luminaria modular MILA puede modificarse en función del ámbito de uso. En el caso de una iluminación de puestos de trabajo apta para pantallas de visualización, el uso de reflectores antideslumbrantes con  $UGR \leq 19$  constituye la elección correcta. El difusor opal disponible opcionalmente es adecuado para un alumbrado general homogéneo. La variante microprismática con un índice de deslumbramiento reducido es perfecta para iluminar zonas de entrada y pasillos de forma agradable.



## Mounting

**EN** MILA can provide the right lighting in any room via sturdy mounting brackets that are hooked into the slatted ceiling. The brackets can be flexibly moved along the luminaire and can thus be positioned as required, or subsequently adjusted. Converters with wiring-through function facilitate electrical installation, as wiring can thus be carried out easily and quickly from one luminaire to another. In addition, the free movement of the converter allows a flexible response to ceiling conditions.

**ES** Colocada sobre abrazaderas de fijación resistentes que se enganchan al techo de lamas, MILA ofrece una iluminación adecuada en cualquier sala. Las abrazaderas pueden desplazarse a placer a lo largo de la luminaria para reposicionarla o bien para adaptarla posteriormente en función de las necesidades. El driver con función «wiring-through» facilita la instalación eléctrica, ya que permite que el cableado pueda pasarse de luminaria a luminaria de un modo rápido y sencillo. Además, el libre desplazamiento del driver permite la adaptación rápida del sistema a las condiciones del techo.

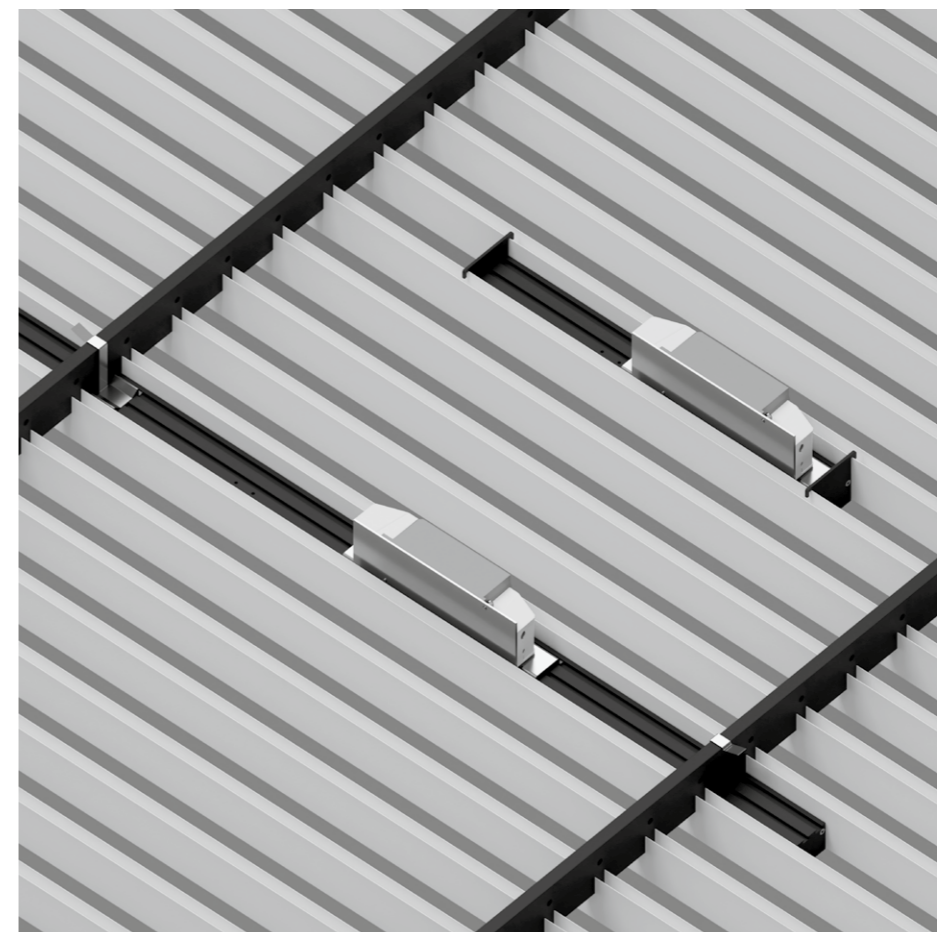

**HAUFE**  
DECKENSYSTEME

## MILA system

ceiling

EN Luminaire housing from extruded aluminium profile, angular design; designed for continuous lighting systems; suitable for installation in the HAUFE louvre ceiling system; surface powder coated; HPO (High Performance Opal) cover or microprismatic cover in the length of the light inset or continuous cover (both separately available); optional high gloss reflector with faceted design; converter flexible positionable on the luminaire profile; converter suitable for through-wiring; energy-efficient LEDs with very good colour rendering; optionally sensor inset (ESSENTIAL or SENSE) available as accessory

ES Cuerpo de perfil de aluminio con diseño angular; diseñado para la creación de sistemas continuos; apta para integr. en sistema de techo de lamas HAUFE; superficie con recubrimiento de pintura en polvo; difusor HPO (High Performance Opal) o microprismático en la longitud del inserto luminoso o difusor continuo (deben encargarse por separado); opcional reflector de alto brillo con óptica facetada; driver de libre posicionamiento en el perfil de la luminaria; driver apto para cableado continuo; LEDs de alta eficiencia que proporcionan una alta reproducción cromática; inserto de sensor (ESSENTIAL o SENSE) disponible como accesorio

### Quickinfo

3000K, 4000K  
CRI ≥ 90, 3 SDCM  
UGR ≤ 19 / 65° ≤ 1500 cd/m<sup>2</sup>  
up to 115 lm/W  
up to 103 lm/m  
L90 @ 50 000 h  
DALI-2  
opal, microprismatic  
reflector (UGR ≤ 19)

### Types

opal / microprismatic

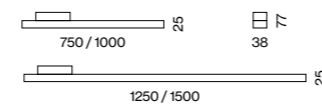

reflector

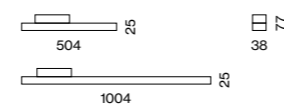

### Colours



### Light distribution



direct



DiiA® standards  
251, 252, 253



suitable for  
HAUFE ceilings

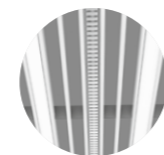

continuous  
lighting system



sensor for  
single mounting



DIN EN 12464-1  
UGR ≤ 19



up to 115 lm/W  
(high efficiency)

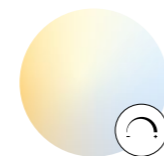

tunable white  
2700-6500 K

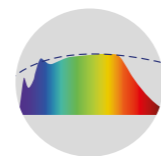

CRI ≥ 98  
XPECTRUM

### Order options

<b>COLOUR TEMPERATURE</b>	
3000K	0
4000K	1

### CONTROL

DALI-2

### MATERIAL COLOUR

<input type="radio"/> traffic white RAL 9016	7
<input checked="" type="radio"/> jet black RAL 9005	8

### LIGHT OPTIC COVER

opal	H
microprismatic	Z
reflector (UGR ≤ 19)	

### Options on request

**COLOUR RENDERING INDEX**  
CRI ≥ 98 XPECTRUM

### COLOUR TEMPERATURE

tunable white 2700-6500 K

### SLAT CEILING SOLUTION

Hunter Douglas  
Interalu SAPPceiling

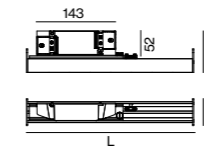

### MILA opal/microprismatic ceiling



#### SYSTEM LUMINAIRE

SYSTEM POWER	L (mm)	ORDER CODE
15.8W	750	045-9022::3
21W	1000	045-9023::3
25W	1250	045-9024::3
31W	1500	045-9025::3

#### COVER

TYPE	L (mm)	ORDER CODE
linear	750	006-4107510
linear	1000	006-4110010
linear	1250	006-4112510
linear	1500	006-4115010
continuous linear	6000	006-2106010
continuous linear	25000	006-2125010

LIGHT OPTIC COVER	COLOUR TEMPERATURE	SYSTEM POWER	DELIVERED LUMENS	EFFICACY
opal	3000K	21W/m	2200 lm/m	105 lm/W
	4000K		2420 lm/m	115 lm/W
microprismatic	3000K	21W/m	2090 lm/m	100 lm/W
	4000K		2300 lm/m	110 lm/W

### MILA reflector ceiling



#### SYSTEM LUMINAIRE

SYSTEM POWER	L (mm)	ORDER CODE
11W	504	045-9121::3
22W	1004	045-9123::3

LIGHT OPTIC COVER	COLOUR TEMPERATURE	SYSTEM POWER	DELIVERED LUMENS	EFFICACY
reflector (UGR ≤ 19)	3000K	22 W/m	2790 lm/m	126 lm/W
	4000K		2950 lm/m	133 lm/W

### Accessories

#### END CAPS

TYPE	ORDER CODE
end caps (pair)	045-909001

#### LINEAR CONNECTOR

TYPE	ORDER CODE
mechanical linear connector	045-9091010

#### SENSOR DALI-2

TYPE	ORDER CODE
ESSENTIAL (brightness & presence)	045-909601
SENSE (brightness, presence, temperature, sound pressure, humidity, CO <sub>2</sub> )	045-909602

**Viega GmbH** Attersee, AT –  
by ATP Planungs- und Beteiligungs AG with  
lighting design by Andreas Haidegger

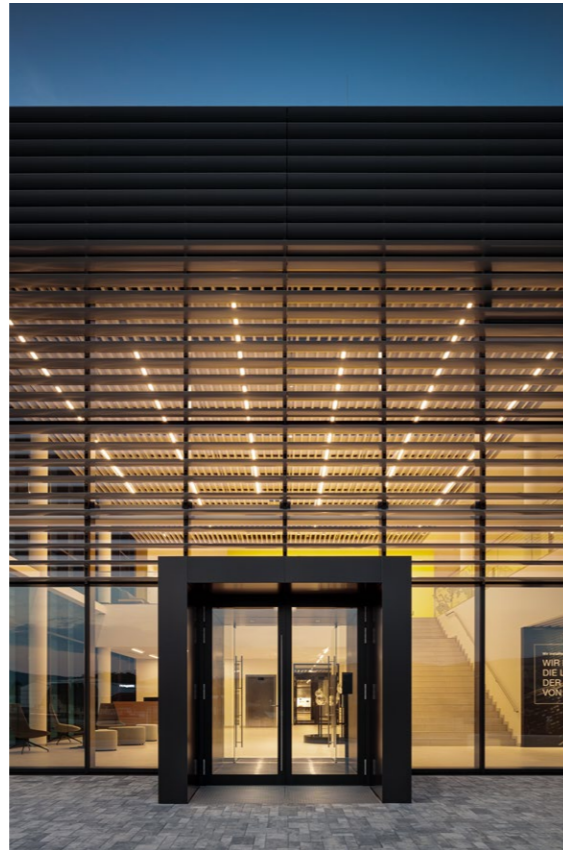



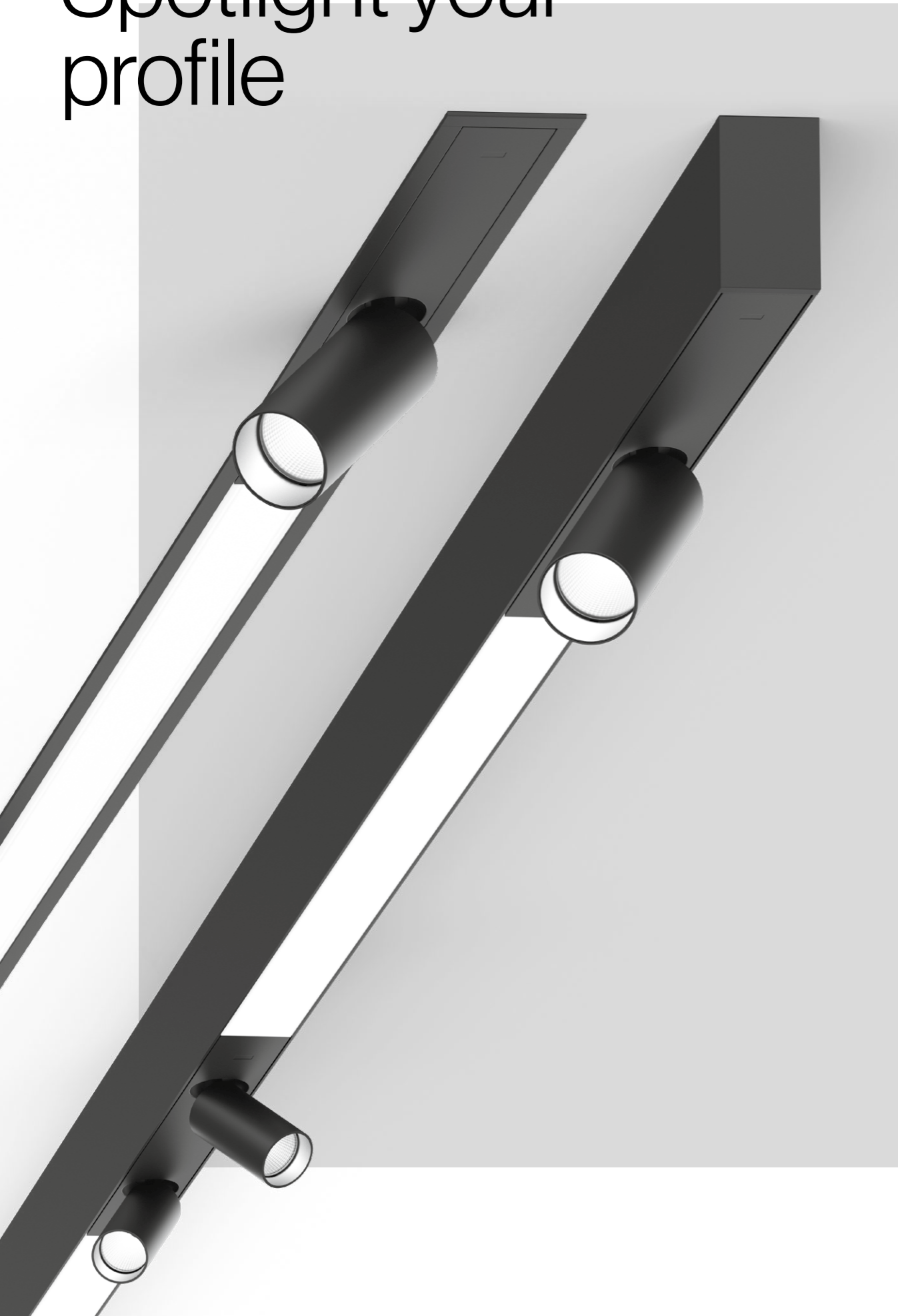







# Spotlight your profile



## FRAME/MINO 40 system

**EN** The FRAME 40 and MINO 40 system luminaires set no limits on profile-based ambient lighting. Thanks to special Flex Insets, the system luminaires can be shortened on-site and thus adapted to all conditions. Corner connectors create continuous lighting systems. For particularly uniform room illumination, the profile luminaires are fitted with an opal cover. In addition, spotlight insets can be selected for elegant accent lighting in corridors or entrance areas. Select a light colour of 3000K, 4000K, or optionally Tunable White, and a colour rendering of up to  $\text{CRI} \geq 98$  (XPECTRUM).

**ES** Las luminarias modulares FRAME 40 y MINO 40 satisfacen cualquier necesidad en el área del alumbrado general con sistemas de perfiles. Gracias a sus insertos Flex especiales, estas luminarias pueden acortarse en el propio lugar de instalación y adaptarse a cualquier circunstancia. Los conectores de esquinas hacen posible la obtención de sistemas de iluminación continuos. Estas luminarias se han dotado de un difusor opal para un alumbrado especialmente uniforme de las salas. También es posible elegir insertos de foco para una acentuación elegante en pasillos o zonas de entrada. En el área de la temperatura de color puede elegirse entre 3000K, 4000K y, opcionalmente, Tunable White. Por su parte, la reproducción cromática alcanza un índice  $\text{IRC} \geq 98$  (XPECTRUM).

<b>Type</b>	
	40
<b>Mountings</b>	  
	with trim recessed    surface    suspended
<b>Configurations</b>	 
	linear    corner
<b>Light distributions</b>	   
	opal    direct    spotlight    wallwasher floor

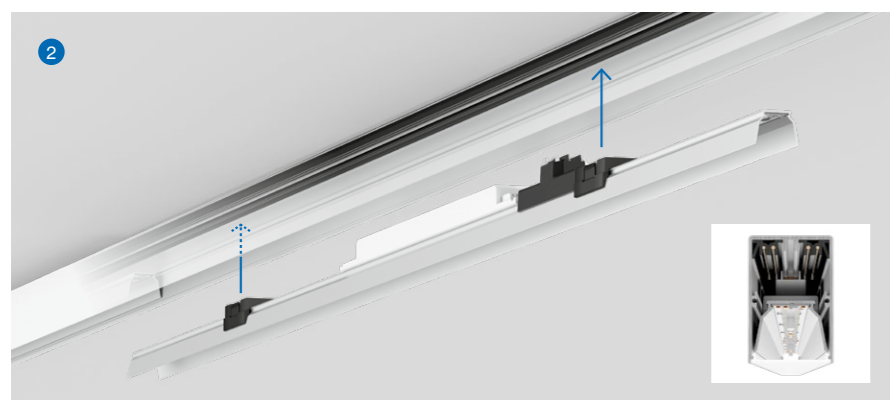
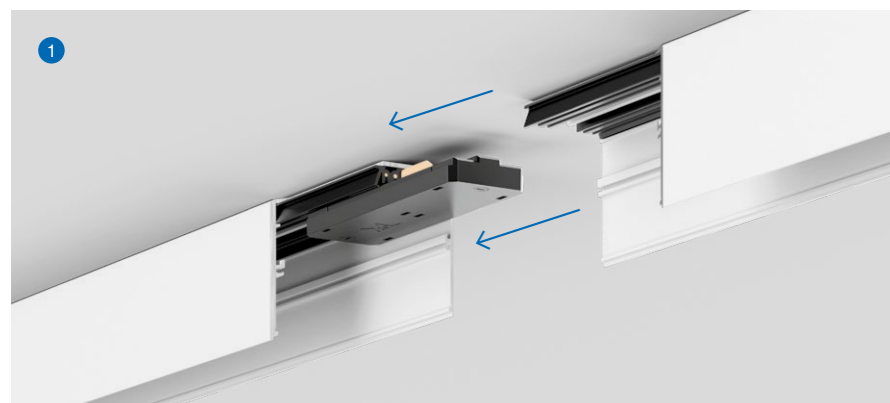

## Easy Mounting

**EN** MINO 40 / FRAME 40 is based on a profile with an integrated track, which makes only one power feed point necessary.

(1) Two profiles are connected to each other with mechanical and electrical connectors.

(2) The patent-pending snap-in system allows the inset to be quickly and easily mounted in the profile. This simplifies the installation and maintenance of the system.

(3) The flexible Continuous Cover can be adjusted exactly to the length of the system and simply installed in the profile during mounting. This creates a continuous lighting system without disturbing joints.

**ES** MINO 40 y FRAME 40 constan de un perfil con carril eléctrico incorporado, por lo que solo se necesita disponer de una toma de alimentación.

(1) Un conector mecánico y eléctrico insertable permite conectar dos perfiles entre sí fácilmente.

(2) Con el mecanismo Snap-In (en espera de patente), el inserto puede introducirse en el perfil de una forma rápida y sencilla. Esto simplifica el montaje y el mantenimiento del sistema.

(3) El flexible difusor Continuous puede adaptarse con exactitud a la longitud del sistema e incorporarse en el perfil fácilmente durante el montaje. Esto permite obtener un sistema de iluminación continuo sin juntas molestas.

## Full-spectrum LED

**EN** XAL's new XPECTRUM LEDs deliver healthy, biologically effective light. The reduced blue light component and increased cyan values reduce the blue light hazard for the eye to daylight-equivalent levels. The resulting non-visual, so-called melanopic light effect, improves concentration and increases sleep quality. The excellent colour rendering of IES TM 30-15  $R_f = 98$  and  $R_g = 101$  further helps visual comfort.

**ES** El nuevo LED XPECTRUM de XAL ofrece una luz saludable con efectos biológicos. La menor proporción de luz azul y el aumento de los valores de cian minimizan el riesgo de la incidencia de luz azul en el ojo, manteniéndola a un nivel similar al presente en la luz natural. El efecto no visible resultante, denominado efecto melanópico, fomenta la concentración y mejora la calidad del sueño. Además, su excelente reproducción cromática –con índices  $R_f = 98$  y  $R_g = 101$  según la norma IES TM 30-15– garantiza una mayor comodidad visual.

XPECTRUM LED

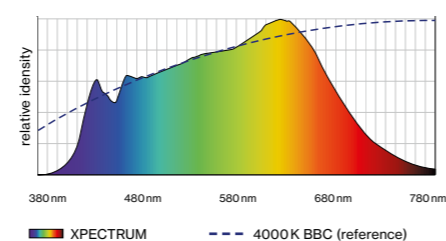

Commercially available LED 4000 K

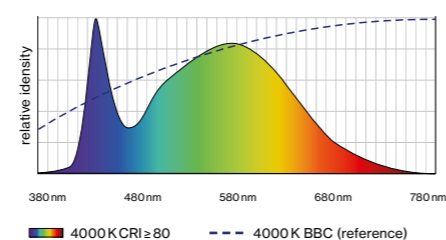

## Precise planning with flex insets

**EN** Your lighting system can be easily adapted to existing room dimensions. You can determine bespoke lengths for MINO 40 / FRAME 40. The special flex insets are precisely and flexibly adapted on-site during assembly. Boards are simply cut off at prefabricated break-points. These are positioned at 62.5 mm or 125 mm, depending on the length of the profile. This gives you a free hand and minimal restrictions in the lighting design.

**ES** Su sistema de iluminación puede adaptarse fácilmente a las dimensiones espaciales existentes. Para MINO 40 / FRAME 40 puede elegir las longitudes que prefiera. Los insertos especiales Flex se adaptan durante el montaje con exactitud y flexibilidad: las pletinas se separan fácilmente por áreas de rotura prefabricadas. Están se hallan a 62,5 mm o a 125 mm en función de la longitud del perfil. Esto le ofrece una total libertad y elimina las limitaciones en la planificación luminotécnica.

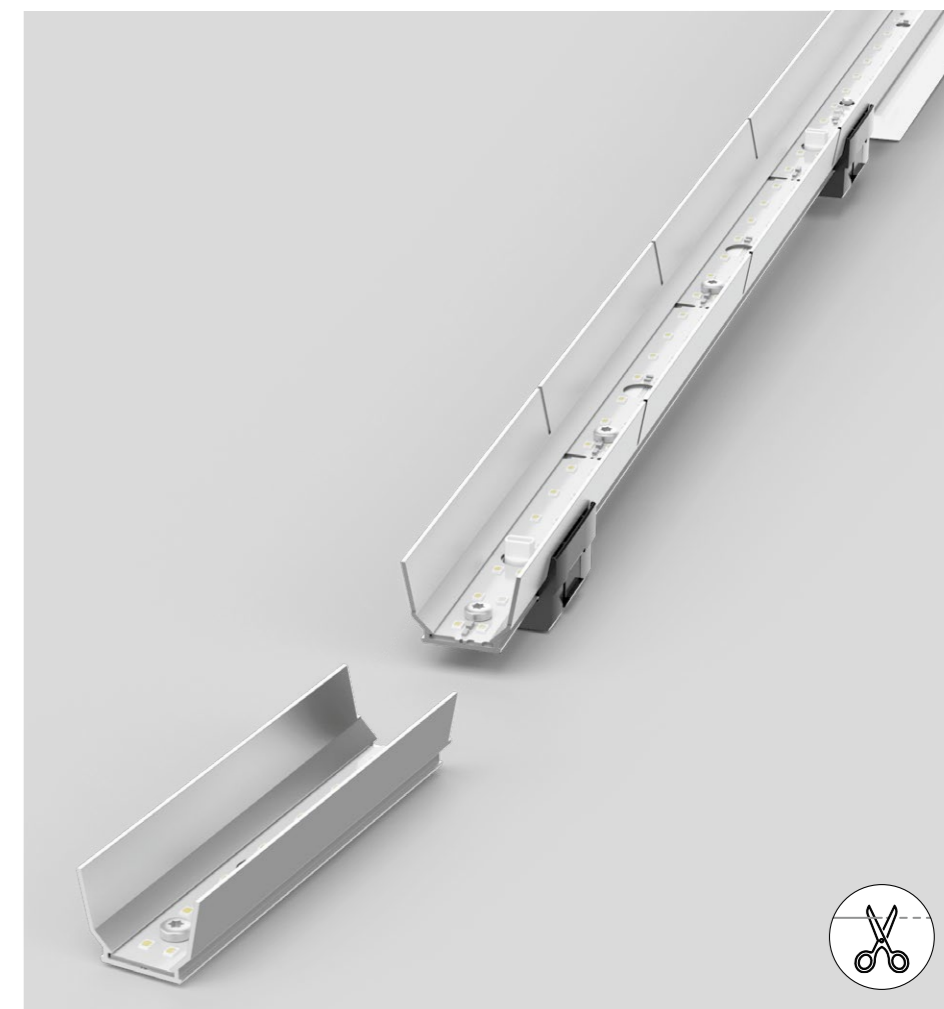

## Spot Insets

**EN** Elegant room accentuation and reduced design: with the new Spot Insets, the system luminaires become convertible luminaires for stylish wall, floor, and ceiling accentuation. In addition, the Wallwasher Floor light inset is perfect for uniform illumination of a blackboard in the classroom, or a corridor. The tool-free installation of the insets is completed in one move, the spotlights can be simply unlocked and snapped into place.

**ES** Acentuación elegante de la sala con un diseño minimalista: los nuevos insertos de foco transforman los sistemas de perfiles en luminarias convertibles para una acentuación estilizada de paredes, suelos o techos. Además, el inserto bañador de pared-suelo es ideal para una iluminación uniforme de la pizarra en aulas de enseñanza o de pasillos. El montaje del inserto sin necesidad de herramienta es muy sencillo, y los focos pueden ponerse y quitarse con total facilidad.

## FRAME 40 system

recessed with trim

<sup>EN</sup> Luminaire housing made of extruded aluminium; recessed luminaire with trim; designed for continuous lighting systems; suitable for ceiling thickness of 8-25 mm; surface powder coated; luminaire profile for mounting available in advance; remaining luminaire components mounted without tools; HPO (High Performance Opal) cover in the length of the light inset or continuous cover (both separately available); pre-assembled power rail for power supply in luminaire profile; voltage tap of the light inset on the power rail; light inset consisting of highly reflective coated extruded profile for improved thermal management; energy-efficient LEDs with very good colour rendering; optionally spotlight modules can be installed

<sup>ES</sup> Cuerpo de lámpara de perfil extrusionado de aluminio; luminaria empotrable con marco; diseñado para la creación de sistemas continuos; apropiada para grosores de techo entre 8-25 mm; superficie con recubrimiento de pintura en polvo; perfil disponible para pre-montaje; resto de componentes luminosos montables sin herramienta; difusor HPO (High Performance Opal) en la longitud del inserto luminoso o difusor continuo (ambos deben encargarse por separado); carril eléctrico premont. para suministro de corr. en perfil de lumin.; toma de corr. para inserto lumin. en carril eléctrico; elemento de luz formado por perfil extruido con acabado altamente reflectante para una gestión térmica mejorada; LEDs de alta eficiencia que proporcionan una alta reproducción cromática; compatible con insertos de foco

### Quickinfo

3000K, 4000K  
CRI ≥ 90, 3 SDCM  
up to 2420lm/m  
up to 123lm/W  
L85 @ 50000h  
DALI-2

### Types

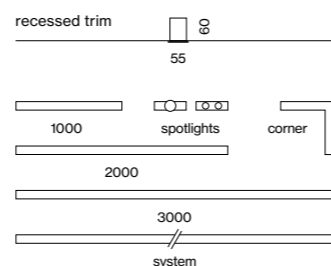

### Colours



### Light distributions

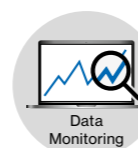

Data Monitoring  
DiiA® standards  
251, 252, 253

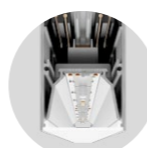

snap-in system  
(patent pending)



spotlight  
insets (p.130)



breakable  
flex insets

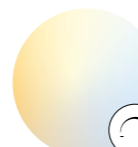

tunable white  
2700–6500K

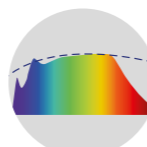

CRI ≥ 98  
XPECTRUM

### Order options

LED TYPE	
mid lumen	1
high lumen	2

COLOUR TEMPERATURE	
3000K	0
4000K	1

CONTROL	
DALI-2	

MATERIAL COLOUR	
○ traffic white RAL 9016	7
● white aluminium RAL 9006	G
● jet black RAL 9005	8

LENGTH	
1000 mm	1
2000 mm	2
3000 mm	3

LIGHT OPTIC COVER	
opal high performance	

### Options on request

COLOUR RENDERING INDEX	
CRI ≥ 98 XPECTRUM	

COLOUR TEMPERATURE	
tunable white 2700–6500K	

LIGHT OPTIC COVER	
microprismatic	

### FRAME 40 trim

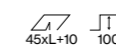

INSTALLATION CHANNEL	L (mm)	ORDER CODE
channel	1000	042-700201
channel	2000	042-700401
channel	3000	042-700601
channel corner 90°/opal cover	500 × 500	042-700C01

LIGHT OPTIC COVER 40	L (mm)	ORDER CODE
linear cover	see left	006-42L0010H
continuous linear cover	6000	006-2206010H
continuous linear cover	30000	006-2230010H
blind cover	see left	006-42L001

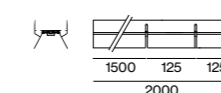
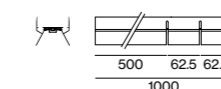

LIGHT INSET 40	L (mm)	ORDER CODE
SYSTEM POWER (MID/HIGH LUMEN)		
12.4/20.1W	1000	042-01A237
24.8/40W	2000	042-01A437
37/60W	3000	042-01A637
12.4/20.1W flex	500–1000	042-01AF37
24.8/40W flex	1500–2000	042-01AG37

LED TYPE / COVER	SYSTEM POWER	DELIVERED LM	EFFICACY
mid lumen / opal / 4000K	12.4 W/m	1430 lm/m	116 lm/W
high lumen / opal / 4000K	20.1 W/m	2240 lm/m	112 lm/W

### Spotlight Insets

see page 130

### Accessories

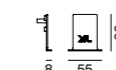

END CAPS	ORDER CODE
TYPE end caps (pair)	042-709001

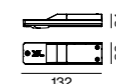

POWER FEEDER UNIT	ORDER CODE
TYPE power feeder unit	042-1093230

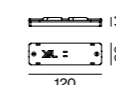

LINEAR CONNECTOR	ORDER CODE
TYPE mechanical linear connector	042-7091110
mechanical & electrical linear connector	042-7091230
opal cover linear connector	042-1091910

### MOUNTING BRACKET

TYPE	CEILING THICKNESS (mm)	ORDER CODE
mounting bracket (1 piece)	8-25	042-7092110
mounting bracket (25 pieces)	8-25	042-7092110.25

number of brackets required: length of your system in metres+1

**LUMINOUS FLUX** value calculated for 4000K, CRI ≥ 90, colour white, cover opal 3000K -5%

**Psychiatrische Klinik Königshof** Krefeld, DE –  
by alsh sander.hofrichter architekten GmbH





## MINO 40 system

ceiling/suspended

**EN** Luminaire housing from extruded aluminium profile, angular design; no visible screws; for lighting systems; powder coated; luminaire profile for mounting available in advance; remaining luminaire components mounted without tools; HPO (High Performance Opal) cover in the length of the light inset or continuous cover (both separately available); pre-assembled power rail for power supply in luminaire profile; voltage tap of the light inset on the power rail; ceiling surface mounting or suspended mounting; height adjustment without tools; with transparent feeder cable; light inset consisting of highly reflective coated extruded profile, improved thermal management; energy-eff. LEDs - very good colour rendering; optionally spotlight modules can be installed

**ES** Cuerpo de perfil de aluminio con diseño angular; sin tornillos visibles; para sistemas de iluminación; recubierto de polvo; perfil disponible para pre-montaje; resto de componentes luminosos montables sin herramienta; difusor HPO (High Performance Opal) en la longitud del inserto luminoso o difusor continuo (ambos deben encargarse por separado); carril eléctrico premont. para suministro de corr. en perfil de lumin.; toma de corr. para inserto lumin. en carril eléctrico; montaje sobre techo o suspendido; altura regulable sin herramientas; incl. cable de alimentación transparente; inserto luminoso de perfil extruido con pintura ultrarreflectante, gestión del calor mejorada; LED energét. efíc. - excelente reprod. crom.; compatible con insertos de foco

### Quickinfo

3000K, 4000K  
CRI ≥ 90, 3 SDCM  
up to 2420lm/m  
up to 123lm/W  
L85 @ 50.000h  
DALI-2

### Types

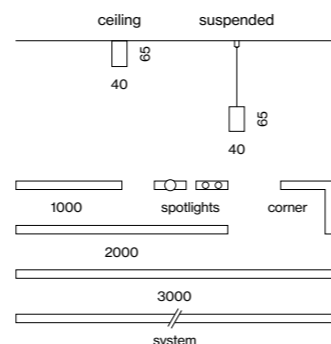

### Colours

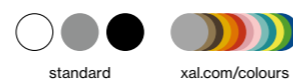

### Light distributions

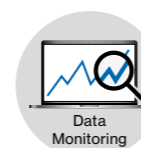

DiiA® standards  
251, 252, 253

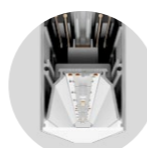

snap-in system  
(patent pending)



spotlight  
insets (p.130)



breakable  
flex insets

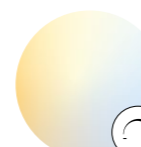

tunable white  
2700–6500K

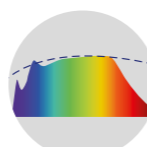

CRI ≥ 98  
XPECTRUM

### Order options

LED TYPE	
mid lumen	1
high lumen	2

COLOUR TEMPERATURE	
3000K	0
4000K	1

CONTROL	
DALI-2	

MATERIAL COLOUR	
○ pure white RAL 9010	7
● white aluminium RAL 9006	G
● jet black RAL 9005	8
● special colours	X

LENGTH	
1000mm	1
2000mm	2
3000mm	3

LIGHT OPTIC COVER	
opal high performance	

ACCESSORY COLOUR	
○ pure white RAL 9010	7
● jet black RAL 9005	8

### Options on request

COLOUR RENDERING INDEX	
CRI ≥ 98 XPECTRUM	

COLOUR TEMPERATURE	
tunable white 2700–6500K	

LIGHT OPTIC COVER	
microprismatic	

### MINO 40 ceiling/suspended



INSTALLATION CHANNEL	L (mm)	ORDER CODE
channel	1000	042-100201
channel	2000	042-100401
channel	3000	042-100601
channel corner 90°/opal cover	500 × 500	042-100C01

LIGHT OPTIC COVER 40	L (mm)	ORDER CODE
linear cover	see left	006-42L0010H
continuous linear cover	6000	006-2206010H
continuous linear cover	30000	006-2230010H
blind cover	see left	006-42L001

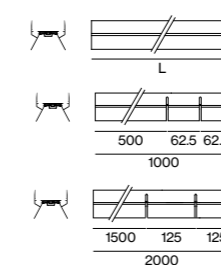

LIGHT INSET 40	L (mm)	ORDER CODE
SYSTEM POWER (MID/HIGH LUMEN)		
12.8/21W	1000	042-01A237
25.6/42W	2000	042-01A437
38/63W	3000	042-01A637
12.8/21W flex	500–1000	042-01AF37
25.6/42W flex	1500–2000	042-01AG37

LED TYPE / COVER	SYSTEM POWER	DELIVERED LM	EFFICACY
mid lumen/opal/4000K	12.8W/m	1560lm/m	122lm/W
high lumen/opal/4000K	21W/m	2420lm/m	115lm/W

### Spotlight Insets

see page 130

### Accessories

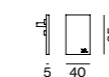

END CAPS	ORDER CODE
TYPE end caps (pair)	042-109001

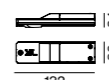

POWER FEEDER UNIT	ORDER CODE
TYPE power feeder unit	042-1093230

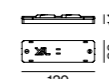

LINEAR CONNECTOR	ORDER CODE
TYPE mechanical linear connector	042-7091110
mechanical & electrical linear connector	042-7091230
opal cover linear connector	042-1091910

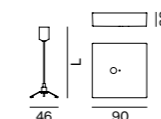

CEILING FASTENER / CABLE SUSPENSION / CANOPY	L (mm)	ORDER CODE
TYPE ceiling fastener	10	050-204111
cable suspension	1500	005-2152110
canopy		005-231121
feeder cable (transparent)		005-2412410

for electrical system configuration see luminaire data sheet at xal.com

**LUMINOUS FLUX** value calculated for 4000K, CRI ≥ 90, colour white, cover opal 3000K -5%



## SPOTLIGHT insets

profiles 40

**EN** Cylindrical spotlight made of aluminium; powder coated; spotlight can be installed without tools in MINO 40 system or FRAME 40 system; choice of single lamp or double lamps; spotlight head rotatable (WALLWASHER / FLOOR) or rotatable and tiltable (SPOTLIGHT); converter in the adapter; with optional high quality lens system with precise radiation characteristic; or high quality, aluminium, vapour deposition coated reflector with faceted design; precise radiation characteristics with different beam angles; optional asym. light distribution; good glare reduction due to recessed light point plane; optical attachments as accessories; COB (Chip on Board) technology or high power LEDs - maximum efficiency; no multiple shadows; energy-eff. LEDs - very good colour rendering

**ES** Proyector cilíndrico de aluminio; recubierto de polvo; foco puede montarse en el sistema MINO 40 o en el sistema FRAME 40 sin herramientas; con una o dos luces; cabezal de foco giratorio (WALLWASHER / FLOOR) o giratorio e inclinable (SPOTLIGHT); driver en el adaptador; opcionalmente con sistema óptico de lentes de alta calidad con precisa característica de emisión; o reflector de alta calidad vaporizado de aluminio con revestimiento de facetas esféricas; característica de emisión precisa con diferentes ángulos de emisión; opcional distribución asimétrica; buen control del deslumbramiento mediante plano de punto de luz retranqueado; los accesorios ópticos como accesorios; tecnología COB (Chip on Board) o LEDs de alta potencia - máxima eficiencia; no sombras múltiples; LED energét. efic. - excelente reprod. crom.

### Quickinfo

3000K, 4000K  
CRI ≥ 90, 2 SDCM  
spotlight 32 up to 79lm/W  
spotlight 45 up to 85lm/W  
L80 @ 50 000h  
DALI-2

### Types

#### SPOTLIGHT 32

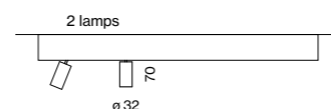

#### SPOTLIGHT 45

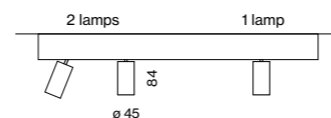

#### SPOTLIGHT 45 wallwasher floor

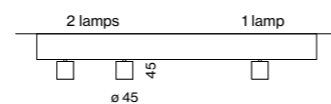

### Colours



### Light distributions



### Order options

COLOUR TEMPERATURE	
3000K	0
4000K	1

### CONTROL

DALI-2

### MATERIAL COLOUR

<input type="radio"/> traffic white RAL 9016	7
<input checked="" type="radio"/> jet black RAL 9005	8

### BEAM ANGLE

SPOTLIGHT 32	
spot 18°	S
medium 23°	M
flood 37°	F

### BEAM ANGLE

SPOTLIGHT 45	
spot 14°	S
medium 24°	M
flood 39°	F



DiiA® standards  
251, 252, 253



snap-in system  
(patent pending)



wallwasher floor  
360° rotatable



wallwasher  
floor

**LUMINOUS FLUX** value calculated for  
4000K, CRI ≥ 90, colour white, medium  
3000K -5%

### SPOTLIGHT 32

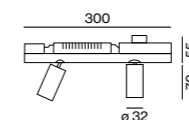

#### 2 LAMPS

SYSTEM POWER	LUMINOUS FLUX	ORDER CODE
20.6W	2 × 810lm	042-0610::3▲
honeycomb louver		007-1965188

### SPOTLIGHT 45

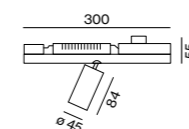

#### 1 LAMP

SYSTEM POWER	LUMINOUS FLUX	ORDER CODE
15W	spot 1060lm	042-0520::3▲S
15.9W	medium, flood 1340lm	042-0520::3▲
honeycomb louver		007-1965188

#### 2 LAMPS

SYSTEM POWER	LUMINOUS FLUX	ORDER CODE
30W	spot 2 × 1060lm	042-0620::3▲S
32W	medium, flood 2 × 1340lm	042-0620::3▲
honeycomb louver		007-1965188

### SPOTLIGHT 45 wallwasher / floor

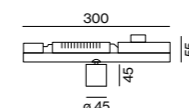

#### 1 LAMP

SYSTEM POWER	LUMINOUS FLUX	ORDER CODE
9W	659lm	042-0520::3▲W

#### 2 LAMPS

SYSTEM POWER	LUMINOUS FLUX	ORDER CODE
15.9W	2 × 659lm	042-0620::3▲W

**Corridor**  
Visualisation



## Get in contact

**EN** We develop and perfect projects in dialogue with the architects and planners to make them unique. We see ourselves as your partner. From lighting design, the right product selection and control system to commissioning and maintenance, we are at your side throughout your project. Let's talk about your project: [office@xal.com](mailto:office@xal.com)

**ES** Nuestro objetivo es colaborar directamente con arquitectos y prescriptores en el diseño y ejecución del proyecto. Proporcionamos información y asesoramiento en cualquier tipo de proyecto. Desde la selección del producto que mejor se adapta a sus necesidades a la customización de producto en el caso de ser necesario. También proporcionamos asesoramiento en cuanto a tipo de control, instalación, puesta en marcha e incluso ofrecemos servicios de mantenimiento. Contacte con nosotros: [oficina@xal.com](mailto:oficina@xal.com)

### XAL Headquarters

XAL GmbH  
Auer-Welsbach-Gasse 36  
8055 Graz  
**AUSTRIA**  
T +43.316.3170  
[office@xal.com](mailto:office@xal.com)

All locations:  
[xal.com/contacts](http://xal.com/contacts)

## List of photographers

Kris Dekeijser (Cover), Kurt Kuball (p. 52-53 | 86-87 | 98-99 | 118-119), Tim Ertl (p. 66-67), Z. Gataric Fotografie (p. 90), Dan Preston (p. 91), Oberpollinger | The KaDeWe Group (p. 95 | 100-101), Jens Pfisterer (p. 110-111), Huy Nguyen (p. 106-107), Markus Bachmann (p. 126-127)

## Legal notices

**EN** Information in this catalogue was valid at the time of printing, is non-binding, and should be used for information purposes only. We are not liable for products that differ from illustrations or information. We reserve the right to make changes to our products at any time. All orders will be accepted exclusively in accordance with our general terms and conditions of business and delivery. The latest version of these terms and conditions is available at [www.xal.com](http://www.xal.com).

**ES** Las indicaciones de este catálogo corresponden al estado de conocimientos en el momento de la impresión y se dan sin compromiso con la exclusiva finalidad de informar. No se asume ningún tipo de responsabilidad por divergencias entre un producto y las ilustraciones o indicaciones. El consumo de energía de los LED es calculado con controlador y sin instrumento operativo. Nos reservamos el derecho a realizar en cualquier momento cambios en nuestros productos. Los pedidos se aceptan exclusivamente aplicando nuestras condiciones generales comerciales y de suministro, en su redacción vigente, que pueden consultarse bajo [www.xal.com](http://www.xal.com).

