

Systems

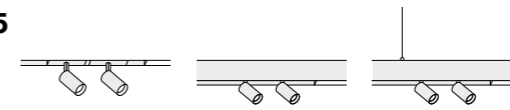

Systems

MOVE IT 25



694 recessed surface suspended

MOVE IT 45

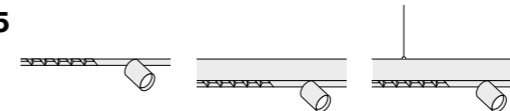

778 recessed surface suspended

TASK

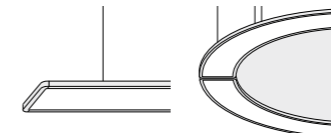

808 S suspended acoustic

BETO



834 ceiling suspended

SETA

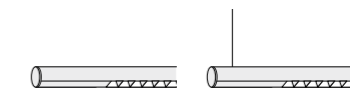

NEW 850 ceiling suspended

LENO



858 recessed semi-recessed surface suspended

MINIMAL



878 recessed

FRAME



888 recessed trim

CANYON



902 recessed offset

MINO



908 ceiling suspended

BASO



934 recessed surface

TUBO



NEW 948 surface suspended

LINEA



NEW 958 wall

Everything on track



MOVE IT 25 system

EN The sleek, elegant MOVE IT 25 system has revolutionised low-voltage track systems. The tool-free magnetic mounting of spotlights, decorative, or linear insets allows flexible, ever-new combinations. The various mounting options offer even more freedom: at two heights each, as trimless recessed and surface-mounted for wall or ceiling mounting, and suspended with a direct or direct / indirect light component. The individual profiles can be interconnected with each other, or linked via the CORNER, CURVE or NODE Connector elements. This allows for a variety of creative ceiling patterns. Square or triangular acoustic elements that can be optionally integrated additionally create balanced room acoustics.

ES Sencillo y elegante, el sistema MOVE IT 25 ha revolucionado los sistemas de carril de baja tensión: la fijación magnética y sin herramientas de proyectores y elementos decorativos o lineales ofrece posibilidades de combinación flexibles. Aun más libertad ofrecen las distintas versiones de montaje en dos alturas para el montaje empotrado o de superficie en pared o techo sin marco, o suspendido con luz directa o de luz directa / indirecta. Los distintos perfiles pueden conectarse unos con otros mediante los elementos CORNER, CURVE o NODE Connector. Esto hace posible patrones de techo creativos y variados. Unos elementos acústicos cuadrados o triangulares de integración opcional crean además una acústica ambiental óptima.

Types



25 S

25

Mountings

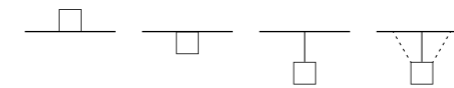
trimless
recessed

surface

suspended

indirect
suspended

Configurations



linear

corner

curve

node

flextrack

Light distributions

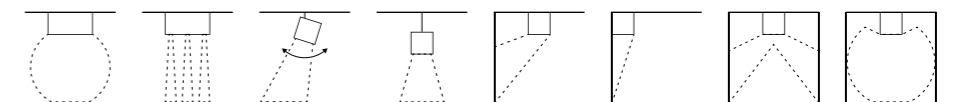

opal

spot line

spotlight

decorative

wallwasher

wall grazer

batwing

pivot

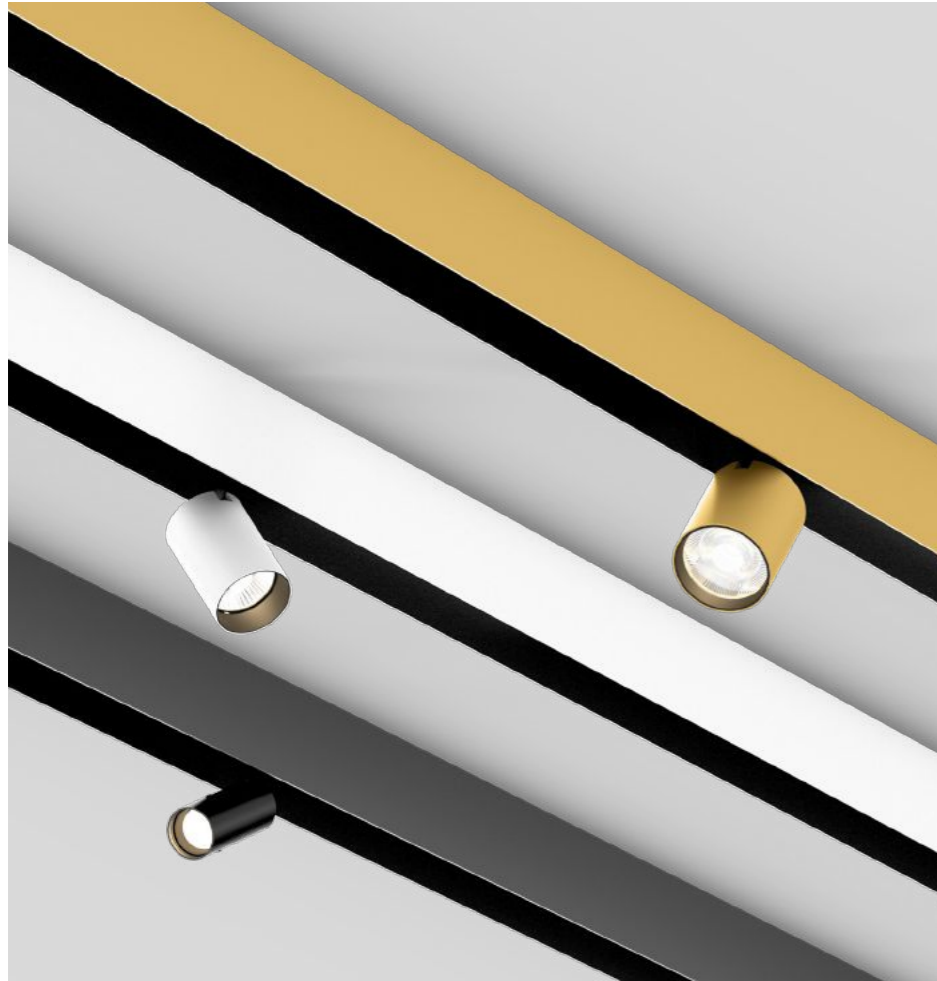

Colour variety

EN MOVE IT profiles are available in the standard colours black, white, and gold. Further colour variations are also available, granting your project maximum design freedom. You can learn more about our colour palette at xal.com/colours.

ES Los perfiles MOVE IT están disponibles en diversos colores estándar. Existe la posibilidad de utilizar una amplia paleta de colores opcionales, lo que le proporciona la máxima libertad de diseño para su proyecto. Hallará más información sobre nuestra paleta de colores en xal.com/colours.



xal.com/colours

Individual grids & room acoustics

EN The NODE Connector lets you create different ceiling patterns from up to six MOVE IT 25 profiles per node. Attractive geometric shapes are created by connecting the profiles at a 60° or 90° angle. Create seamless 90° corners with a special corner connector. Simply extend the MOVE IT Suspended System with triangular and square acoustic elements for optimised room acoustics. Curved elements and special corner connectors that are rotated 35° to the left and right provide even more design freedom.

ES NODE Connector le permite crear distintos patrones de techo con hasta seis perfiles MOVE IT 25 por nodo. Conectando los perfiles en un ángulo de 60° o 90° se obtienen atractivas formas geométricas. Para una mayor optimización de la acústica ambiental, el sistema MOVE IT Suspended puede ampliarse sencillamente con elementos acústicos triangulares o cuadrados. Para una mayor libertad de diseño pueden utilizarse elementos curvos y conectores de esquinas especiales que pueden girarse 35° a izquierda y a derecha.

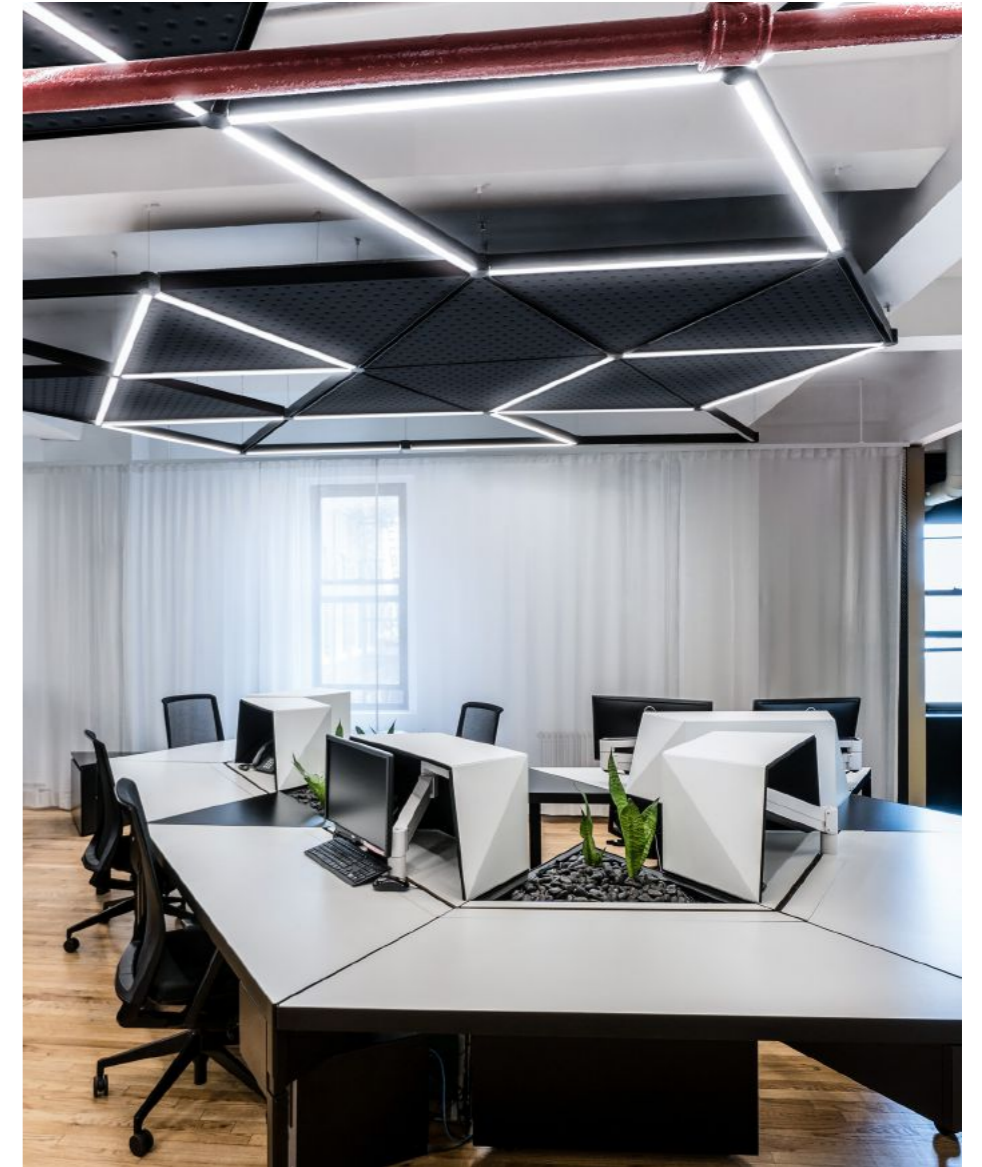

Mounting options

EN The slim, elegant MOVE IT 25 system offers a wide variety of installation options: as a trimless recessed or surface-mounted variant for wall or ceiling mounting and suspended at two depths. The direct/indirect variant provides additional homogeneous ceiling illumination.

ES El esbelto y elegante sistema MOVE IT 25 ofrece una gran variedad de posibilidades de montaje, con versiones empotradas o de superficie sin marco para el montaje en pared o techo y otra de suspensión en dos alturas de carril diferentes. La versión Direct/Indirect garantiza una iluminación homogénea adicional del techo.

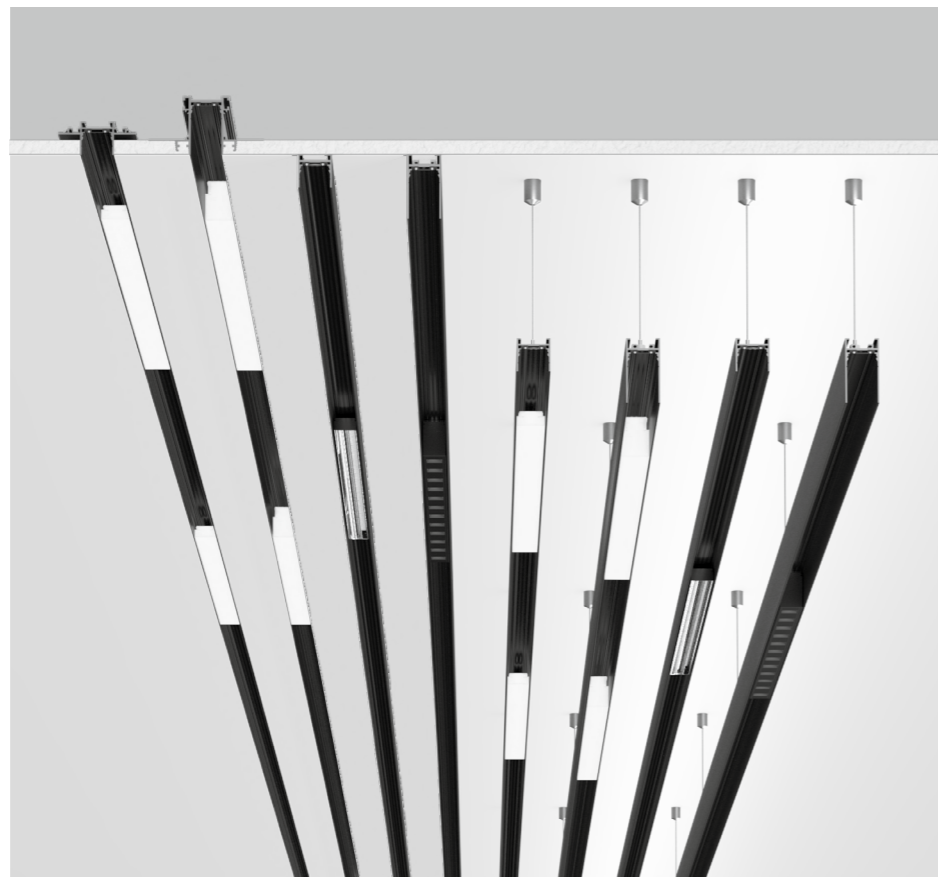
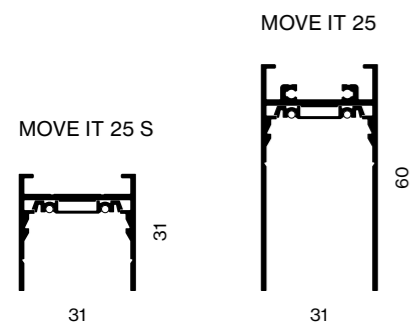

XPECTRUM LED

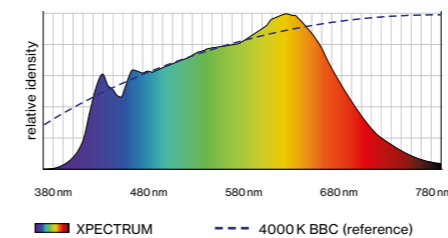

Commercially available LED 4000K

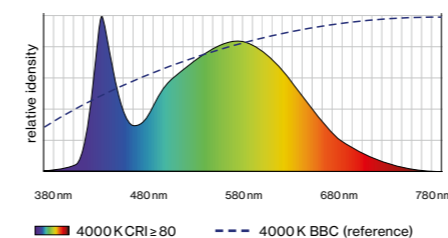

Full-spectrum LED

EN XAL's new XPECTRUM LEDs deliver healthy, biologically effective light. The reduced blue light and increased cyan values reduce the blue light hazard for the eye to daylight-equivalent levels. The resulting non-visual, so-called melanopic light effect, improves concentration and increases sleep quality. The excellent colour rendering of IES TM 30-15 $R_i = 98$ and $R_g = 101$ further helps visual comfort.

ES El nuevo LED XPECTRUM de XAL ofrece una luz saludable con efectos biológicos. La menor proporción de luz azul y el aumento de los valores de cian minimizan el riesgo de la incidencia de luz azul en el ojo, manteniéndola a un nivel similar al presente en la luz natural. El efecto no visible resultante, denominado efecto melanópico, fomenta la concentración y mejora la calidad del sueño. Además, su excelente reproducción cromática –con índices $R_i = 98$ y $R_g = 101$ según la norma IES TM-30-15– garantiza una mayor comodidad visual.



Optical accessories

EN Use a wide range of optical accessories to adapt spotlights for special applications. The optical light accessories can be attached or removed in one easy step and provide glare-free light at any point.

ES Utilice accesorios ópticos para adaptar los proyectores a campos de aplicación especiales. Los accesorios ópticos pueden ponerse y quitarse con total facilidad y garantizan una luz exenta de deslumbramiento en cualquier lugar.

Control options

EN MOVE IT Insets are available with DALI-2 and can be controlled individually. Configuration and control are simply done via DALI. As the open DALI communication standard is fully supported, all compatible luminaires can be easily integrated into the system. The Wireless-to-DALI Inset enables wireless control of DALI luminaire systems by using a communication module.

ES Los insertos MOVE IT están disponibles con DALI-2 y pueden controlarse individualmente. La configuración y el control se efectúan fácilmente a través de DALI. Ya que el sistema admite totalmente el uso del estándar de comunicación abierto DALI, todas las luminarias compatibles pueden integrarse en él con facilidad. El inserto "Wireless to DALI" posibilita el control sin cable de sistemas de luminarias DALI utilizando un módulo de comunicación.

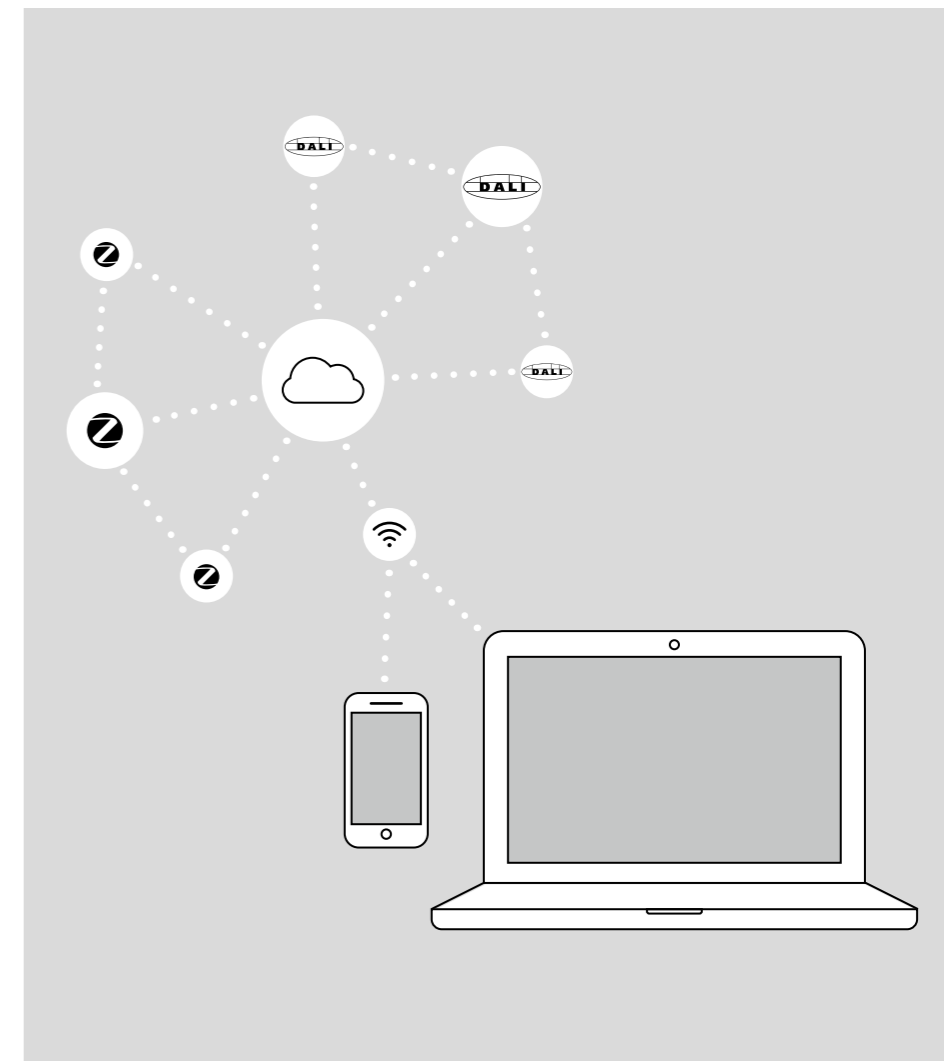

Magnetic attachment

EN MOVE IT Insets are mounted without tools and magnetically fixed within the profile. They can, therefore, be adjusted and adapted according to the lighting requirements with just one movement.

ES Los elementos en el MOVE IT se montan sin herramientas y se fijan magnéticamente en el interior del perfil. Esto les permite ajustarse y adaptarse con total facilidad según los requisitos de la iluminación.

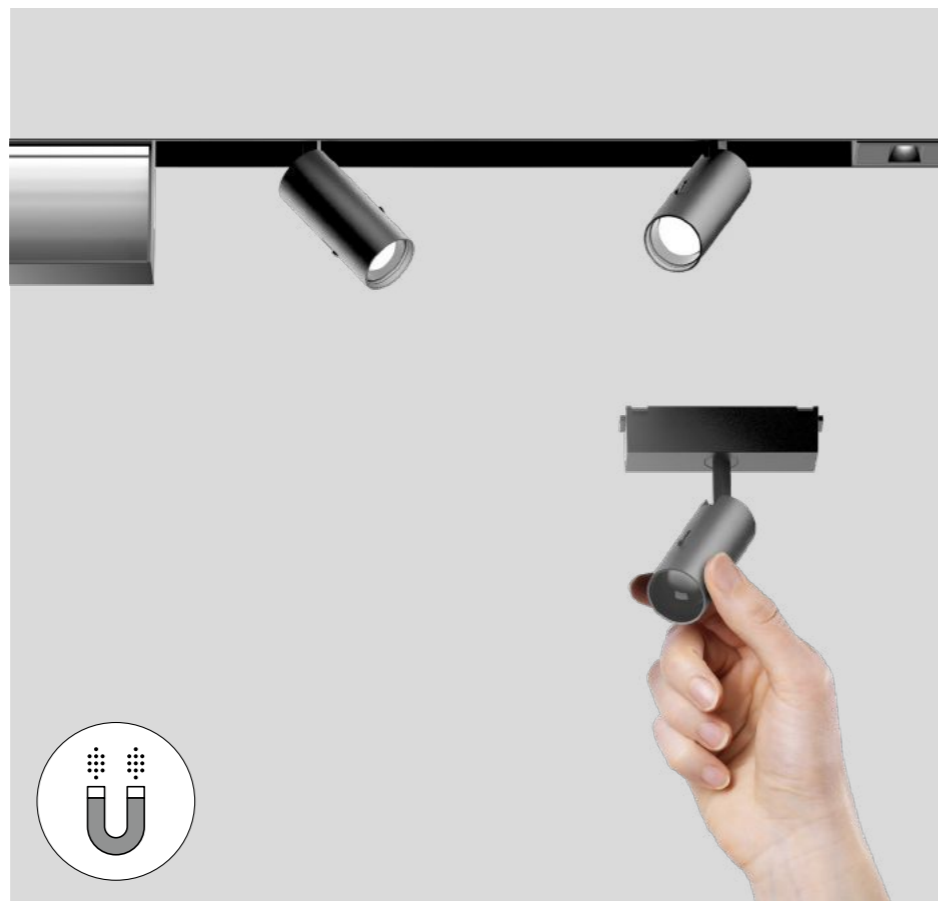

IoT ready

EN IoT ready refers to the possibility of equipping luminaires with smart sensor technology. You receive valuable information, such as your lighting system's energy consumption or your rooms' utilisation over the day. You can set shut-off delay times and brightness values or plan time-controlled light sequences. The sensor is magnetically inserted into the track system like a spotlight and can be individually configured without restriction by existing standards.

ES "IoT ready" indica la posibilidad de equipar a las luminarias con sensores inteligentes. Esto le permitirá obtener información valiosa, tal como el consumo de energía de su sistema de iluminación o el grado de utilización de las salas en el transcurso del día. También es posible establecer tiempos de desconexión y valores de luminosidad, así como programar transiciones luminosas reguladas por temporizador. El sensor se fija magnéticamente al sistema de carriles como un foco, y puede configurarse de forma totalmente individual sin ningún tipo de restricciones por estándares existentes.

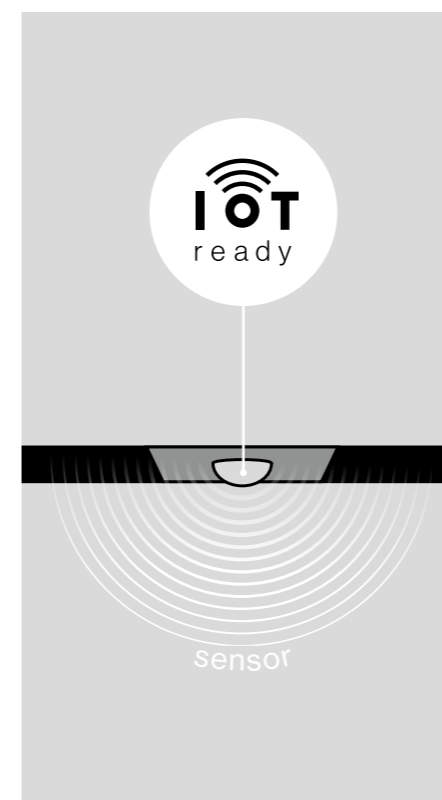

← back



MOVE IT 25 S system

trimless / surface / suspended

EN Thin extruded aluminium profile with 31mm height and 28mm width groove; optionally for trimless installation in plasterboard ceilings (wall or ceiling mounting) with 12.5mm ceiling thickness; or for wall-/ceiling surface mounting or suspended mounting (cable suspension, height adjustment without tools, incl. black feed); optional with indirect light component for additional accentuation of the ceiling; for lighting systems; linear, 90° angle connectors or 90° CURVE segment; with integrated power track profile for take off of supply voltage and DALI signal; surface anodised or powder coated; insets can be installed flexibly and without tools by means of magnetic holders + locking

ES Perfil de aluminio extrusionado plano con una altura de 31mm y con ancho de junta de 28mm; disponible para el encastre sin bordes en techos de cartón yeso (montaje en pared o techo) de 12,5mm de espesor; o para montaje sobre pared/techo o suspendido (suspensión por cable, ajuste de altura sin herramienta, cable de alimentación negro incluido); opcional con componentes de luz indirectos para el realce adicional del techo; para sistemas de iluminación; lineal, conector acodado de 90° o elemento CURVE de 90°; con perfil de rail electrificado integrado para la recepción de la tensión de alimentación y DALI; superficie anodizada o recubierto de polvo; montaje flexible y sin herramienta de los elementos insertables mediante un soporte magnético con bloqueo

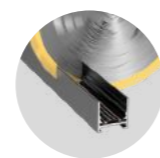

custom cut on building site

Quickinfo

3000K
CRI ≥ 90, 2 SDCM
up to 117lm/W
L80 @ 50000h
non DIM, DALI-2

Types

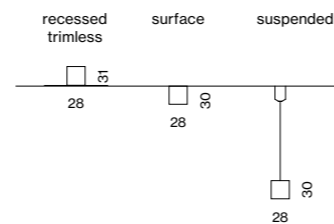

connector



corner curve

Colours



Order options

CONTROL	
non DIM	1
DALI-2	3

MATERIAL COLOUR

● jet black RAL 9005

Options on request

CONNECTOR

T-connector

X-connector

INSTALLATION TRACK

acoustic soft ceilings



MOVE IT 25 S trimless



INSTALLATION TRACK

L (mm)		ORDER CODE
617	channel	050-72120
1217	channel	050-72140
2417	channel	050-72180
3622	channel	050-72190
cust. cut	channel (non DIM)	E83131
cust. cut	channel (DALI-2)	E83141
672x645	channel corner* 90°	050-72110
661x661	channel corner* ceiling to wall 90°	050-72111

*incl. electrical connector set

Accessories

END CAPS

TYPE	ORDER CODE
end caps (pair)	050-7210008

BLIND COVER

L (mm)	ORDER CODE
1217	050-7004008
2417	050-7008008
3622	050-7009008
custom cut	E83000

blind cover can be shortened as desired

CONNECTOR SET

TYPE	ORDER CODE
linear connector (non DIM, DALI-2)	050-2031130
linear connector flexible	050-20321
mechanical linear connector (pair)	050-2011110

POWER FEEDER UNIT

TYPE	ORDER CODE
non DIM 2 × 2,5mm ²	050-2020110
DALI-2 2 × 2,5 + 2 × 0,5mm ²	050-2020130

cable length 500mm

Electrical accessories

see page 708

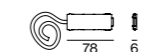
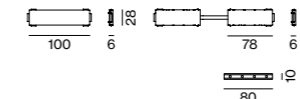
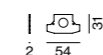
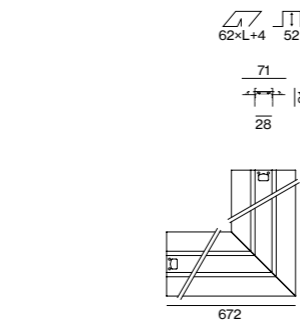

← back

Order options

CONTROL

non DIM	1
DALI-2	3

MATERIAL COLOUR

● jet black RAL 9005	8
● traffic white 9016 / jet black 9005 P	
● gold dust 260-M / jet black 9005 G	
● special colours* p.992 X	

*inside always in black

MATERIAL COLOUR ACCESSORIES

○ traffic white RAL 9016	7
● jet black RAL 9005	8

MATERIAL COLOUR CABLE SUSPENSION

chrome	0
black	8

Options on request

CONNECTOR

T-connector	
X-connector	



MOVE IT 25 S surface/suspended

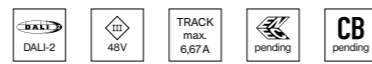

INSTALLATION TRACK / BLIND COVER

L (mm)		ORDER CODE
620	channel	050-73120
1220	channel	050-73140
2420	channel	050-73180
3625	channel	050-73190
cust. cut	channel (non DIM)	E83151
cust. cut	channel (DALI-2)	E83161
637x610	channel corner* 90°	050-73110
666x666	channel corner* ceiling to wall 90°	050-73111

*incl. electrical connector set

1217	blind cover	050-7004008
2417	blind cover	050-7008008
3622	blind cover	050-7009008
cust. cut	blind cover	E83000

CURVE CONNECTOR

TYPE	ORDER CODE
mechanical & electrical R 300 mm	050-731303
mechanical R 300 mm	050-731311

Accessories

END CAPS

TYPE	ORDER CODE
end caps (pair)	050-731000

CONNECTOR SET

TYPE	ORDER CODE
mechanical linear conn. incl. 1500mm cable susp.	050-201131
mechanical linear connector surface	050-2011210
mechanical & electrical linear connector	050-2031230
mechanical & electrical corner connector flex	050-2032238

POWER FEEDER UNIT

TYPE	ORDER CODE
non DIM 2x2,5mm ²	050-2022110
DALI-2 2x2,5 + 2x0,5mm ²	050-2022130

cable length 2000 mm

CEILING FASTENER / CABLE SUSPENSION / CANOPY

TYPE	L (mm)	ORDER CODE
ceiling fastener	10	050-204111
cable suspension	1500	005-215211
canopy		005-231121

*use every 1200 mm

Electrical accessories

see page 708

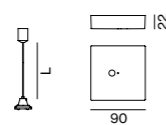
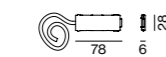
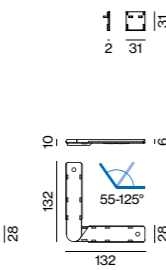
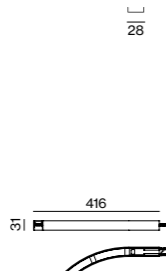
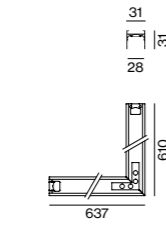

Order options

COLOUR TEMPERATURE

3000K	
-------	--

CONTROL

non DIM	1
DALI-2	3

MATERIAL COLOUR

● jet black RAL 9005	8
● traffic white 9016 / jet black 9005 P	
● gold dust 260-M / jet black 9005 G	
● special colours* p.992 X	

*inside always in black

MATERIAL COLOUR ACCESSORIES

○ traffic white RAL 9016	7
● jet black RAL 9005	8

MATERIAL COLOUR CABLE SUSPENSION

chrome	0
black	8

Options on request

COLOUR RENDERING INDEX

CRI ≥ 98 XPECTRUM	
-------------------	--

COLOUR TEMPERATURE

2700K	
4000K	
tunable white 2700-6500K*	

*DALI-2 DT8

CONNECTOR

T-connector	
X-connector	



MOVE IT 25 S suspended indirect



INSTALLATION TRACK INDIRECT

L (mm)	SYSTEM POWER	LUMINOUS FLUX	ORDER CODE
620	6.2W	638lm	050-74125
1220	15W	1790lm	050-74145
2420	33W	3830lm	050-74185
3625	50W	5745lm	050-74195
637x610	13W	1530lm	050-74110

corner* no custom cut on building side; *incl. electrical connector set

1217	blind cover	050-7004008
2417	blind cover	050-7008008
3622	blind cover	050-7009008
cust. cut	blind cover	E83000

Accessories

END CAPS

TYPE	ORDER CODE
end caps (pair)	050-731000

CONNECTOR SET

TYPE	ORDER CODE
mechanical linear conn. incl. 1500mm cable susp.	050-201131
mechanical & electrical linear connector	050-2031230
mechanical & electrical corner connector flex	050-2032238

POWER FEEDER UNIT

TYPE	ORDER CODE
non DIM 2x2,5mm ²	050-2022110
DALI-2 2x2,5 + 2x0,5mm ²	050-2022130

cable length 2000 mm

CABLE SUSPENSION / CANOPY

TYPE	L (mm)	ORDER CODE
cable suspension	1500	005-215211
canopy		005-231121

*use every 1200 mm

Electrical accessories

see page 708

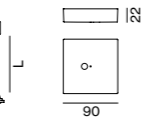
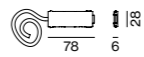
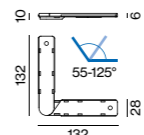
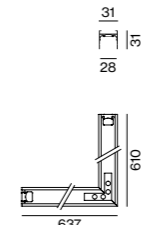

back



MOVE IT 25 system

trimless / surface / suspended

EN Extruded aluminium profile with 28 mm width groove; for trimless installation in plasterboard ceilings (wall or ceiling mounting) with 12.5 mm ceiling thickness; or for wall-/ceiling surface mounting or suspended mounting (cable suspension, height adjustment without tools, incl. black feed); optional indirect light component for additional accentuation of the ceiling; for lighting systems; linear, 90° angle connectors or 90° CURVE segment; node connectors, up to 6 profile connection options; with power track profile for take off of supply voltage and DALI signal; surf. anod. or powder coated; insets can be installed flexibly and without tools by means of magnetic holders + locking; sound absorbing accessories available

ES Perfil de aluminio extruido con ancho de junta de 28 mm; para encastre sin bordes en planchas cartón yeso (montaje pared o techo) de 12,5 mm espesor; o para montaje sobre pared/techo o suspendido (suspensión por cable, ajuste de altura sin herramienta, cable de alimentación negro incluido); opcional componentes de luz indirectos para el realce adicional del techo; para sistemas de iluminación; lineal, conector acodado de 90° o elemento CURVE de 90°; conector de nodos, conexión de hasta 6 perfiles; con perfil de rail electrificado para la recepción de la tensión de alimentación y DALI; superf. anodiz. o recub. de polvo; montaje flexible y sin herramienta de los elementos insertables mediante un soporte magnético con bloqueo; disponible accesorio para la absorción del ruido

Quickinfo

3000K
CRI ≥ 90, 2 SDCM
up to 117lm/W
L80 @ 50 000h
non DIM, DALI-2

Types

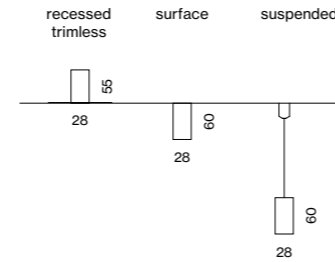

connectors

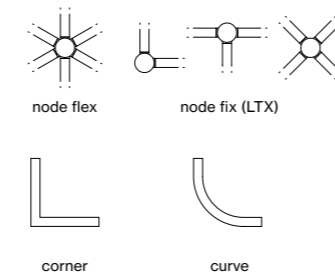

Colours



Order options

CONTROL	
non DIM	1
DALI-2	3

MATERIAL COLOUR

● jet black RAL 9005

Options on request

CONNECTOR

T-connector
X-connector

INSTALLATION TRACK

acoustic soft ceilings

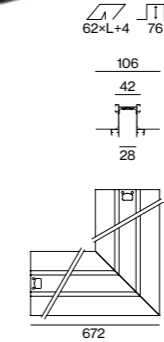

MOVE IT 25 trimless



INSTALLATION TRACK

L (mm)		ORDER CODE
617	channel	050-72020-8
1217	channel	050-72040-8
2417	channel	050-72080-8
3622	channel	050-72090-8
cust. cut	channel (non DIM)	E83031-8
cust. cut	channel (DALI-2)	E83041-8
672x645	channel corner* 90°	050-72010-8
661x661	channel corner* ceiling to wall 90°	050-72011-8

*incl. electrical connector set

Accessories

END CAPS

TYPE	ORDER CODE
end caps (pair)	050-72000-8

BLIND COVER

L (mm)	ORDER CODE
1217	050-70040-8
2417	050-70080-8
3622	050-70090-8
custom cut	E83000-8B

blind cover can be shortened as desired

CONNECTOR SET

TYPE	ORDER CODE
linear connector (non DIM, DALI-2)	050-20311-30
linear connector flexible	050-20321-0
mechanical linear connector (pair)	050-20111-10

POWER FEEDER UNIT

TYPE	ORDER CODE
non DIM 2 × 2,5 mm ²	050-20201-10
DALI-2 2 × 2,5 + 2 × 0,5 mm ²	050-20201-30

cable length 500 mm

Electrical accessories

see page 708

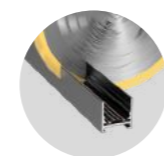

custom cut on building site



acoustic elements (p. 772)

[back](#)

Order options

- CONTROL** ▶
- non DIM 1
 - DALI-2 3

- MATERIAL COLOUR** ▶
- traffic white RAL 9016 7
 - jet black RAL 9005 8



Electrical accessories

POWER SUPPLY INTRACK supply 220-240 V AC, 48 V, 50-60 Hz

TYPE	EFFICIENCY	MOUNTING	L-W-H (mm)	ORDER CODE
100W <input checked="" type="checkbox"/> PC II	η 92%	intrack	403-26-46	050-2071038
150W <input checked="" type="checkbox"/> PC II	η 92%	intrack	403-26-46	050-2071138

ENEC approved, incl. feeder cable 2000mm; DALI-2 SELV device integrated

POWER SUPPLY SURFACE supply 220-240 V AC, 48 V, 50-60 Hz

TYPE	EFFICIENCY	MOUNTING	L-W-H (mm)	ORDER CODE
60W <input checked="" type="checkbox"/> PC II	η 88%	surface	305-144-54	050-2055134
100W <input checked="" type="checkbox"/> PC II	η 92%	surface	455-104-40	050-2055434
150W <input checked="" type="checkbox"/> PC II	η 92%	surface	455-104-40	050-2055234
250W <input checked="" type="checkbox"/> PC II	η 93%	surface	455-104-40	050-2055534
320W <input checked="" type="checkbox"/> PC I	η 94%	surface	305-144-54	050-2055334

ENEC approved, incl. feeder cable 2000mm; DALI-2 SELV device integrated

POWER SUPPLY EXTERNAL supply 220-240 V AC, 48 V, 50-60 Hz

TYPE	EFFICIENCY	MOUNTING	L-W-H (mm)	ORDER CODE
60W <input checked="" type="checkbox"/> PC II	η 88%	external	163-43-32	002-62133
100W <input checked="" type="checkbox"/> PC II	η 92%	external	350-30-18	002-62134
150W <input checked="" type="checkbox"/> PC II	η 92%	external	350-30-18	002-62135
250W <input checked="" type="checkbox"/> PC II	η 93%	external	400-40-22	002-62139
320W <input checked="" type="checkbox"/> PC I	η 94%	external	252-90-44	002-60320

ENEC approved, incl. feeder cable 2000mm

DIN RAIL POWER SUPPLY BASIC 48 V
220-240 V | 50-60 Hz | PC II | MTBF @ 55° ambient temperature

TYPE	EFFICIENCY / MTBF	W-H-D (mm)	ORDER CODE
96W	η 89% / >300.000h	90-90-60	005-6520010

DIN RAIL POWER SUPPLY PRO 48 V
220-240 V | 50-60 Hz | PC I | MTBF @ 55° ambient temperature
cascadable max. 5 devices (240 W) or 3 devices (480 W)

TYPE	EFFICIENCY / MTBF	W-H-D (mm)	ORDER CODE
240W	η 92% / >400.000h	60-125-100	005-6220110
480W	η 93% / >350.000h	120-125-100	005-6220210

DALI-2 SELV DEVICE

TYPE	L-W-H (mm)	ORDER CODE
control unit	213-37-25	050-2061130

necessary to create DALI-2 SELV signal; DALI power supply integrated

DALI SENSOR

TYPE	L-W-H (mm)	ORDER CODE
ESSENTIAL sensor (brightness & presence)	125-28-45	050-2063178

WIRELESS TO DALI-2 CONTROL DEVICE

TYPE	L-W-H (mm)	ORDER CODE
Zigbee 3.0	111-25-45	050-2065130
Casambi	111-25-45	050-2065230

DALI-2 SELV device required

WIRELESS TO DALI-2 REPEATER

TYPE	L-W-H (mm)	ORDER CODE
Zigbee 3.0	111-25-45	050-2066130
Casambi	111-25-45	050-2066230

MIDDLE FEED

TYPE	ORDER CODE
non DIM 2x2,5mm ²	050-2038110
DALI-2 2x2,5 + 2x0,5mm ²	050-2038130

cable length 2000mm

Blique by Nobis
Stockholm, SE -
by Wingårdhs

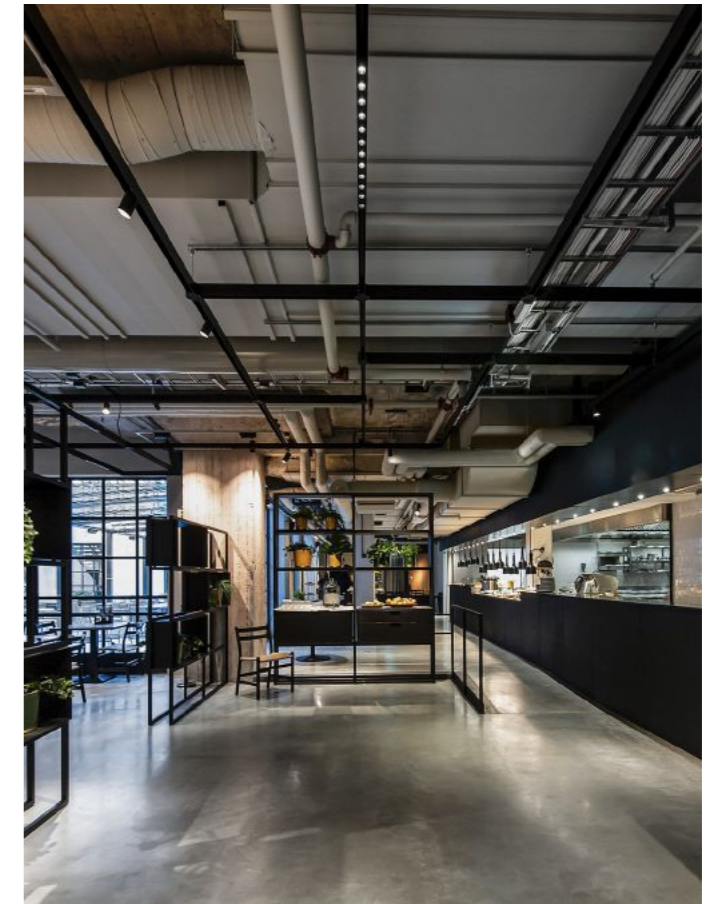

← back



JUST
spotlight inset 25/25 S

Quickinfo

2700K, 3000K, 4000K, TW, CWD
CRI ≥ 90, 2 SDCM
non DIM, DALI-2

L95 @ 50 000h
JUST 32 focus up to 47lm/W

L80 @ 50 000h
JUST 45 up to 72lm/W

L90 @ 50 000h
JUST 55 up to 75lm/W

Types



Colours



Light distributions

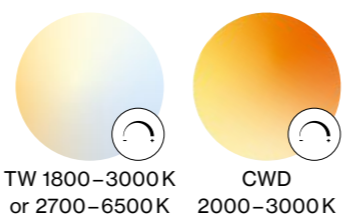
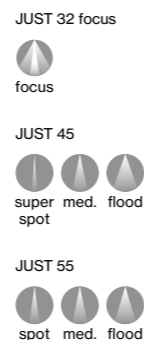

Order options

COLOUR TEMPERATURE

2700K	4
3000K	5
4000K	6
colour warm dim. 2000-3000K*	
tunable white 1800-3000K**	
tunable white 2700-6500K**	

*DALI-2 **DALI-2 DT8

CONTROL

non DIM	1
DALI-2	3

MATERIAL COLOUR

○ traffic white RAL 9016	7
● jet black RAL 9005	8
● special colours p. 992	X

BEAM ANGLE JUST 45

medium 23°	M
flood 44°	F

BEAM ANGLE JUST 55

spot 16°	S
medium 28°	M
flood 37°	F

Options on request

OPTICAL ACCESSORIES
elliptical sculpture foil
snoot
colour filter (red, blue, green, etc.)
only for JUST 32 focus

INSET POWER in watts is the current consumption excluding any ballast
LUMINOUS FLUX value calculated for 3000K, CRI ≥ 90, colour white, lens flood
2700K -5%, 4000K +5%

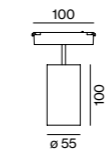
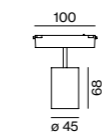
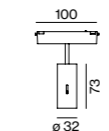

JUST 32 focus 17-43°



SPOTLIGHT

INSET POWER	LUMINOUS FLUX	ORDER CODE
8.3W	393lm	050-01111

JUST 45



SPOTLIGHT

INSET POWER	LUMINOUS FLUX	ORDER CODE
6.1W super spot 8°	297lm	050-01313
11W	788lm	050-01311
12W CWD 2000-3000K	430lm	050-0131E3
11W TW 1800-3000K	555lm	050-0131L3
11W TW 2700-6500K	683lm	050-0131D3

JUST 55



SPOTLIGHT

INSET POWER	LUMINOUS FLUX	ORDER CODE
15.9W	1300lm	050-01433
30W	2090lm	050-01423

Optical accessories

HONEYCOMB LOUVER

TYPE	Ø-H (mm)	ORDER CODE
JUST 32 focus	30·4	007-1965168
JUST 45	42·3	007-1965188
JUST 55	50·3	007-1965598



Hotel & Restaurant Mühlthof
Neufelden, AT –
by AllesWirdGut Architekten



Private Residence Århus, DK –
by Friis Moltke Architects
with lighting design by anker & co



Petersen Tegl Copenhagen, DK –
by Annette Petersen & Peter Zinck
with lighting design by anker & co



Office of ENTASIS Architects
Copenhagen, DK –
by Christian Cold including lighting
design by Christian Cold / anker & co





Autodesk Krakow, PL –
by The Design Group with
lighting design by Plus Lighting





Büroausbau in Soho
London, UK – by Design Haus
Liberty / DHL with lighting design
by Alkestie Skarlatou, lightinspace



The Raum Bolzano, IT –
by bergundtal gmbh.



Design Fair Marbella, ES –
by Welcome Design



Quickinfo

non DIM, DALI-2

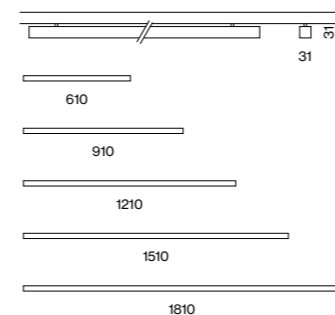
Types**Colours****Order options****CONTROL**

non DIM	1
DALI-2	3

MATERIAL COLOUR

● jet black RAL 9005	8
● traffic white 9016 / jet black 9005 P	
● gold dust 260-M / jet black 9005 G	
● special colours* ● p. 992	X

*inside always in black

MOVE IT 25 S**FLEXTRACK**

L (mm)

L (mm)	ORDER CODE
610	050-45120
910	050-45130
1210	050-45140
1510	050-45150
1810	050-45160

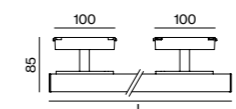
MOVE IT 25**FLEXTRACK**

L (mm)

L (mm)	ORDER CODE
610	050-45020
910	050-45030
1210	050-45040
1510	050-45050
1810	050-45060

**FLEXTRACK**

system extension 25/25S

EN Thin extruded aluminium profile with 31mm height and 28mm width groove; with integrated power track profile for take off of supply voltage and DALI signal; surface anodised or powder coated; for installation in two MOVE IT 25 or 25 S profiles; profile can be installed and moved without tools by means of magnetic holders+locking; mount 360° rotatable and freely slidable on one end; light insets can be installed flexibly and without tools by means of magnetic holders+locking

ES Perfil de aluminio extruido plano de 31mm de alto y 28 mm de ancho de junta; con perfil de carril electrificado integrado para toma de suministro eléct. y señal DALI; superficie anodiz. o recub. de pintura en polvo; para inserción en dos perfiles MOVE IT 25 o MOVE IT 25 S; perfil insertable y desplazable sin herramienta mediante soporte magnético con bloqueo; soporte girable a 360° y libremente desplazable en un extremo; montaje flexible y sin herramienta de los elementos de luz mediante soporte magnético con bloqueo

Jewelery + Optical Store
Ludwigsburg, DE –
by Ippolito Fleitz Group –
Identity Architects



← back

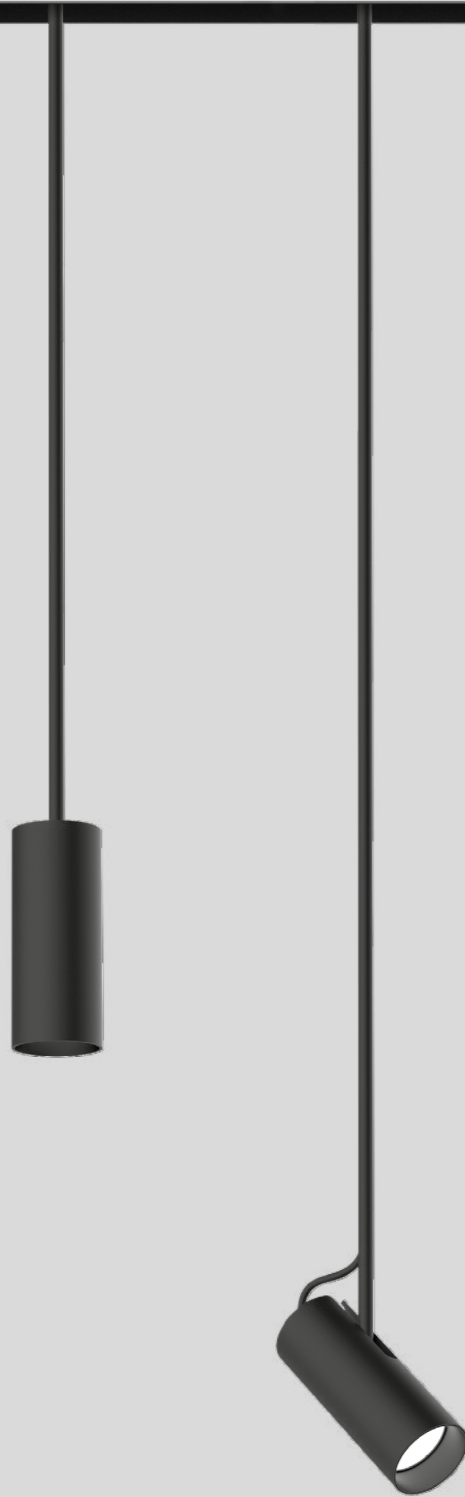

Quickinfo

2700 K, 3000 K, 4000 K, TW
 CRI ≥ 90, 3 SDCM
 up to 84 lm/W
 L90 @ 50 000 h
 non DIM, DALI-2

Types

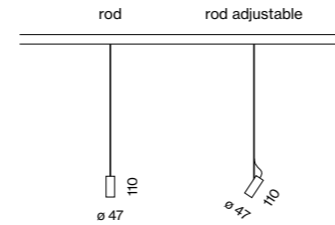

Colours

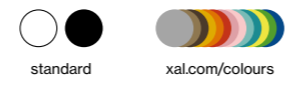

Light distributions



Order options

CABLE SUSPENSION

1500 mm	5
2000 mm with hook*	6

*one ring included

COLOUR TEMPERATURE

2700 K	4
3000 K	5
4000 K	6
tunable white 2200–4000 K*	

*DALI-2 DT8

CONTROL

non DIM	1
DALI-2	3

MATERIAL COLOUR

○ traffic white RAL 9016	7
● jet black RAL 9005	8
● special colours p. 992	X

ACCESSORY COLOUR

○ traffic white RAL 9016	7
● jet black RAL 9005	8

BEAM ANGLE

medium 25°	M
flood 44°	F

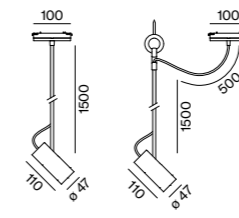
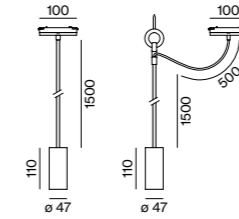

ARY rod



DOWNLIGHT

INSET POWER	COLOUR TEMP.	LUMINOUS FLUX	ORDER CODE
14 W	2700 K	1050 lm	0 5 0 - 0 3 2 1
	3000 K	1100 lm	
	4000 K	1180 lm	
5.4 W TW	2200–4000 K	284 lm	0 5 0 - 0 3 2 1 D 3

ARY rod adjustable

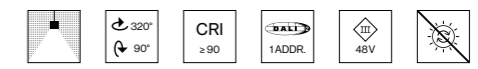

SPOTLIGHT

INSET POWER	COLOUR TEMP.	LUMINOUS FLUX	ORDER CODE
14 W	2700 K	1050 lm	0 5 0 - 0 3 3 1
	3000 K	1100 lm	
	4000 K	1180 lm	
5.4 W TW	2200–4000 K	284 lm	0 5 0 - 0 3 3 1 D 3

Mounting accessories

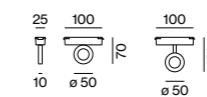

RING track mounted

TYPE	Ø-H (mm)	ORDER CODE
MOVE IT 25 S	50-70	0 5 0 - 1 5 1 0 1 1
MOVE IT 25	50-91	0 5 0 - 0 5 1 0 1 1



RING ceiling mounted

TYPE	Ø-H (mm)	ORDER CODE
MOVE IT 25S/25	50-88	0 5 0 - 0 5 1 0 2 1

reddot winner 2020

DESIGN AWARD 2020

ARY rod
 decorative inset 25/25 S

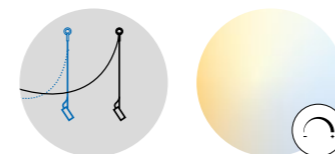

free positioning by ring and hook tunable white 2200 – 4000 K

LUMINOUS FLUX value calculated for CRI ≥ 90, colour white, lens flood

← back



 red dot winner 2020

 DESIGN AWARD 2020

ARY cable
decorative inset 25/25 S

Quickinfo

2700 K, 3000 K, 4000 K, TW
CRI ≥ 90, 3 SDCM
up to 84 lm/W
L90 @ 50 000 h
non DIM, DALI-2

Types

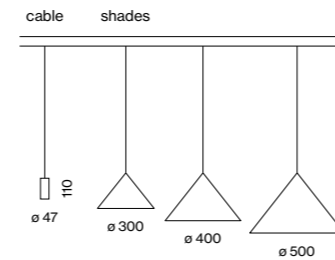

Colours



Light distributions

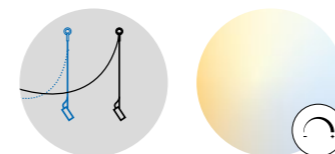

free positioning by ring and hook tunable white 2200 – 4000 K

Order options

CABLE SUSPENSION 

1500 mm	5
2000 mm with hook*	6

*one ring included

COLOUR TEMPERATURE 

2700 K	4
3000 K	5
4000 K	6
tunable white 2200–4000 K*	

*DALI-2 DT8

CONTROL 

non DIM	1
DALI-2	3

MATERIAL COLOUR 

○ traffic white RAL 9016	7
● jet black RAL 9005	8
 special colours  p. 992	X

ACCESSORY COLOUR 

○ traffic white RAL 9016	7
● jet black RAL 9005	8

BEAM ANGLE 

medium 25°	M
flood 44°	F

SHADE COLOUR 

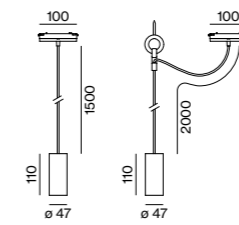

● velvet beige RAL 085 80 10	C
● madeira brown RAL 050 40 40	T
● kingfisher grey RAL 230 60 10	L
● woodpecker olive RAL 1050 20	G
○ signal white RAL 9003	W
● signal black RAL 9004	B



ARY cable





DOWNLIGHT

INSET POWER	COLOUR TEMP.	LUMINOUS FLUX	ORDER CODE
14 W	2700 K	1050 lm	0 5 0 - 0 5 1 1 1 
	3000 K	1100 lm	
	4000 K	1180 lm	
5.4 W TW	2200–4000 K	284 lm	0 5 0 - 0 5 1 1 D 3 

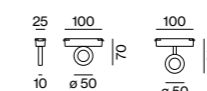
Mounting accessories



RING track mounted

TYPE	Ø-H (mm)	ORDER CODE
MOVE IT 25 S	50-70	0 5 0 - 1 5 1 0 1 1 
MOVE IT 25	50-91	0 5 0 - 0 5 1 0 1 1 





RING ceiling mounted

TYPE	Ø-H (mm)	ORDER CODE
MOVE IT 25S/25	50-88	0 5 0 - 0 5 1 0 2 1 

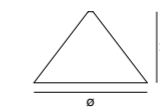
Optical accessories



SHADE

TYPE	Ø-H (mm)	ORDER CODE
cone 300	300-188	0 4 9 - 5 9 3 3 1 1 
cone 400	400-253	0 4 9 - 5 9 3 4 1 1 
cone 500	500-318	0 4 9 - 5 9 3 5 1 1 

only available for ARY cable

LUMINOUS FLUX value calculated for CRI ≥ 90, colour white, lens flood



Noma 2.0
Copenhagen, DK –
by BIG with interior design
by Studio David Thulstrup



Gwerder Fidel Energietechnik AG
Ibach, CH – by FORM
Innenarchitektur GmbH



← back

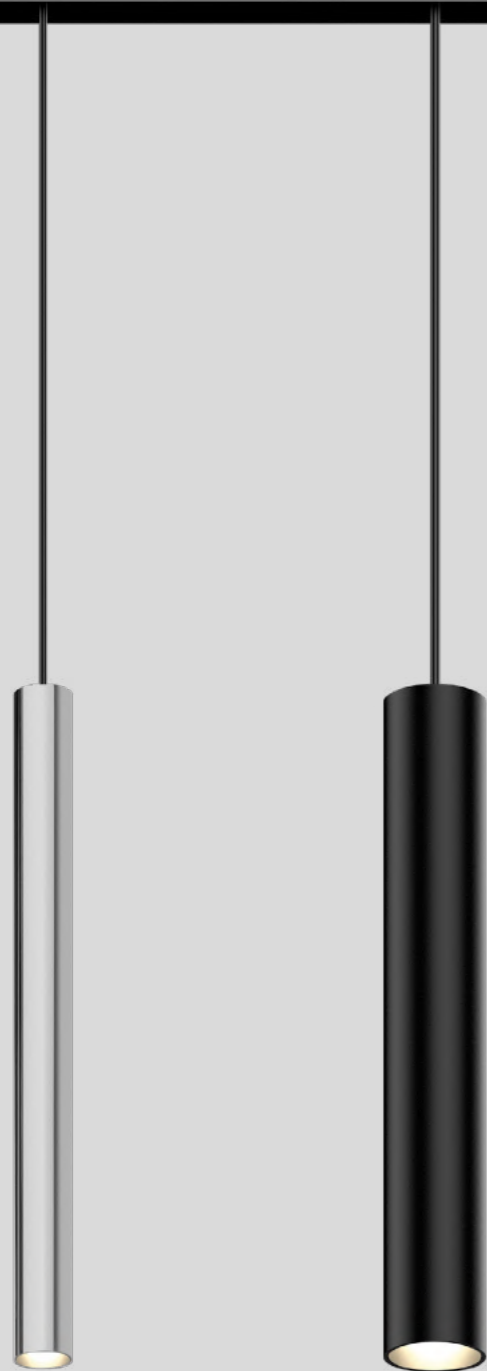

Quickinfo

2700K, 3000K, TW
 CRI ≥ 90, 3 SDCM
 up to 75 lm/W
 L80 @ 50 000 h
 non DIM, DALI-2

Types

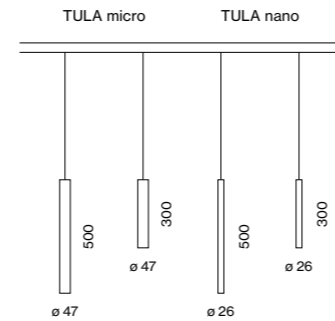

Colours



Light distributions



Order options

HOUSING HEIGHT

300 mm	0
500 mm	1

CABLE SUSPENSION

1500 mm	7
2000 mm with hook*	6

*one ring included

COLOUR TEMPERATURE

2700K	4
3000K	5
tunable white 2200 – 4000K*	

*DALI-2 DT8

CONTROL

non DIM	1
DALI-2	3

MATERIAL COLOUR

chrome	4
traffic white RAL 9016	7
jet black RAL 9005	8
special colours p. 992	X

ACCESSORY COLOUR

traffic white RAL 9016	7
jet black RAL 9005	8

BEAM ANGLE

medium 25°	M
flood 44°	F

Options on request

COLOUR TEMPERATURE

4000K	
-------	--

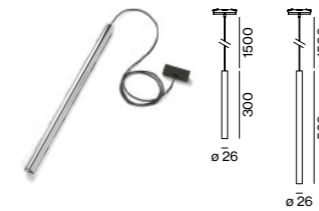

TULA nano suspended

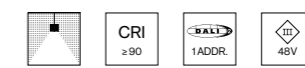

DOWNLIGHT

INSET POWER	COLOUR TEMP.	LUMINOUS FLUX	ORDER CODE
11W	2700K	642lm	050-L 8 1 1 :: ▣ ▣ ▲
	3000K	688lm	

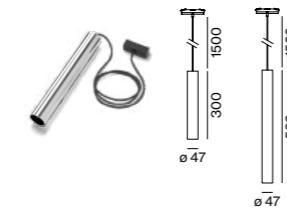

TULA micro suspended

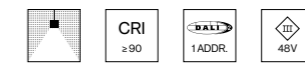

DOWNLIGHT

INSET POWER	COLOUR TEMP.	LUMINOUS FLUX	ORDER CODE
14W	2700K	998lm	050-L 8 1 5 :: ▣ ▣ ▲
	3000K	1048lm	
5.4W	2200 – 4000K	254lm	050-L 8 1 5 D 3 ▣ ▲

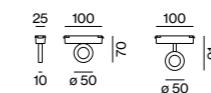

Mounting accessories

RING track mounted

TYPE	Ø-H (mm)	ORDER CODE
MOVE IT 25 S	50-70	050-151011 ▣
MOVE IT 25	50-91	050-051011 ▣



RING ceiling mounted

TYPE	Ø-H (mm)	ORDER CODE
MOVE IT 25S/25	50-88	050-051021 ▣

TULA
 decorative inset 25/25S

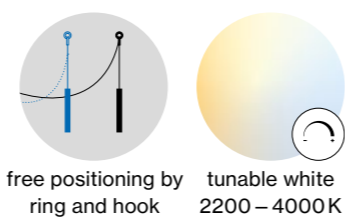

LUMINOUS FLUX value calculated for CRI ≥ 90, colour white, lens flood

Mape kitchen & interior Putte, BE**Private Residence** Århus, DK –
by Friis Moltke Architects with
lighting design by anker & co



Private Residence Linz, AT –
by ARKD, architekturbüro arkade
zt gmbh including lighting design



← back

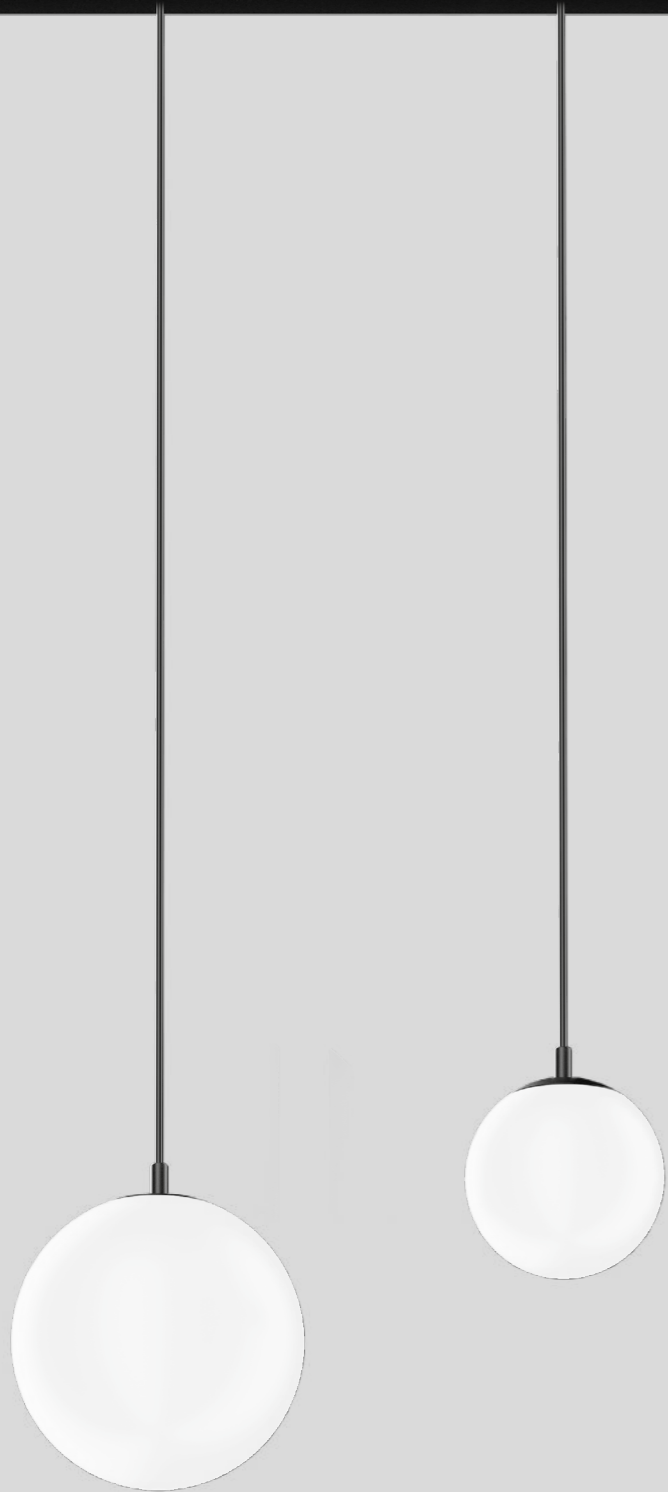

Quickinfo

2700 K, 3000 K
 CRI ≥ 90, 3 SDCM
 up to 55 lm/W
 L80 @ 50 000 h
 non DIM, DALI-2
 IP 40

Types

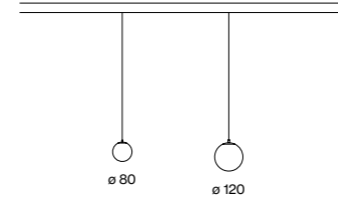

Colours



Light distribution



Order options

CABLE SUSPENSION

1500 mm	5
2000 mm with hook*	6

*one ring included

COLOUR TEMPERATURE

2700 K	4
3000 K	5

CONTROL

non DIM	1
DALI-2	3

MATERIAL COLOUR

○ pure white RAL 9010	7
● jet black RAL 9005	8
🌈 special colours p.992	X

ACCESSORY COLOUR

○ pure white RAL 9010	7
● jet black RAL 9005	8

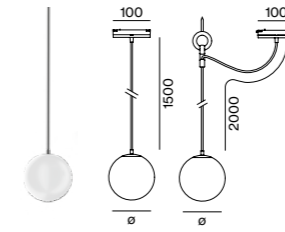

PAL suspended



DOWNLIGHT

INS. POWER	COLOUR TEMP.	LUM. FLUX	Ø (mm)	ORDER CODE
9.1W	2700 K	472lm	80	050-1 11 11
	3000 K	498lm		
9.1W	2700 K	472lm	120	050-1 13 13
	3000 K	498lm		

Mounting accessories

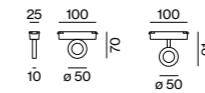

RING track mounted

TYPE	Ø-H (mm)	ORDER CODE
MOVE IT 25 S	50-70	050-151011
MOVE IT 25	50-91	050-051011



RING ceiling mounted

TYPE	Ø-H (mm)	ORDER CODE
MOVE IT 25S/25	50-88	050-051021

INSET POWER in watts is the current consumption excluding any ballast
LUMINOUS FLUX value calculated for CRI ≥ 90, colour white, glass

Restaurant
Visualisation



← back



wästberg w201 Extra small pendant

Design by Claesson Koivisto Rune

Quickinfo

2700 K
CRI ≥ 95, 3 SDCM
up to 97lm/W
L90 @ 50 000h
non DIM, DALI-2

Types

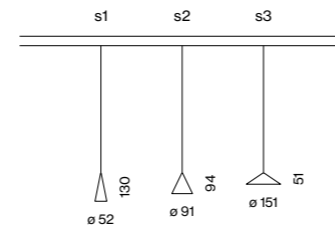

Colours



Order options

CABLE SUSPENSION	<input checked="" type="checkbox"/>
3000mm	5
3000mm with hook	6

COLOUR TEMPERATURE	
2700K	

CONTROL	<input checked="" type="checkbox"/>
non DIM	1
DALI-2	3

MATERIAL COLOUR	<input checked="" type="checkbox"/>
○ traffic white RAL 9016	7
● jet black RAL 9005	8

ACCESSORY COLOUR	<input checked="" type="checkbox"/>
○ pure white RAL 9010	7
● jet black RAL 9005	8

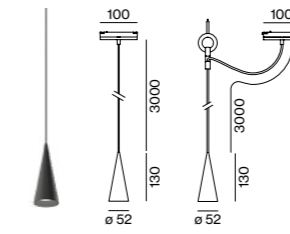

w201 Extra small pendant s1



DOWNLIGHT				
INSET POWER	COLOUR TEMP.	LUMINOUS FLUX	ORDER CODE	
6W	2700K	445lm	050-04814	

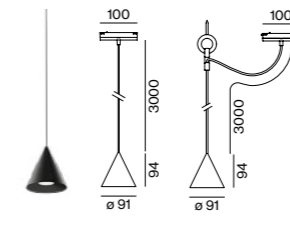

w201 Extra small pendant s2



DOWNLIGHT				
INSET POWER	COLOUR TEMP.	LUMINOUS FLUX	ORDER CODE	
6W	2700K	509lm	050-04824	

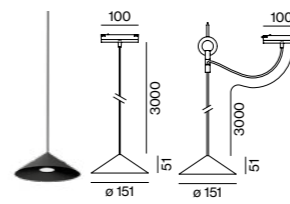

w201 Extra small pendant s3



DOWNLIGHT				
INSET POWER	COLOUR TEMP.	LUMINOUS FLUX	ORDER CODE	
6W	2700K	579lm	050-04834	

Mounting accessories

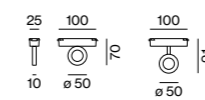

RING track mounted			
TYPE	Ø-H (mm)	ORDER CODE	
MOVE IT 25 S	50-70	050-151011	
MOVE IT 25	50-91	050-051011	



RING ceiling mounted			
TYPE	Ø-H (mm)	ORDER CODE	
MOVE IT 25S/25	50-88	050-051021	

INSET POWER in watts is the current consumption excluding any ballast
LUMINOUS FLUX value calculated for CRI ≥ 95, colour white

← back

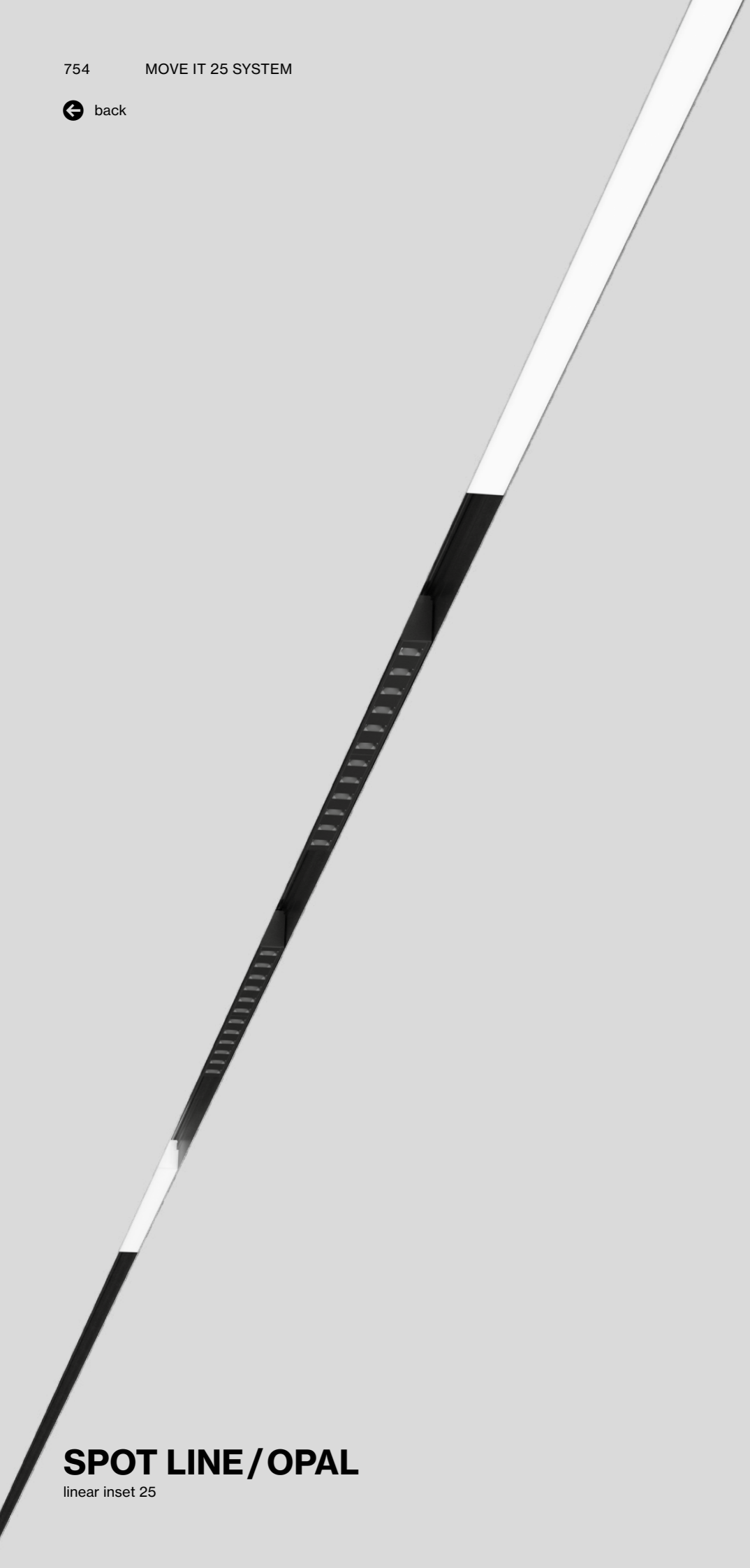

SPOT LINE / OPAL

linear inset 25

Quickinfo

2700K, 3000K, TW (opal)
 CRI ≥ 90, 3 SDCM
 SPOT LINE up to 80 lm/W
 OPAL up to 109 lm/W
 L80 @ 50 000 h
 non DIM, DALI-2

Types

MOVE IT 25

SPOT LINE

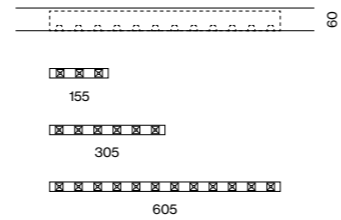

OPAL

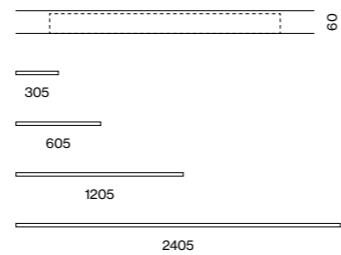

Light distributions

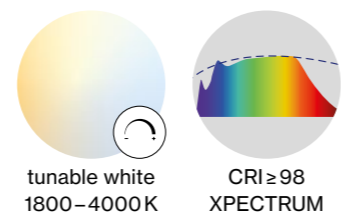
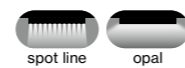

Order options

COLOUR TEMPERATURE	
2700K	4
3000K	5
tunable white 1800-4000K*	L

*only available for opal high performance inset | DALI-2 DT8

CONTROL	
non DIM	1
DALI-2	3

MATERIAL COLOUR

● jet black RAL 9005

Options on request

COLOUR RENDERING INDEX
 CRI ≥ 98 XPECTRUM

COLOUR TEMPERATURE
 4000K

Light distribution

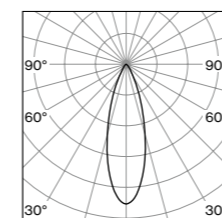

spot line

INSET POWER in watts is the current consumption excluding any ballast
LUMINOUS FLUX value calculated for CRI ≥ 90, colour black

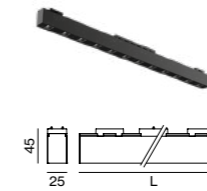

LIGHT INSET 25

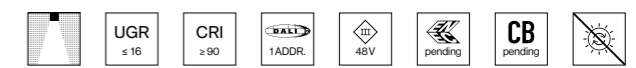

SPOT LINE

INS. POWER	COLOUR TEMP.	LUM. FLUX	L (mm)	ORDER CODE
3 × 1.4 W	2700K	309lm	155	050-0220 :: 8 M
	3000K	336lm		
6 × 1.4 W	2700K	618lm	305	050-0221 :: 8 M
	3000K	672lm		
12 × 1.4 W	2700K	1240lm	605	050-0222 :: 8 M
	3000K	1340lm		

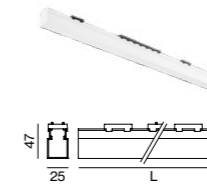

OPAL HIGH PERFORMANCE

INS. POWER	COLOUR TEMP.	LUM. FLUX	L (mm)	ORDER CODE
5 W	2700K	445lm	305	050-0211 :: 8 H
	3000K	477lm		
10 W	2700K	890lm	605	050-0212 :: 8 H
	3000K	954lm		
17 W	2700K	1780lm	1205	050-0214 :: 8 H
	3000K	1910lm		
35 W	2700K	3560lm	2405	050-0218 :: 8 H
	3000K	3820lm		

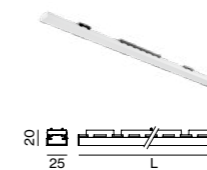

LIGHT INSET 25 S



OPAL HIGH PERFORMANCE

INS. POWER	COLOUR TEMP.	LUM. FLUX	L (mm)	ORDER CODE
5 W	2700K	397lm	305	050-1211 :: 8 H
	3000K	426lm		
10 W	2700K	795lm	605	050-1212 :: 8 H
	3000K	851lm		
17 W	2700K	1590lm	1205	050-1214 :: 8 H
	3000K	1700lm		
35 W	2700K	3180lm	2405	050-1218 :: 8 H
	3000K	3410lm		

canyon solution for MOVE IT 25



Private Residence Sofia, BG –
by Modify studio, Arch Kamelia
Georgieva



ReFuture Clinic Kiev, UA –
by YODEZEEN Architects with lighting
design by Svetlana Osadcha

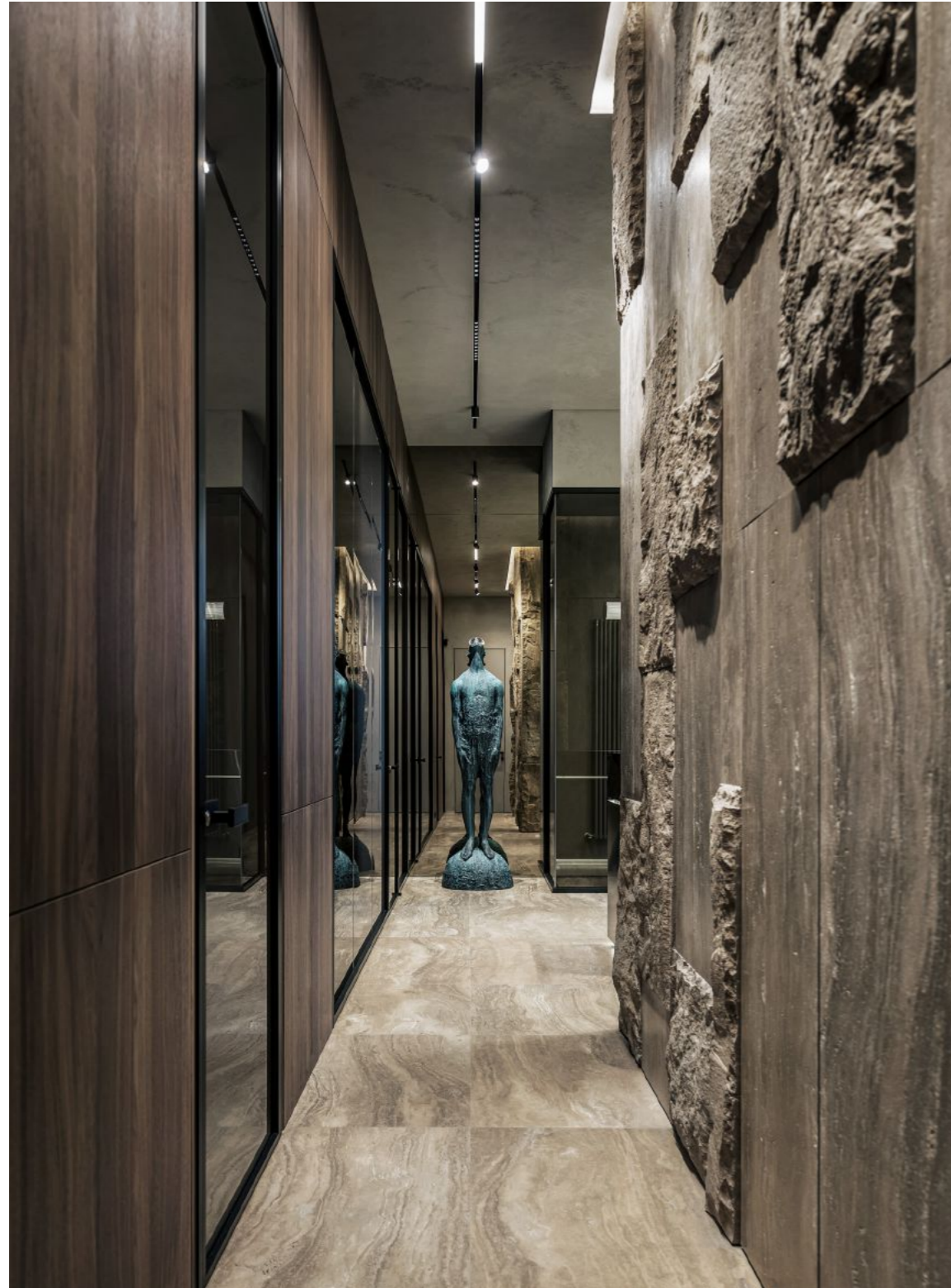

Deansgate Square Manchester, UK –
by Lister & Lister with lighting design
by Troup, Bywaters & Anders Lighting

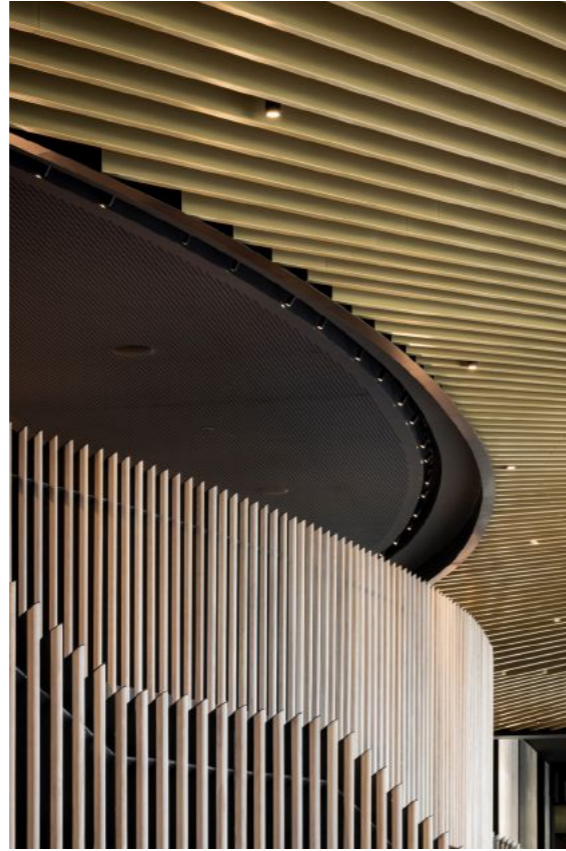

Aertssen Group
Beveren, BE –
by Mertens Architecten



← back



WALLWASHER

linear inset 25/25 S

Quickinfo

2700 K, 3000 K
 CRI ≥ 90, 3 SDCM
 WALLWASHER up to 81lm/W
 WW flush up to 77lm/W
 L80 @ 50 000 h
 non DIM, DALI-2

Types

MOVE IT 25

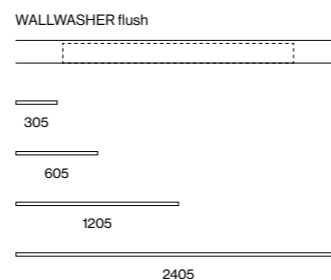
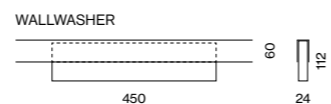

MOVE IT 25 S

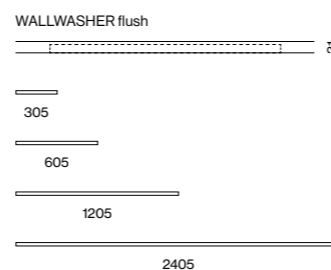

Light distribution



Order options

COLOUR TEMPERATURE	
2700K	4
3000K	5

CONTROL	
non DIM	1
DALI-2	3

MATERIAL COLOUR

● jet black RAL 9005

Options on request

COLOUR RENDERING INDEX
 CRI ≥ 98 XPECTRUM

COLOUR TEMPERATURE
 4000K

Light distributions

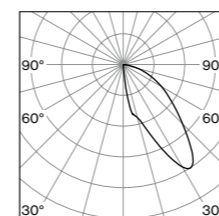

wallwasher

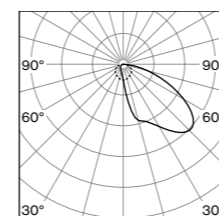

wallwasher flush

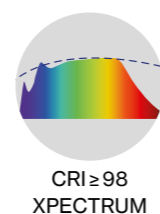

INSET POWER in watts is the current consumption excluding any ballast
LUMINOUS FLUX value calculated for CRI ≥ 90, colour black



LIGHT INSET 25

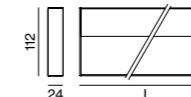
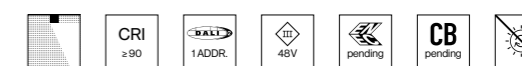

WALLWASHER

INS. POWER	COLOUR TEMP.	LUM. FLUX	L (mm)	ORDER CODE
13 W	2700 K	983 lm	450	0 50-0 2 3 2 :: 3 8 A
	3000 K	1050 lm		

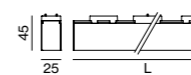
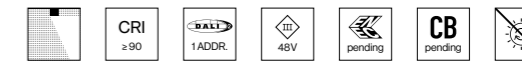

WALLWASHER FLUSH

INS. POWER	COLOUR TEMP.	LUM. FLUX	L (mm)	ORDER CODE
5 W	2700 K	329 lm	305	0 50-0 2 1 1 :: 8 A
	3000 K	367 lm		
11 W	2700 K	658 lm	605	0 50-0 2 1 2 :: 8 A
	3000 K	735 lm		
19 W	2700 K	1320 lm	1205	0 50-0 2 1 4 :: 8 A
	3000 K	1470 lm		
38 W	2700 K	2630 lm	2405	0 50-0 2 1 8 :: 8 A
	3000 K	2940 lm		

Optical accessories

ANTI-GLARE GRID

TYPE	L-W (mm)	ORDER CODE
WALLWASHER FLUSH	303-25	0 50-0 2 3 0 9 1 8

cluster solution to create anti-glare grid for all lengths



LIGHT INSET 25 S

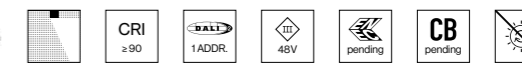

WALLWASHER FLUSH

INS. POWER	COLOUR TEMP.	LUM. FLUX	L (mm)	ORDER CODE
5 W	2700 K	329 lm	305	0 50-1 2 1 1 :: 8 A
	3000 K	367 lm		
11 W	2700 K	658 lm	605	0 50-1 2 1 2 :: 8 A
	3000 K	735 lm		
19 W	2700 K	1320 lm	1205	0 50-1 2 1 4 :: 8 A
	3000 K	1470 lm		
38 W	2700 K	2630 lm	2405	0 50-1 2 1 8 :: 8 A
	3000 K	2940 lm		

Jewelery + Optical Store

Ludwigsburg, DE –

by Ippolito FleitzGroup – Identity Architects



← back



WALL GRAZER/BATWING

linear inset 25S

Quickinfo

2700 K, 3000 K
 CRI ≥ 90, 3 SDCM
 WALL GRAZER up to 127lm/W
 BATWING up to 124lm/W
 L80 @ 50 000h
 non DIM, DALI-2

Types

MOVE IT 25 S

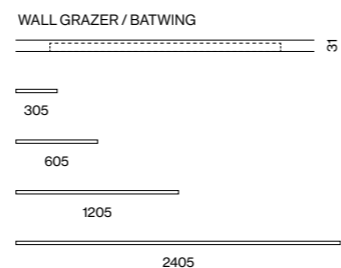

Light distributions

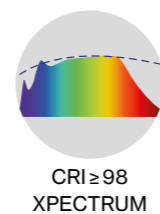

Order options

COLOUR TEMPERATURE	
2700 K	4
3000 K	5

CONTROL	
non DIM	1
DALI-2	3

MATERIAL COLOUR	
● jet black RAL 9005	

Options on request

COLOUR RENDERING INDEX	
CRI ≥ 98 XPECTRUM	

COLOUR TEMPERATURE	
4000 K	

Light distributions

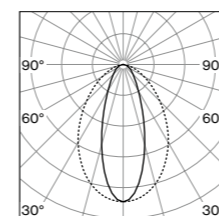

wall grazer

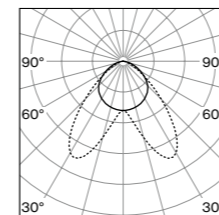

batwing

INSET POWER in watts is the current consumption excluding any ballast
LUMINOUS FLUX value calculated for CRI ≥ 90, colour black

LIGHT INSET 25 S

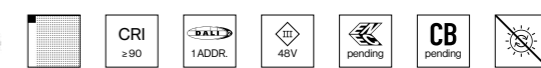
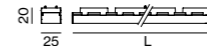

WALL GRAZER					
INS. POWER	COLOUR TEMP.	LUM. FLUX	L (mm)	ORDER CODE	
5 W	2700 K	518 lm	305	0 5 0 - 1 2 1 1 :: ⇨ 8 S	
	3000 K	555 lm			
10 W	2700 K	1040 lm	605	0 5 0 - 1 2 1 2 :: ⇨ 8 S	
	3000 K	1110 lm			
17 W	2700 K	2070 lm	1205	0 5 0 - 1 2 1 4 :: ⇨ 8 S	
	3000 K	2220 lm			
35 W	2700 K	4150 lm	2405	0 5 0 - 1 2 1 8 :: ⇨ 8 S	
	3000 K	4440 lm			

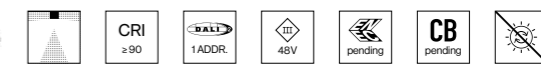
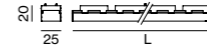

BATWING					
INS. POWER	COLOUR TEMP.	LUM. FLUX	L (mm)	ORDER CODE	
5 W	2700 K	506 lm	305	0 5 0 - 1 2 1 1 :: ⇨ 8 B	
	3000 K	542 lm			
10 W	2700 K	1010 lm	605	0 5 0 - 1 2 1 2 :: ⇨ 8 B	
	3000 K	1080 lm			
17 W	2700 K	2020 lm	1205	0 5 0 - 1 2 1 4 :: ⇨ 8 B	
	3000 K	2170 lm			
35 W	2700 K	4040 lm	2405	0 5 0 - 1 2 1 8 :: ⇨ 8 B	
	3000 K	4330 lm			

**Dental Practice Coornaert -
Tandartscentrum Atlas**
Kortrijk, BE – by Maison Jane

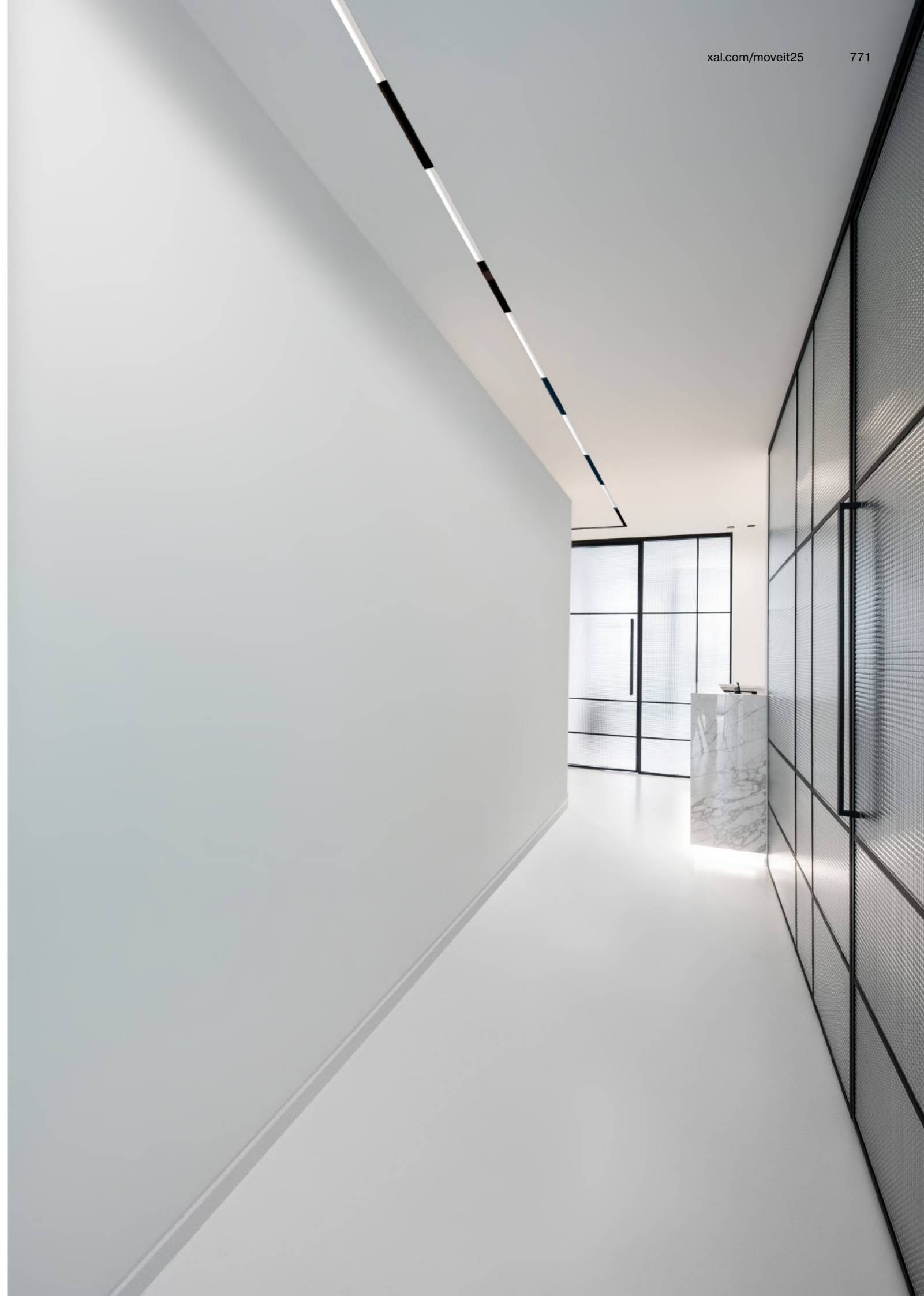

Quickinfo

PET felt
 ♻️ from recycled material
 up to absorption class A

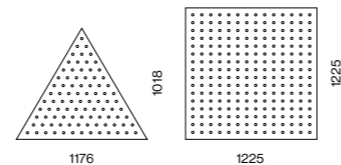
Types**Colours****Order options****MATERIAL COLOUR**

white W
 black L

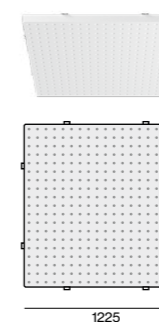
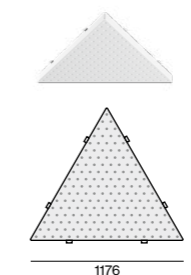
**MOVE IT 25 suspended****MOVE IT ACOUSTIC TRIANGLE**

TYPE	L-W-H (mm)	ORDER CODE
1200 inlay MOVE IT system*	1176-1018-57	050-230122

*NODE connector + track 1220mm

MOVE IT ACOUSTIC SQUARE

TYPE	L-W-H (mm)	ORDER CODE
1200 inlay MOVE IT system*	1225-1225-57	050-230222

*NODE connector + track 1220mm

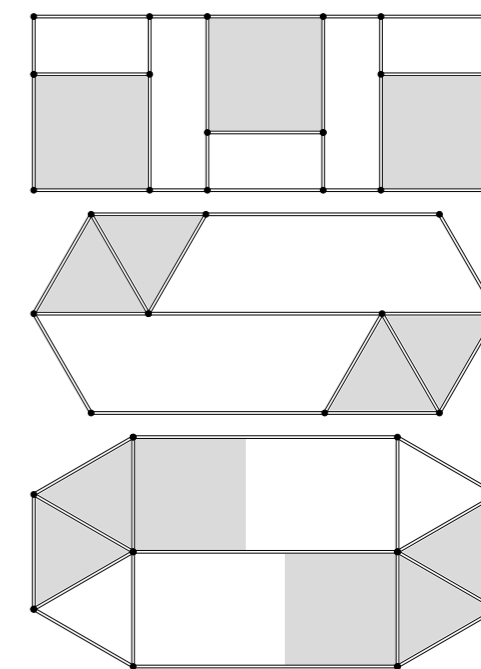
ACOUSTIC EXAMPLES**ACOUSTIC elements**

inlay 25

EN Highly effective acoustic element made of self-supporting, recycled PET felt; direct sound is absorbed by the front-mounted fleece, sound reflected from the ceiling by an additional, rear-mounted fleece; this creates high acoustic performance; for installation in the MOVE IT 25 suspended system composed of node connectors and 1220 mm profiles

ES Elemento acústico de alta eficacia fabricado de fieltro PET reciclado y autoportante; absorción del ruido directo por el vellón delantero, así como absorción del ruido reflejado por el techo mediante un vellón adicional trasero; con ello gran rendimiento acústico; para la integración en el sistema suspendido MOVE IT 25, compuesto de uniones y perfiles de 1220 mm de largo

has-to-be gmbH
Radstadt, AT



FlexOffice, Meseturm Basel
Basel, CH



Office on track

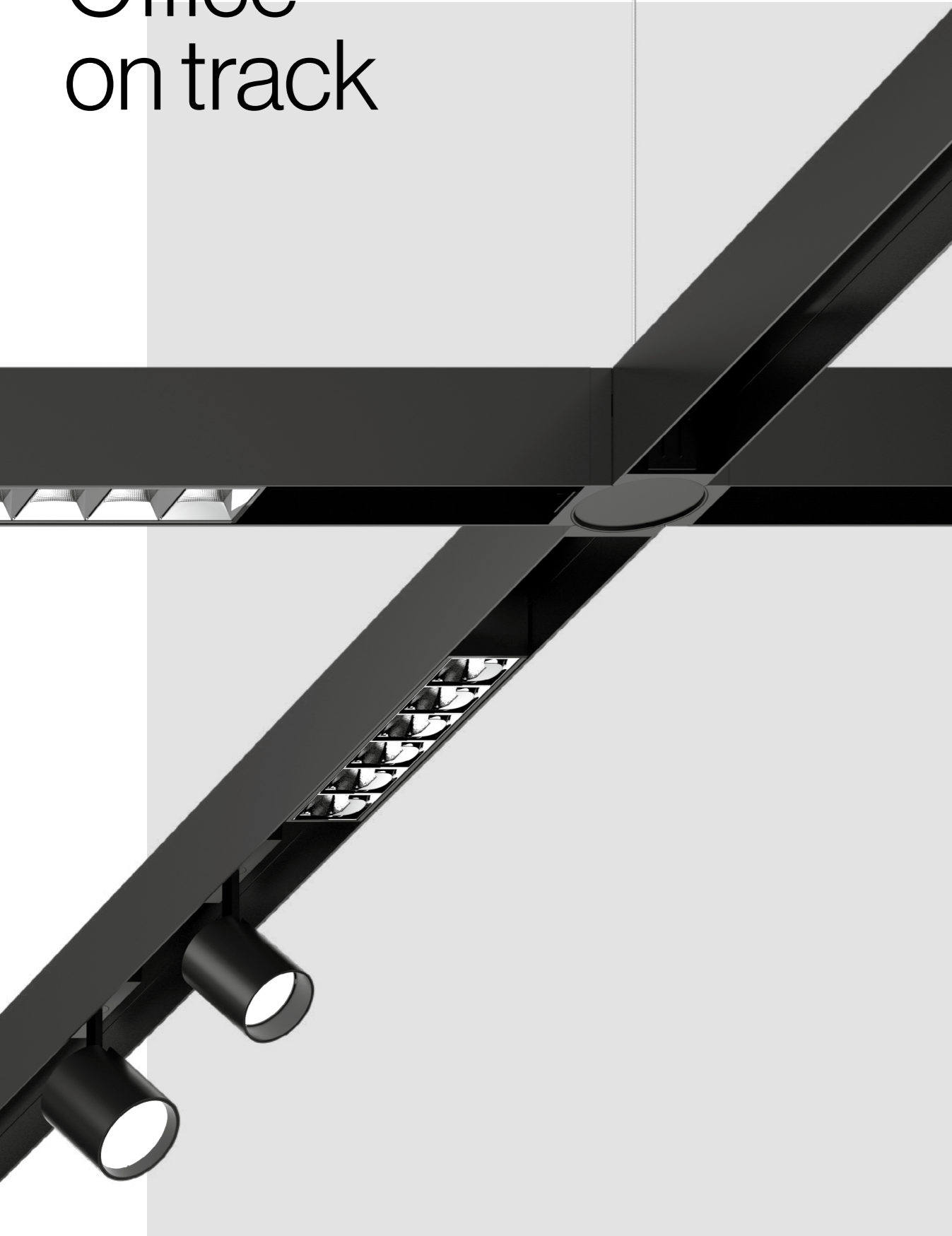

MOVE IT 45 system

EN MOVE IT 45 offers glare-free office lighting with the flexibility of a track system. It is available as a suspended version, or as a recessed or surface-mounted variant for wall or ceiling mounting. Indirect light for homogeneous ceiling illumination is available as an option. The profiles are connected using corner elements or NODE connectors. Spotlights, linear office insets, and decorative luminaires are installed in the system without tools and can be flexibly adapted to changes in the room. With just one track system and the appropriate insets, completely different areas in the office – such as workstations, meeting rooms, and corridors – can be individually illuminated and controlled. Square acoustic elements that can be optionally integrated additionally create balanced room acoustics.

ES Iluminación de oficina libre de deslumbramientos, tan flexible como un sistema de carril: MOVE IT 45 está disponible en variantes empotradas o de superficie para el montaje en pared o techo y también como versión suspendida, dotadas opcionalmente con una proporción de luz indirecta para una iluminación homogénea del techo. Los perfiles se unen entre sí mediante conectores NODE. Proyector, elementos de oficina lineales y luminarias decorativas pueden montarse en el sistema sin necesidad de herramientas y adaptarse con flexibilidad a las modificaciones del espacio. Con un solo sistema de carril y los elementos adecuados es posible iluminar y controlar diversas zonas de la oficina –tales como los puestos de trabajo, las salas de reunión y los pasillos– de un modo totalmente individualizado. Unos elementos acústicos cuadrados de integración opcional generan además una acústica ambiental equilibrada.

Type



45

Mountings

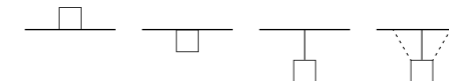
trimless
recessed

ceiling

suspended

indirect
suspended

Configurations



linear

corner

node

Light distributions

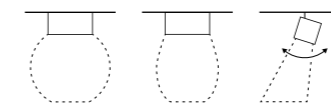

opal

reflector
(UGR ≤ 19)

spotlight

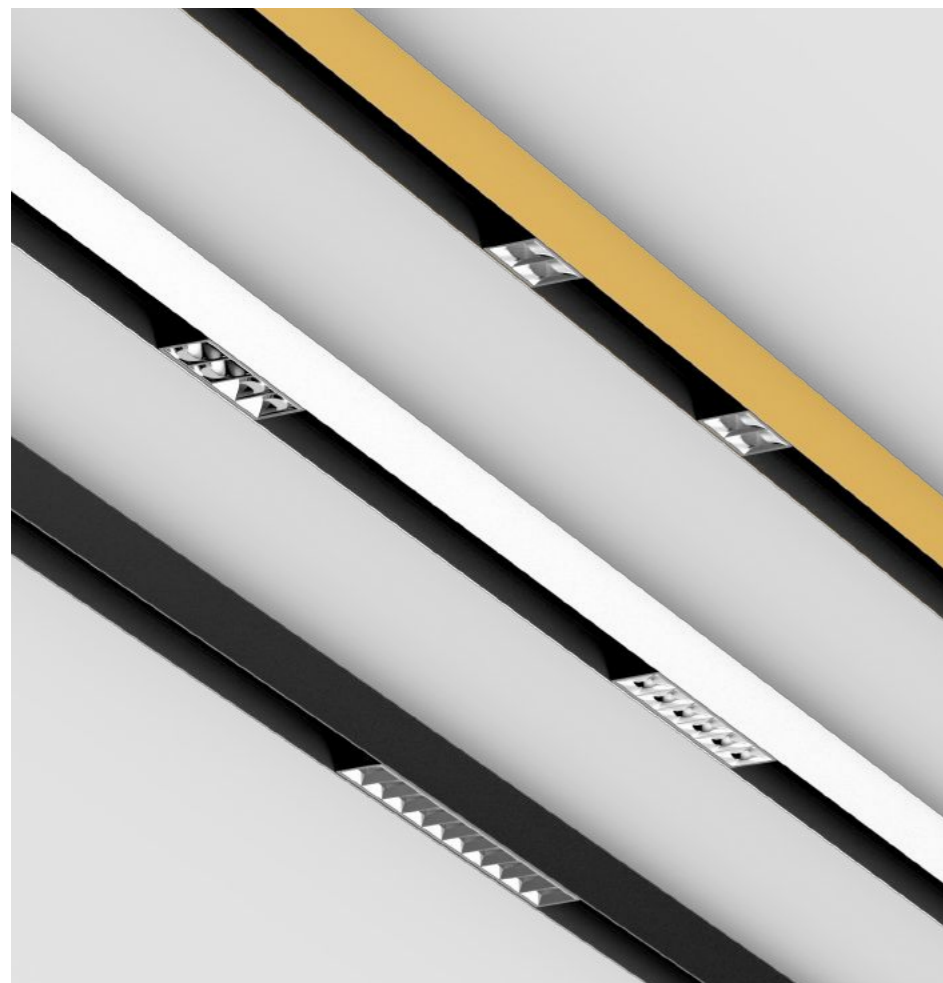

Colour variety

EN MOVE IT profiles are available in various standard colours. Further colour variations are also available, granting your project maximum design freedom. You can learn more about our colour palette at xal.com/colours.

ES Los perfiles MOVE IT están disponibles en diversos colores estándar. Además existen otras variantes de color disponibles, lo que le proporciona la máxima libertad de diseño para su proyecto. Hallará más información sobre nuestra paleta de colores en xal.com/colours.



xal.com/colours

Individual grids & room acoustics

EN The NODE Connector lets you create different ceiling patterns from up to four MOVE IT 45 profiles per node. Create attractive geometric shapes by connecting the profiles at a 90° angle. Special corner connectors that are rotated 35° to the left and right provide even more design freedom. Simply extend the MOVE IT Suspended System with square acoustic elements for optimised room acoustics.

ES NODE Connector le permite crear distintos patrones de techo con hasta cuatro perfiles MOVE IT 45 por nodo. Conectando los perfiles en un ángulo de 90° se obtienen atractivas formas geométricas. Para una mayor libertad de diseño pueden utilizarse conectores de esquinas especiales que pueden girarse 35° a izquierda y a derecha. Para una mayor optimización de la acústica ambiental, el sistema MOVE IT Suspended puede ampliarse sencillamente con elementos acústicos cuadrados.



Mounting options

EN The elegant MOVE IT 45 System offers a wide variety of installation options: as a trimless recessed or surface-mounted variant for wall or ceiling mounting and suspended. The suspended direct/indirect variant provides additional homogeneous ceiling illumination.

ES El elegante sistema MOVE IT 45 ofrece una gran variedad de posibilidades de montaje, con versiones empotradas y de superficie sin marco para el montaje en pared o techo y otra de suspensión. La versión de suspensión Direct/Indirect garantiza una iluminación homogénea adicional del techo.

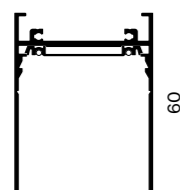

45

XPECTRUM LED

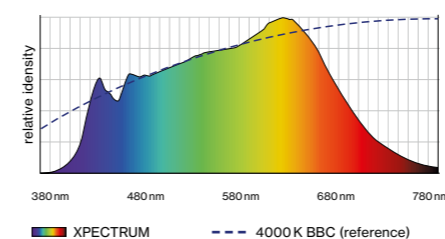

Commercially available LED 4000K

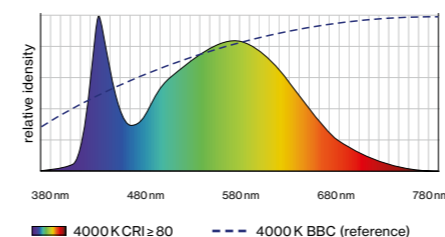

Full-spectrum LED

EN XAL's new XPECTRUM LEDs deliver healthy, biologically effective light. The reduced blue light and increased cyan values reduce the blue light hazard for the eye to daylight-equivalent levels. The resulting non-visual, so-called melanopic light effect, improves concentration and increases sleep quality. The excellent colour rendering of IES TM 30-15 $R_t = 98$ and $R_g = 101$ further helps visual comfort. These LEDs are available for different MOVE IT System insets and indirect insets.

ES El nuevo LED XPECTRUM de XAL ofrece una luz saludable con efectos biológicos. La menor proporción de luz azul y el aumento de los valores de cian minimizan el riesgo de la incidencia de luz azul en el ojo, manteniéndola a un nivel similar al presente en la luz natural. El efecto no visible resultante, denominado efecto melanópico, fomenta la concentración y mejora la calidad del sueño. Además, su excelente reproducción cromática –con índices $R_t = 98$ y $R_g = 101$ según la norma IES TM-30-15– garantiza una mayor comodidad visual. Este LED se encuentra a su disposición para el uso con distintos insertos y elementos de luz indirecta del sistema MOVE IT.

Variety of office reflector insets

EN Office lighting faces various requirements, ranging from standards for workplace lighting ($UGR \leq 19$), homogeneous basic illumination, to spot accentuation. Changing the design or use of office space also requires a flexible lighting solution. MOVE IT 45 responds to this with a wide range of lighting insets that are easily installed and replaced in the track system.

ES La iluminación de oficinas está sometida a requisitos diversos que abarcan desde una iluminación de puestos de trabajo adaptada a la normativa ($UGR \leq 19$) y un alumbrado general homogéneo, hasta la acentuación mediante proyectores. Las diversas distribuciones o usos de las oficinas también hacen necesaria una solución de iluminación flexible. A esto responde MOVE IT 45 con unos elementos de iluminación variados que pueden montarse en el sistema de carriles y sustituirse fácilmente.



Control options

EN MOVE IT Insets are available with DALI-2 and can be controlled individually. Configuration and control are simply done via DALI. As the open DALI communication standard is fully supported, all compatible luminaires can be easily integrated into the system. The Wireless-to-DALI Inset enables wireless control of DALI luminaire systems by using a communication module.

ES Los insertos MOVE IT están disponibles con DALI-2 y pueden controlarse individualmente. La configuración y el control se efectúan fácilmente a través de DALI. Ya que el sistema admite totalmente el uso del estándar de comunicación abierto DALI, todas las luminarias compatibles pueden integrarse en él con facilidad. El inserto "Wireless to DALI" posibilita el control sin cable de sistemas de luminarias DALI utilizando un módulo de comunicación.

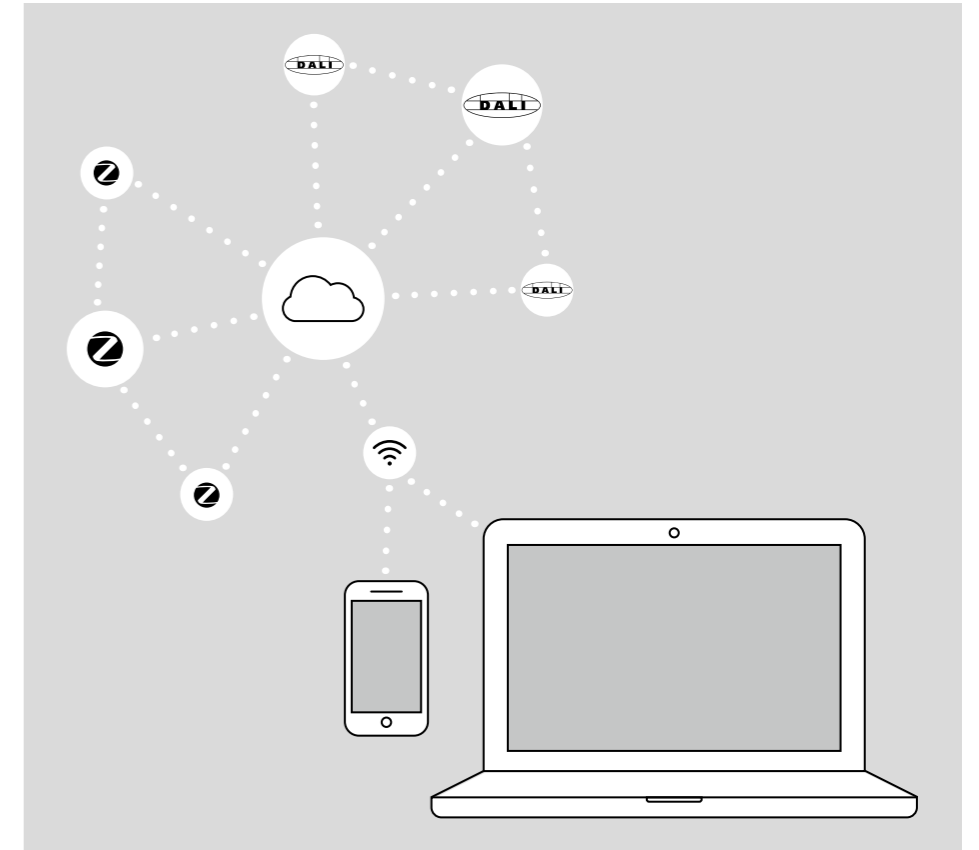

Light optics

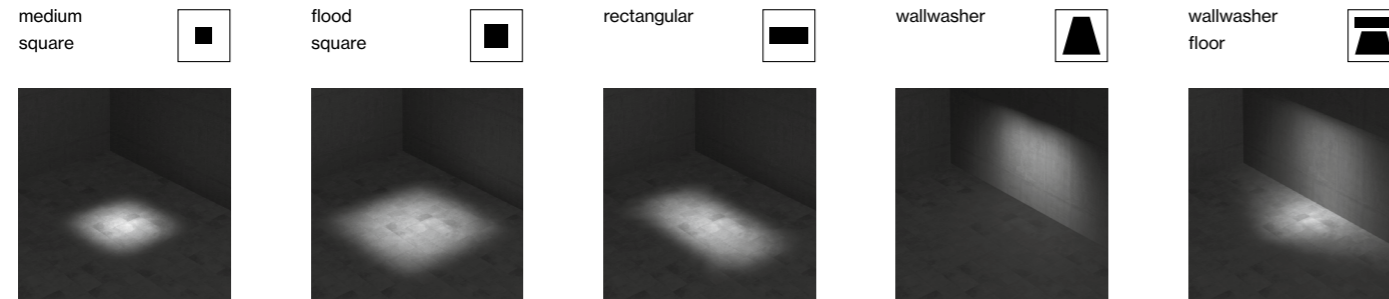

Inset variety

L1 Applications



L2 Applications



L24 OFFICE $UGR \leq 19$



L4 Applications



L6 Applications



L10 OFFICE $UGR \leq 19$



OPAL



IoT ready

EN IoT ready refers to the possibility of equipping luminaires with smart sensor technology. You receive valuable information, such as your lighting system's energy consumption or your rooms' utilisation over the day. You can set shut-off delay times and brightness values or plan time-controlled light sequences. The sensor is magnetically inserted into the track system like a spotlight and can be individually configured without restriction by existing standards.

ES "IoT ready" indica la posibilidad de equipar a las luminarias con sensores inteligentes. Esto le permitirá obtener información valiosa, tal como el consumo de energía de su sistema de iluminación o el grado de utilización de las salas en el transcurso del día. También es posible establecer tiempos de desconexión y valores de luminosidad, así como programar transiciones luminosas reguladas por temporizador. El sensor se fija magnéticamente al sistema de carriles como un foco, y puede configurarse de forma totalmente individual sin ningún tipo de restricciones por estándares existentes.

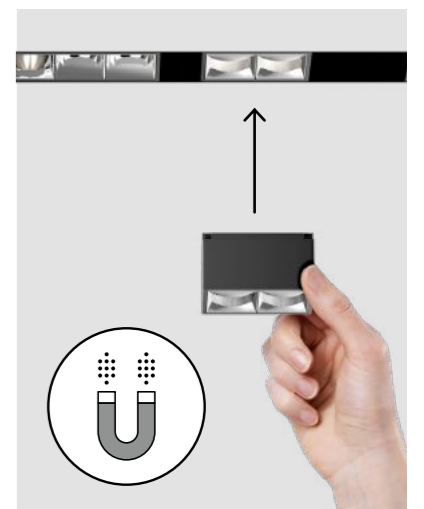
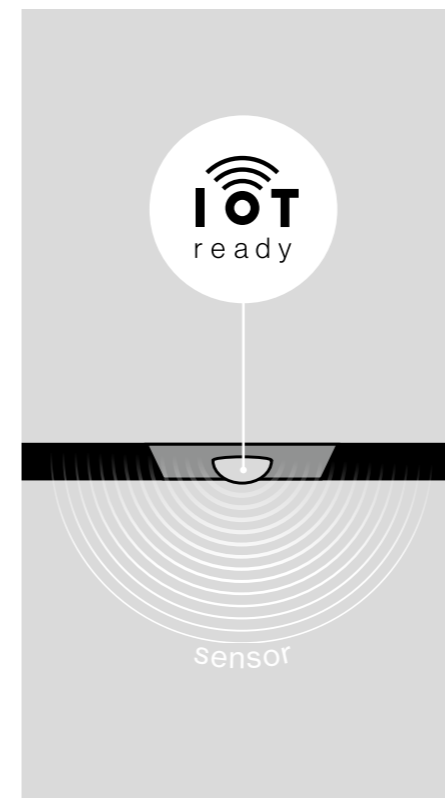

Magnetic attachment

EN MOVE IT Insets are mounted without tools and magnetically fixed within the profile. They can, therefore, be adjusted and adapted according to the lighting requirements with just one movement.

ES Los elementos en el MOVE IT se montan sin herramientas y se fijan magnéticamente en el interior del perfil. Esto les permite ajustarse y adaptarse con total facilidad según los requisitos de la iluminación.



MOVE IT 45 system

trimless / surface / suspended

EN Extruded aluminium profile with 45 mm width groove; for trimless installation in plasterboard ceilings (wall or ceiling mounting) with 12.5 mm ceiling thickness; or for wall-/ceiling surface mounting or suspended mounting (cable suspension, height adjustment without tools, incl. black feed); optional with indirect light component for additional accentuation of the ceiling; for lighting systems, 90° angle connectors for flexible system design; node connectors, up to 4 profile connection options; with power track profile for take off of supply voltage and DALI signal; surf. anod. or powder coated; insets can be installed flexibly and without tools by means of magnetic holders + locking; sound absorbing accessories available

ES Perfil de alum. extruido con ancho de junta de 45 mm; para encastrar sin bordes en placas de yeso laminado (montaje pared o techo) de 12,5 mm de espesor; o para montaje en pared/techo o suspendido (suspensión por cable, ajuste de altura sin herramienta, cable de alim. negro incluido); componentes de luz indir. opcionales para realce adicional del techo; para sistemas de iluminación, conect. angul. de 90° para la configur. flexible del sistema; conector de nodos, conex. de hasta 4 perfiles; con perfil de carril electrif. para toma de suministro eléct. y señal DALI; superficie anodiz. o recub. de pintura en polvo; montaje flexible y sin herra. de los elem. de luz mediante un soporte magnético con bloqueo; accesorios absorb. del ruido disponibles

Quickinfo

3000K
CRI ≥ 90, 2 SDCM
up to 117 lm/W
L80 @ 50 000 h
non DIM, DALI-2

Types

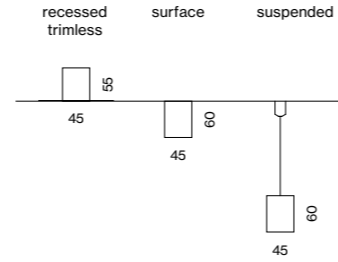

connectors

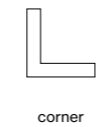
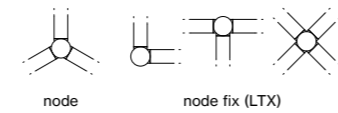

Colours



Order options

CONTROL	
non DIM	1
DALI-2	3

MATERIAL COLOUR

● jet black RAL 9005

Options on request

CONNECTOR

T-connector
X-connector

INSTALLATION TRACK

acoustic soft ceilings



MOVE IT 45 trimless



INSTALLATION TRACK

L (mm)		ORDER CODE
617	channel	050-72320-8
1217	channel	050-72340-8
2417	channel	050-72380-8
3622	channel	050-72390-8
cust. cut	channel (non DIM)	E83551-8
cust. cut	channel (DALI-2)	E83521-8
692x648	channel corner* 90°	050-72310-8
661x661	channel corner* ceiling to wall 90°	050-72311-8

*incl. electrical connector set

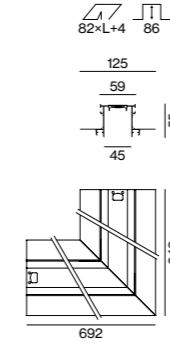

Accessories

END CAPS

TYPE	ORDER CODE
end caps (pair)	050-72300-8

BLIND COVER

L (mm)	ORDER CODE
1217	050-70340-8
2417	050-70380-8
3622	050-70390-8
custom cut	E83500-8B

blind cover can be shortened as desired

CONNECTOR SET

TYPE	ORDER CODE
linear connector (non DIM, DALI-2)	050-20311-30
linear connector flexible	050-20321-0
mechanical linear connector (pair)	050-20111-10

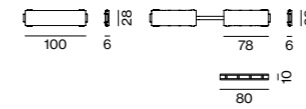

POWER FEEDER UNIT

TYPE	ORDER CODE
non DIM 2 × 2,5 mm ²	050-2020110
DALI-2 2 × 2,5 + 2 × 0,5 mm ²	050-2020130

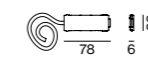

Electrical accessories

see page 788

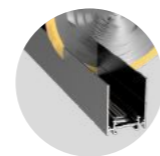

custom cut on building site



acoustic elements (p.806)

back

Order options

CONTROL

non DIM	1
DALI-2	3

MATERIAL COLOUR

○ traffic white RAL 9016	7
● jet black RAL 9005	8

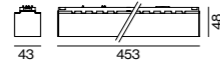

Electrical accessories

POWER SUPPLY INTRACK supply 220-240 V AC, 48 V, 50-60 Hz

TYPE	EFFICIENCY	MOUNTING	L-W-H (mm)	ORDER CODE
150W □ PC II η 92%		intrack	453-43-48	050-2071238
250W □ PC II η 93%		intrack	453-43-48	050-2071338

ENEC approved, incl. feeder cable 2000mm; DALI-2 SELV device integrated

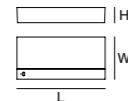

POWER SUPPLY SURFACE supply 220-240 V AC, 48 V, 50-60 Hz

TYPE	EFFICIENCY	MOUNTING	L-W-H (mm)	ORDER CODE
60W □ PC II η 88%		surface	305-144-54	050-20551
100W □ PC II η 92%		surface	455-104-40	050-20554
150W □ PC II η 92%		surface	455-104-40	050-20552
250W □ PC II η 93%		surface	455-104-40	050-20555
320W ⊕ PC I η 94%		surface	305-144-54	050-20553

ENEC approved, incl. feeder cable 2000mm; DALI-2 SELV device integrated

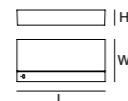

POWER SUPPLY EXTERNAL supply 220-240 V AC, 48 V, 50-60 Hz

TYPE	EFFICIENCY	MOUNTING	L-W-H (mm)	ORDER CODE
60W □ PC II η 88%		external	163-43-32	002-62133
100W □ PC II η 92%		external	350-30-18	002-62134
150W □ PC II η 92%		external	350-30-18	002-62135
250W □ PC II η 93%		external	400-40-22	002-62139
320W ⊕ PC I η 94%		external	252-90-44	002-60320

ENEC approved, incl. feeder cable 2000mm

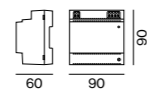

DIN RAIL POWER SUPPLY BASIC 48V
220-240V | 50-60Hz | □ PC II | MTBF @ 55° ambient temperature

TYPE	EFFICIENCY / MTBF	W-H-D (mm)	ORDER CODE
96W η 89% / >300.000h		90-90-60	005-6520010

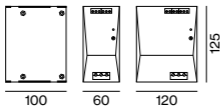

DIN RAIL POWER SUPPLY PRO 48V
220-240V | 50-60Hz | ⊕ PC I | MTBF @ 55° ambient temperature
cascadable max. 5 devices (240 W) or 3 devices (480 W)

TYPE	EFFICIENCY / MTBF	W-H-D (mm)	ORDER CODE
240W η 92% / >400.000h		60-125-100	005-6220110
480W η 93% / >350.000h		120-125-100	005-6220210

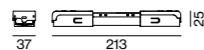

DALI-2 SELV DEVICE

TYPE	L-W-H (mm)	ORDER CODE
control unit	213-37-25	050-2061130

necessary to create DALI-2 SELV signal; DALI power supply integrated



DALI-2 SENSOR

TYPE	L-W-H (mm)	ORDER CODE
ESSENTIAL sensor (brightness & presence)	43-43-48	050-2063378
SENSE sensor (brightness, presence, temperature, sound pressure, humidity, CO ₂)	43-43-48	050-2063278



WIRELESS TO DALI-2 CONTROL DEVICE

TYPE	L-W-H (mm)	ORDER CODE
Zigbee 3.0	111-25-45	050-2065130
Casambi	111-25-45	050-2065230



WIRELESS TO DALI-2 REPEATER

TYPE	L-W-H (mm)	ORDER CODE
Zigbee 3.0	111-25-45	050-2066130
Casambi	111-25-45	050-2066230

DALI-2 SELV device required

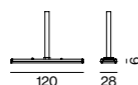

MIDDLE FEED

TYPE	ORDER CODE
non DIM 2×2,5mm ²	050-2038110
DALI-2 2×2,5 + 2×0,5mm ²	050-2038130

cable length 2000mm



← back



LIGHT INSET 45

linear inset 45

Quickinfo

3000K, 4000K, TW
 CRI ≥ 90, 3 SDCM
 DALI-2

L85 @ 50 000 h
 opal / opal jut-out up to 99 lm/W
 microprism. (≤ 19) up to 88 lm/W
 microprism. (≤ 22) up to 78 lm/W

L80 @ 50 000 h
 UGR ≤ 19 / 65° ≤ 1500 cd/m²
 L1 up to 106 lm/W
 L2 up to 97 lm/W
 L4 up to 104 lm/W
 L6 up to 90 lm/W

L90 @ 50 000 h
 UGR ≤ 19 / 65° ≤ 1500 cd/m²
 L10 office up to 102 lm/W
 L24 office up to 120 lm/W

Types

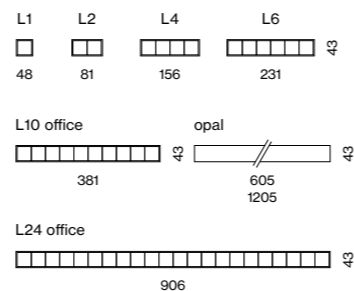

Colour



Light distributions

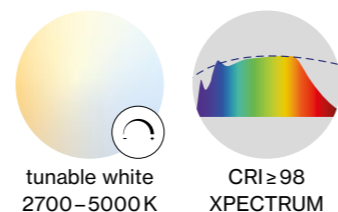

Order options

COLOUR TEMPERATURE	
3000K	5
4000K	6
tunable white 2700-5000K*	D

*DALI-2 DT8

CONTROL

DALI-2

MATERIAL COLOUR

● jet black RAL 9005

Options on request

COLOUR RENDERING INDEX
 CRI ≥ 98 XPECTRUM

CONTROL

Zigbee 3.0

LIGHT INSET 45

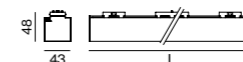

OPAL HIGH PERFORMANCE

INSET POWER	COLOUR TEMP.	LUM. FLUX	L (mm)	ORDER CODE
12W	3000K	1120lm	605	0 5 0 - 3 2 1 2 :: 38H
24W	3000K	2240lm	1205	0 5 0 - 3 2 1 4 :: 38H
	4000K	1190lm		
	4000K	2380lm		

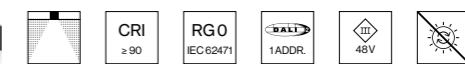
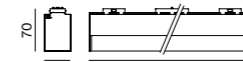

OPAL JUT-OUT

INSET POWER	COLOUR TEMP.	LUM. FLUX	L (mm)	ORDER CODE
12W	3000K	1120lm	605	0 5 0 - 3 2 1 2 :: 38J
24W	3000K	2240lm	1205	0 5 0 - 3 2 1 4 :: 38J
	4000K	1190lm		
	4000K	2380lm		

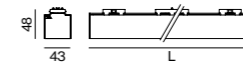

MICROPRISMATIC UGR ≤ 19

INSET POWER	COLOUR TEMP.	LUM. FLUX	L (mm)	ORDER CODE
9.9W	3000K	704lm	605	0 5 0 - 3 2 1 2 :: 38P
17W	3000K	1410lm	1205	0 5 0 - 3 2 1 4 :: 38P
	4000K	751lm		
	4000K	1500lm		

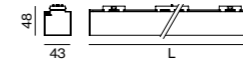

MICROPRISMATIC UGR ≤ 22

INSET POWER	COLOUR TEMP.	LUM. FLUX	L (mm)	ORDER CODE
23W	3000K	1640lm	605	0 5 0 - 3 2 4 2 :: 38P
45W	3000K	3280lm	1205	0 5 0 - 3 2 4 4 :: 38P
	4000K	1750lm		
	4000K	3500lm		

INSET POWER in watts is the current consumption excluding any ballast
 LUMINOUS FLUX value calculated for CRI ≥ 90, colour black

[back](#)

Order options

COLOUR TEMPERATURE

3000K	5
4000K	6
tunable white 2700-5000K*	D

*DALI-2 DT8

CONTROL

DALI-2

LIGHT OPTIC

medium square (UGR ≤ 10)	E
flood square (UGR ≤ 19)	F

LIGHT OPTIC COLOUR

chrome reflector	O
black reflector*	B

*not available for spot round, narrow medium round and wallwasher

MATERIAL COLOUR

● jet black RAL 9005

Options on request

LIGHT OPTIC

spot round	
narrow medium round	
medium round (UGR ≤ 19)	
medium square (UGR ≤ 10)	
flood round (UGR ≤ 19)	
flood square (UGR ≤ 19)	
wide flood round	
wide flood square	
rectangular	
wallwasher	
wallwasher floor	

LIGHT OPTIC COLOUR

gold reflector

Planning information

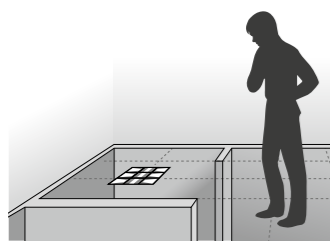

The icons of the light optics are shown in the reflected ceiling plan (RCP) view.

INSET POWER in watts is the current consumption excluding any ballast
LUMINOUS FLUX value calculated for CRI ≥ 90, colour black, reflector chrome

L1 LIGHT INSET

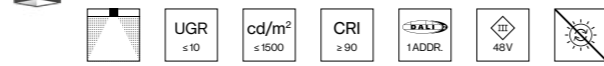

FLOOR

INSET POWER	COLOUR TEMP.	LUMINOUS FLUX	ORDER CODE
3.4 W	3000 K	up to 338 lm	0 9 0 - 9 L 1 :: 3 A B 0 1
	4000 K	up to 361 lm	

choose one light optic ▲ from the options on the left depending on your room needs

L2 LIGHT INSET



WALL
2 × wallwasher

INSET POWER	COLOUR TEMP.	LUMINOUS FLUX	ORDER CODE
6.9 W	3000 K	590 lm	0 9 0 - 9 L 2 :: 3 A B 0 0 1
	4000 K	633 lm	

WALL FLOOR
2 × wallwasher floor

INSET POWER	COLOUR TEMP.	LUMINOUS FLUX	ORDER CODE
6.9 W	3000 K	620 lm	0 9 0 - 9 L 2 :: 3 W B 0 1
	4000 K	662 lm	

CORRIDOR
2 × rectangular

INSET POWER	COLOUR TEMP.	LUMINOUS FLUX	ORDER CODE
6.9 W	3000 K	624 lm	0 9 0 - 9 L 2 :: 3 R B 0 1
	4000 K	667 lm	

L4 LIGHT INSET



FLOOR/CORRIDOR

INSET POWER	COLOUR TEMP.	LUMINOUS FLUX	ORDER CODE
14 W	3000 K	up to 1350 lm	0 9 0 - 9 L 4 :: 3 A B 0 1
	4000 K	up to 1450 lm	

choose one light optic ▲ from the options on the left depending on your room needs

WALL
4 × wallwasher

INSET POWER	COLOUR TEMP.	LUMINOUS FLUX	ORDER CODE
14 W	3000 K	1180 lm	0 9 0 - 9 L 4 :: 3 A B 0 0 1
	4000 K	1270 lm	

WALL
2 × wallwasher 180° + 2 × wallwasher

INSET POWER	COLOUR TEMP.	LUMINOUS FLUX	ORDER CODE
14 W	3000 K	1180 lm	0 9 0 - 9 L 4 :: 3 A B 0 0 2
	4000 K	1270 lm	

WALL FLOOR
4 × wallwasher floor

INSET POWER	COLOUR TEMP.	LUMINOUS FLUX	ORDER CODE
14 W	3000 K	1240 lm	0 9 0 - 9 L 4 :: 3 W B 0 1
	4000 K	1320 lm	

WALL FLOOR
2 × wallwasher floor 180° + 2 × wallwasher floor

INSET POWER	COLOUR TEMP.	LUMINOUS FLUX	ORDER CODE
14 W	3000 K	1240 lm	0 9 0 - 9 L 4 :: 3 W B 0 2
	4000 K	1320 lm	

Order options

COLOUR TEMPERATURE

3000K	5
4000K	6
tunable white 2700-5000K*	D

*DALI-2 DT8

CONTROL

DALI-2

LIGHT OPTIC COLOUR

chrome reflector	O
black reflector*	B

*not available for spot round, narrow medium round and wallwasher

MATERIAL COLOUR

● jet black RAL 9005

Options on request

COLOUR RENDERING INDEX

CRI ≥ 98 XPECTRUM*

*only for L24 light inset

LIGHT OPTIC

spot round	
narrow medium round	
medium round (UGR ≤ 19)	
medium square (UGR ≤ 10)	
flood round (UGR ≤ 19)	
flood square (UGR ≤ 19)	
wide flood round	
wide flood square	
rectangular	
wallwasher	
wallwasher floor	

LIGHT OPTIC COLOUR

gold reflector

INSET POWER in watts is the current consumption excluding any ballast
LUMINOUS FLUX value calculated for CRI ≥ 90, colour black, reflector chrome



L6 LIGHT INSET



WALL
6 × wallwasher

INSET POWER	COLOUR TEMP.	LUMINOUS FLUX	ORDER CODE
21 W	3000 K	1780 lm	0 9 0 - 9 L 6 :: 3 A B 0 0 1
	4000 K	1900 lm	

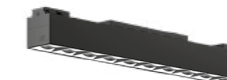

L10 LIGHT INSET

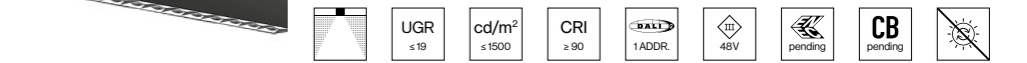

OFFICE UGR ≤ 19
10 × medium square

INSET POWER	COLOUR TEMP.	LUMINOUS FLUX	ORDER CODE
30 W	3000 K	2840 lm	0 5 0 - 3 2 1 1 :: 3 8 0 0 1
	4000 K	3060 lm	



L24 LIGHT INSET

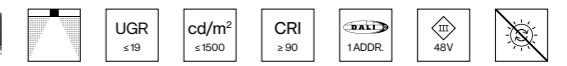

OFFICE UGR ≤ 19
24 × medium square

INSET POWER	COLOUR TEMP.	LUMINOUS FLUX	ORDER CODE
21 W	3000 K	2350 lm	0 5 0 - 3 2 1 3 :: 3 8 R
	4000 K	2510 lm	

SENABStockholm, SE –
by SENAB

Tribünen der Trabrennbahn
Vienna, AT



Press Glass Headquarters
Konopiska, PL – by Konior Studio,
Tomasz Konior



Langzauner GmbH Ried im Innkreis, AT –
by Architektur Mugrauer ZT GmbH with
lighting design by planbox Interior Design GmbH



← back



JUST 45/55

spotlight inset 45

Quickinfo

2700K, 3000K, 4000K, CWD, TW
CRI ≥ 90, 2 SDCM

non DIM, DALI-2

L80 @ 50 000 h
JUST 45 up to 72lm/W

L90 @ 50 000 h
JUST 55 up to 75lm/W

Types

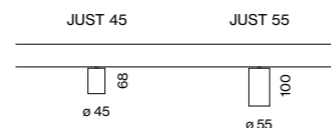

Colours



Light distributions

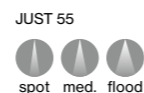
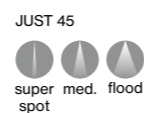

ARY rod
p.734

ARY shade
p.736

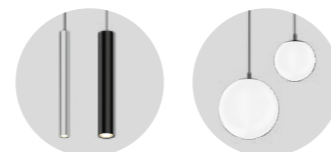

TULA
p.742

PAL
p.748

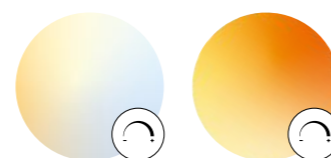

TW 1800–3000K
or 2700–6500K

CWD
2000–3000K

Order options

COLOUR TEMPERATURE	
2700K	4
3000K	5
4000K	6
colour warm dim. 2000–3000K*	
tunable white 1800–3000K**	
tunable white 2700–6500K**	

*DALI-2 **DALI-2 DT8

CONTROL	
non DIM	1
DALI-2	3

MATERIAL COLOUR	
○ traffic white RAL 9016	7
● jet black RAL 9005	8
● special colours p.992	X

BEAM ANGLE JUST 45	
medium 23°	M
flood 44°	F

BEAM ANGLE JUST 55	
spot 16°	S
medium 28°	M
flood 37°	F

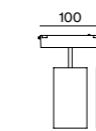
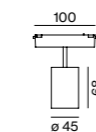

JUST 45



SPOTLIGHT

INSET POWER	LUMINOUS FLUX	ORDER CODE
6.1W super spot 8°	297lm	050-0131::3V
11W	788lm	050-0131::3V
12W CWD 2000–3000K	430lm	050-0131E3V
11W TW 1800–3000K	555lm	050-0131L3V
11W TW 2700–6500K	683lm	050-0131D3V

JUST 55



SPOTLIGHT

INSET POWER	LUMINOUS FLUX	ORDER CODE
15.9W	1300lm	050-0143::3V
30W	2090lm	050-0142::3V

Optical accessories

HONEYCOMB LOUVER

TYPE	Ø-H (mm)	ORDER CODE
JUST 45	42·3	007-1965188
JUST 55	50·3	007-1965598

INSET POWER in watts is the current consumption excluding any ballast
LUMINOUS FLUX value calculated for 3000K, CRI ≥ 90, colour white, lens flood 2700K -5%, 4000K +5%

The Raum Bolzano, IT –
by bergundtal gmbh.



[← back](#)

Quickinfo

PET felt
 ♻️ from recycled material
 up to absorption class A

Type

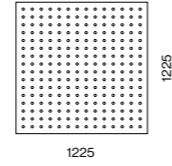

Colours



Order options

MATERIAL COLOUR **W**
 white **W**
 black **L**

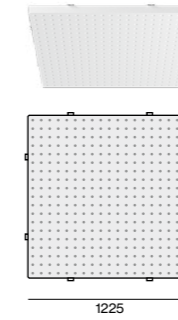

MOVE IT 45 suspended

MOVE IT ACOUSTIC SQUARE

TYPE	L-W-H (mm)	ORDER CODE
1200 inlay MOVE IT system*	1225·1225·57	050-230222 <input checked="" type="checkbox"/>

*NODE connector + track 1220mm

ACOUSTIC EXAMPLES

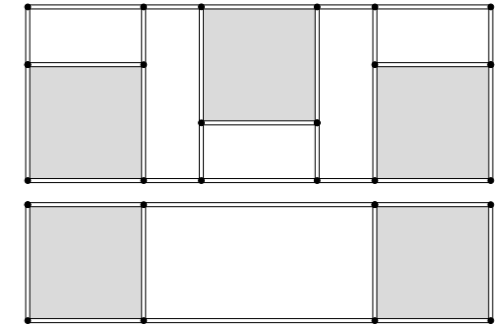

ACOUSTIC elements

accessory 45

EN Highly effective acoustic element made of self-supporting, recycled PET felt; direct sound is absorbed by the front-mounted fleece, sound reflected from the ceiling by an additional, rear-mounted fleece; this creates high acoustic performance; for installation in the MOVE IT 45 suspended system composed of node connectors and 1220 mm profiles

ES Elemento acústico de alta eficacia fabricado de fieltro PET reciclado y autoportante; absorción del ruido directo por el vellón delantero, así como absorción del ruido reflejado por el techo mediante un vellón adicional trasero; con ello gran rendimiento acústico; para la integración en el sistema suspendido MOVE IT 45, compuesto de uniones y perfiles de 1220 mm de largo

Ultra-slim office series

TASK system

EN In addition to impressive flexibility, the ultra-slim TASK series meets all requirements of modern office lighting. Innovative technology and highly efficient LEDs meet minimalistic design. Thanks to its microprismatic cover, TASK provides bright and glare-minimised work light. The product family with a shared sleek design is impressive: TASK can be expanded into a system via a click mechanism. The optional indirect light delivers pleasant ceiling illumination. Additional built-in sensors allow the TASK S system to adapt to motion and ambient brightness. The system can be expanded with optional acoustic elements to optimise room acoustics.

ES La serie ultraesbelta TASK satisface todos los requisitos de la moderna iluminación de oficinas, además de ofrecer una impresionante flexibilidad. Una tecnología innovadora y unos LED extremadamente eficientes se combinan con un diseño minimalista. Gracias a su difusor microprismático, TASK emite una luz apta para espacios de trabajo y con un deslumbramiento mínimo. Esta familia de productos cautiva por su diseño esbelto y uniforme, pudiendo ampliarse con otros componentes en un sistema mediante un mecanismo de clic. La luz indirecta opcional proporciona una iluminación de techo agradable. El sistema TASK S y la luminaria de pie incorporan sensores de movimiento y de la luminosidad del entorno, para obtener una acústica ambiental óptima, el sistema puede ampliarse con elementos acústicos opcionales.

Types

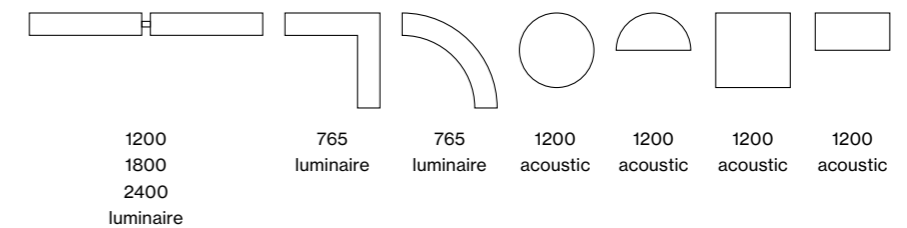

Mounting

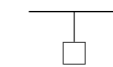

suspended

Configurations



linear

corner

curve

Light distributions

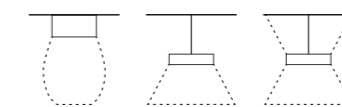

microprismatic
(UGR ≤ 19)

direct

direct/indirect

Ultra-slim and versatile

EN TASK combines an ultra-slim design with innovative lighting technology. These include, in particular, an LGP (Light Guiding Prism), which directs the laterally coupled light from highly efficient LEDs upwards and downwards. It creates a pleasant room atmosphere through a balanced relationship between direct and indirect light.

ES TASK combina un diseño ultrafino con una tecnología de iluminación innovadora. A esta pertenece, entre otros elementos, un prisma LGP (Light Guiding Prism) encargado de guiar hacia arriba y hacia abajo la luz acoplada lateralmente procedente de LED ultraeficientes. Esto crea una relación equilibrada entre la luz directa y la indirecta, que da como resultado una atmósfera interior agradable.

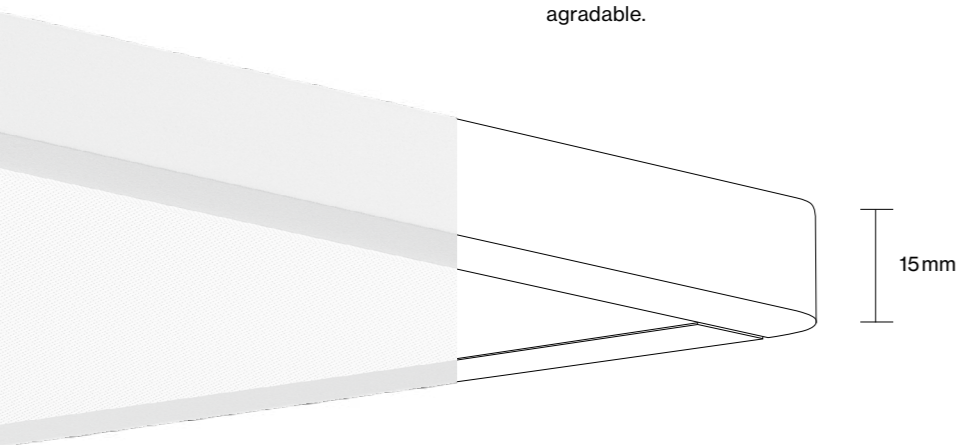

Simple click

EN Design freedom thanks to plug-in connections. Each TASK S system luminaire can be rearranged, combined, and electrically connected with just one click and without any tools. Whether office extension or interior redesign, this lighting system can handle any change.

ES Libertad de configuración gracias a conexiones electromecánicas: cada luminaria de un sistema TASK S puede reordenarse, combinarse y conectarse eléctricamente sin necesidad de herramientas con un solo clic. Y, en caso de que se deba ampliar la oficina o rediseñar el espacio existente, el sistema de iluminación es capaz de adaptarse fácilmente a cualquier modificación.

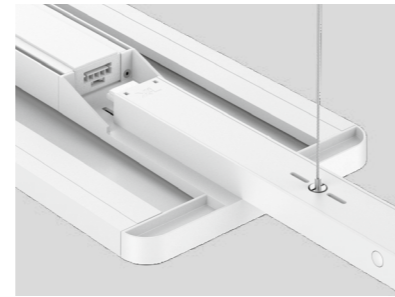

Pleasant room acoustics

EN In addition to lighting, pleasant room acoustics have an impact on job satisfaction. Acoustic element panels in different colours and made of 60% recycled PET complement the TASK series and reduce background noise around the office. For focused, productive work.

ES Además de la iluminación, una acústica ambiental agradable influye en nuestra confortabilidad en el lugar de trabajo. Unos paneles acústicos en distintos colores fabricados de un 60% de PET reciclado completan la serie TASK y reducen el ruido ambiental en la oficina. Para un trabajo concentrado y productivo.

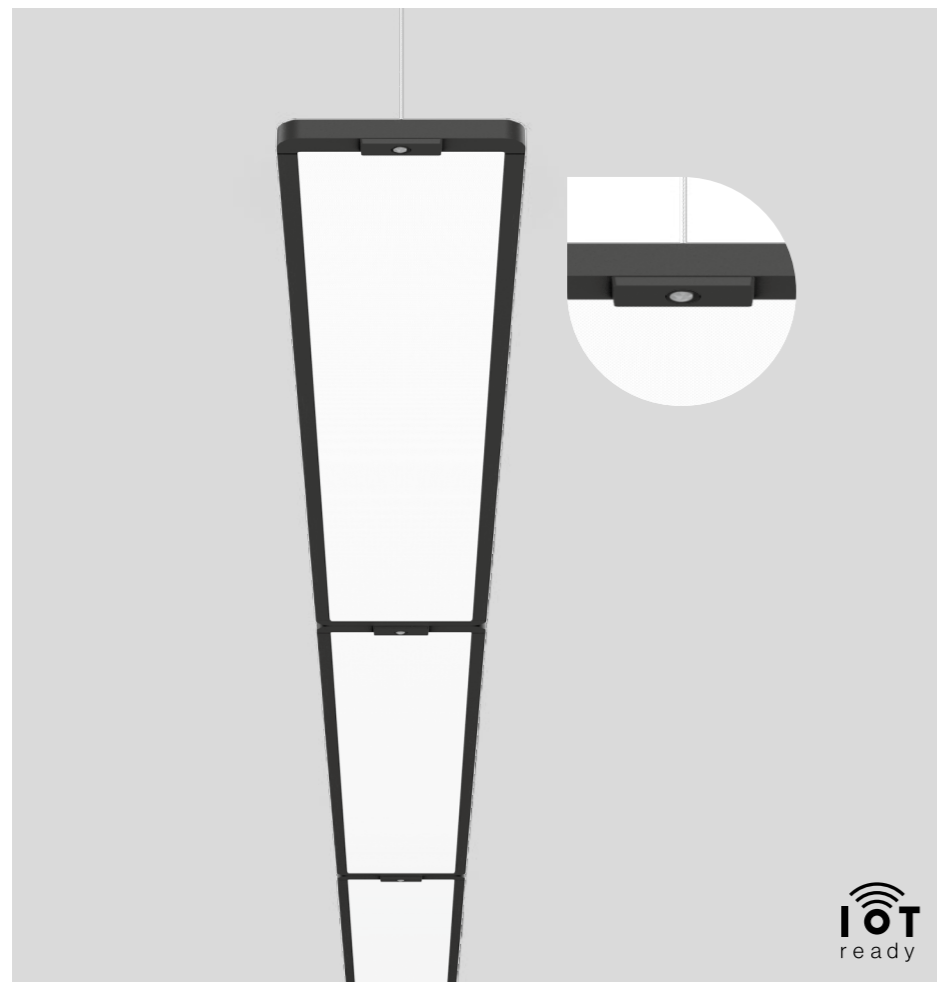

Advanced sensor technology

EN The TASK S system luminaire adapts to daylight and room activity. Integrated motion sensors automatically dim the lighting when no one is in the room. Smart movement sensors enable the light intensity to be adjusted to the ambient brightness. This saves energy and creates a dynamic, natural lighting atmosphere.

ES La luminaria de sistema TASK S se adapta a la luz del día y a la actividad de la sala. Los sensores de movimiento integrados atenúan automáticamente la iluminación cuando la sala está vacía. Unos sensores Daylight inteligentes permiten adaptar la intensidad luminosa a la luminosidad del entorno. Esto ahorra energía y crea un ambiente luminoso dinámico y natural.

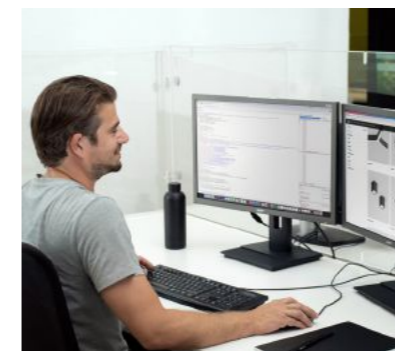

Screen-work friendly

EN TASK guarantees standard-compliant illumination of workplaces with custom anti-glare prisms. An ideal light source for double workstations in open-plan offices and for single workstations in smaller offices – all with reduced reflections.

ES TASK garantiza una iluminación de puestos de trabajo adaptada a la normativa mediante el uso de prismas especiales antideslumbrantes. Una fuente de luz ideal para puestos de trabajo dobles en oficinas de gran tamaño, pero también para puestos de trabajo individuales en oficinas pequeñas, y además con mínimos reflejos.

Full-spectrum LED

EN XAL's new XPECTRUM LEDs deliver healthy, biologically effective light. The reduced blue light and increased cyan values reduce the blue light hazard for the eye to daylight-equivalent levels. The resulting non-visual, so-called melanopic light effect, improves concentration and increases sleep quality. The excellent colour rendering of IES TM 30-15 $R_f=98$ and $R_g=101$ further helps visual comfort.

ES El nuevo LED XPECTRUM de XAL ofrece una luz saludable con efectos biológicos. La menor proporción de luz azul y el aumento de los valores de cian minimizan el riesgo de la incidencia de luz azul en el ojo, manteniéndola a un nivel similar al presente en la luz natural. El efecto no visible resultante, denominado efecto melanópico, fomenta la concentración y mejora la calidad del sueño. Además, su excelente reproducción cromática –con índices $R_f=98$ y $R_g=101$ según la norma IES TM-30-15– garantiza una mayor comodidad visual.

XPECTRUM LED

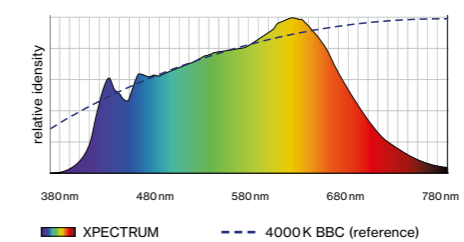

Commercially available LED 4000K

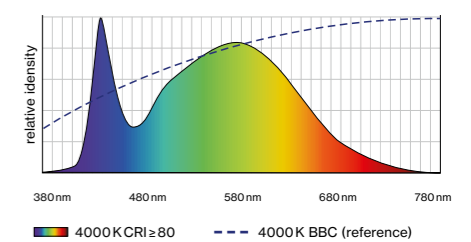

← back

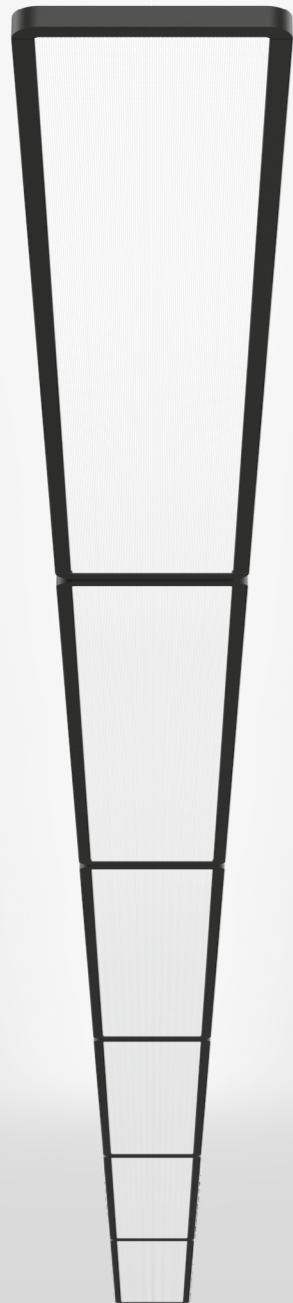

TASK S system

suspended

EN Luminaire housing made of aluminium – rounded edges; rectangular, L-shaped or quarter circle segment design; ultra low-profile design (only 15 mm); for lighting systems; powder coated; cable suspension, tool-less height adjustment; convenient quick mounting system without tools; direct or direct/indirect light distribution by LGP body (Light Guiding Prism); side coupled light, directed downwards or up and down by laser engraving; light control via highly reflective reflector material; optional: indirect component – special PCBs for increased luminous flux (max. ceiling illumination); completely homogeneous illumination; energy-eff. LEDs – very good colour rendering; canopy for through wiring; sound absorb. accessories available

ES Cuerpo de aluminio - bordes redond.; rectangular, en L o segmento 1/4 de círculo; perfil extraplano (sólo 15 mm); para sistemas de ilumin.; recubr. de pintura en polvo; suspensión por cable de altura regulable sin herram.; sistema montaje rápido sin herram.; distribución de luz directa o dir./indir. por cuerpo LGP (Light Guiding Prism); la luz acoplada lateralmente se orienta hacia abajo o hacia arriba/abajo por un grabado láser; dirección de luz por elemento altamente reflectante; opcional: comp. luz indir. – plet. propias para más flujo luminoso (máx. alumbr. del techo); iluminación totalm. homogénea; LED energét. efic. – excelente reprod. crom.; remate de techo para cableado; accesorio absorbedor del ruido disponible

Quickinfo

3000K, 4000K, TW
 CRI ≥ 90, 3 SDCM
 UGR ≤ 19 / 65° ≤ 3000 cd/m²
 up to 124lm/W
 L80 @ 50 000 h
 DALI-2, DALI sensor
 microprismatic (UGR ≤ 19)

Types

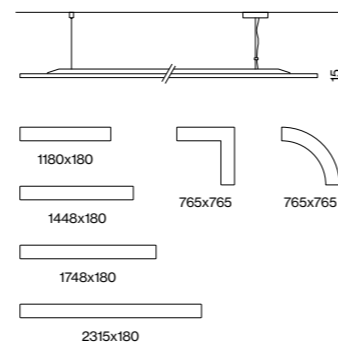

Colours



Light distributions

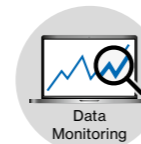
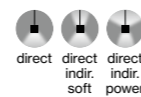

DiiA® standards
251, 252, 253



single luminaire
(p. 432)



acoustic
elements (p. 456)

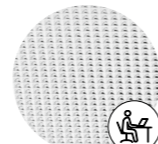

DIN EN 12464-1
UGR ≤ 19



click-
system



system
connector

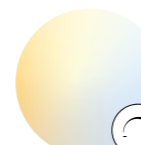

tunable white
2700–6500 K

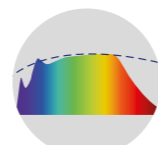

CRI ≥ 98
XPECTRUM

Order options

COLOUR TEMPERATURE

3000 K	0
4000 K	1
tunable white 2700–6500 K*	

*DALI-2 DT8; CRI ≥ 80

3000 K + TW 2700–6500 K	
4000 K + TW 2700–6500 K	
DALI-2 DT8 (separately controllable)	

CONTROL

DALI-2	3
DALI sensor*	7

*version with sensor: length + 9 mm

MATERIAL COLOUR

○ pure white RAL 9010	7
● jet black RAL 9005	8

Options on request

COLOUR RENDERING INDEX

CRI ≥ 80	
CRI ≥ 98 XPECTRUM	

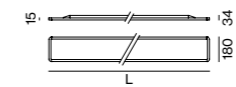

TASK S LINEAR suspended

DIRECT

SYS. POWER	COLOUR TEMP.	LUM. FLUX	L (mm)	ORDER CODE
12.9 W	3000 K	1460 lm	1180	059-5744::K
	4000 K	1550 lm		
16.1 W	3000 K	1820 lm	1448	059-5745::K
	4000 K	1940 lm		
19.3 W	3000 K	2190 lm	1748	059-5746::K
	4000 K	2330 lm		
25.7 W	3000 K	2920 lm	2315	059-5748::K
	4000 K	3110 lm		

DIRECT / INDIRECT SOFT

SYS. POWER	COLOUR TEMP.	LUM. FLUX	L (mm)	ORDER CODE
19.5 W	3000 K	↓ 1900 / ↑ 327 lm	1180	059-5754::K
	4000 K	↓ 2020 / ↑ 347 lm		
24.4 W	3000 K	↓ 2380 / ↑ 408 lm	1448	059-5755::K
	4000 K	↓ 2540 / ↑ 435 lm		
29.2 W	3000 K	↓ 2860 / ↑ 490 lm	1748	059-5756::K
	4000 K	↓ 3040 / ↑ 521 lm		
39 W	3000 K	↓ 3810 / ↑ 653 lm	2315	059-5758::K
	4000 K	↓ 4050 / ↑ 695 lm		

DIRECT / INDIRECT POWER

SYS. POWER	COLOUR TEMP.	LUM. FLUX	L (mm)	ORDER CODE
42 W	3000 K	↓ 3190 / ↑ 1680 lm	1180	059-5764::K
	4000 K	↓ 3400 / ↑ 1790 lm		
49 W	3000 K	↓ 3190 lm	1180	059-57D40::K
(2 × DALI)	2700–6500 K	± 2090 lm		
49 W	4000 K	↓ 3400 lm	1180	059-57D41::K
(2 × DALI)	2700–6500 K	± 2090 lm		
62 W (2 ×)	2700–6500 K	± 6060 lm	1180	059-5764D::K
53 W	3000 K	↓ 3990 / ↑ 2100 lm	1448	059-5765::K
	4000 K	↓ 4250 / ↑ 2230 lm		
61 W	3000 K	↓ 3990 lm	1448	059-57D50::K
(2 × DALI)	2700–6500 K	± 2610 lm		
61 W	4000 K	↓ 4250 lm	1448	059-57D51::K
(2 × DALI)	2700–6500 K	± 2610 lm		
78 W (2 ×)	2700–6500 K	± 7570 lm	1448	059-5765D::K
63 W	3000 K	↓ 4790 / ↑ 2520 lm	1748	059-5766::K
	4000 K	↓ 5100 / ↑ 2680 lm		
71 W	3000 K	↓ 4790 lm	1748	059-57D60::K
(2 × DALI)	2700–6500 K	± 2940 lm		
71 W	4000 K	↓ 5100 lm	1748	059-57D61::K
(2 × DALI)	2700–6500 K	± 2940 lm		
85 W (2 ×)	2700–6500 K	± 8530 lm	1748	059-5766D::K
84 W	3000 K	↓ 6390 / ↑ 3360 lm	2315	059-5768::K
	4000 K	↓ 6800 / ↑ 3580 lm		
92 W	3000 K	↓ 6390 lm	2315	059-57D80::K
(2 × DALI)	2700–6500 K	± 4180 lm		
92 W	4000 K	↓ 6800 lm	2315	059-57D81::K
(2 × DALI)	2700–6500 K	± 4180 lm		
118 W (2 ×)	2700–6500 K	± 12120 lm	2315	059-5768D::K

Light distributions

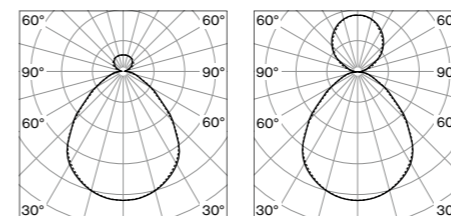

microprismatic direct/indirect soft
 microprismatic direct/indirect power

LUMINOUS FLUX value calculated for CRI ≥ 90, colour white, cover microprismatic

Mounting accessories

see page 814

Order options

CORNER ⚡

without power feeder	2
with power feeder	3

COLOUR TEMPERATURE ⚡

3000K	0
4000K	1

CONTROL

DALI-2	
--------	--

MATERIAL COLOUR

○ pure white RAL 9010	7
● jet black RAL 9005	8

Options on request

COLOUR RENDERING INDEX

CRI ≥ 80	
CRI ≥ 98 XPECTRUM	

TASK S CORNER/CURVE suspended

incl. cable suspension 1500 mm

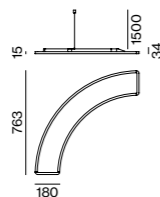
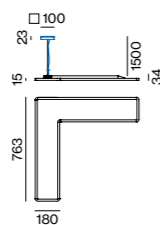

	CRI ≥ 98	UGR ≤ 19	cd/m² ≤ 3000	RG0 IEC 62471	BALD 1ADDR.	220-240V	X-PERT	X-PERT
--	----------	----------	--------------	---------------	-------------	----------	--------	--------

DIRECT

SYS. POWER	COLOUR TEMP.	LUM. FLUX	L (mm)	ORDER CODE
15W	3000K	1700lm	765	0 5 9 - 5 8 4 ⚡ :: 3 ⚡ K
corner	4000K	1810lm		

12.9W	3000K	1460lm	765	0 5 9 - 5 5 4 2 :: 3 ⚡ K
curve	4000K	1550lm		

	CRI ≥ 98	UGR ≤ 19	cd/m² ≤ 3000	RG0 IEC 62471	BALD 1ADDR.	220-240V	X-PERT	X-PERT
--	----------	----------	--------------	---------------	-------------	----------	--------	--------

DIRECT / INDIRECT SOFT

SYS. POWER	COLOUR TEMP.	LUM. FLUX	L (mm)	ORDER CODE
22.7W	3000K	↓ 2220 / ↑ 381lm	765	0 5 9 - 5 8 5 ⚡ :: 3 ⚡ K
corner	4000K	↓ 2370 / ↑ 407lm		

	CRI ≥ 98	UGR ≤ 19	RG0 IEC 62471	BALD 1ADDR.	220-240V	X-PERT	X-PERT
--	----------	----------	---------------	-------------	----------	--------	--------

DIRECT / INDIRECT POWER

SYS. POWER	COLOUR TEMP.	LUM. FLUX	L (mm)	ORDER CODE
49W	3000K	↓ 3680 / ↑ 1890lm	765	0 5 9 - 5 8 6 ⚡ :: 3 ⚡ K
corner	4000K	↓ 3920 / ↑ 2010lm		

42W	3000K	↓ 3150 / ↑ 1610lm	765	0 5 9 - 5 5 6 2 :: 3 ⚡ K
curve	4000K	↓ 3350 / ↑ 1720lm		

Mounting accessories

LINEAR / CORNER 90° CONNECTOR incl. cable suspension 1500 mm

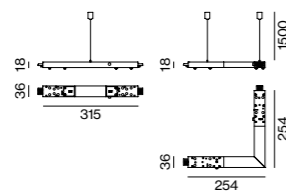

TYPE	L (mm)	ORDER CODE
linear mechanical & electrical	10	0 5 9 - 2 7 9 2 3 1 ⚡
linear mechanical	10	0 5 9 - 2 7 9 2 4 1 ⚡
corner 90° mechanical & electrical	254x254	0 5 9 - 2 7 9 2 7 1 ⚡
corner 90° mechanical	254x254	0 5 9 - 2 7 9 2 8 1 ⚡

SYSTEM CONNECTOR incl. cable suspension 1500 mm

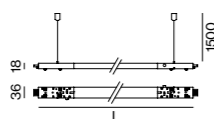

TYPE	L (mm)	ORDER CODE
mechanical & electrical	800	0 5 9 - 2 7 9 2 3 2 ⚡
mechanical & electrical	1200	0 5 9 - 2 7 9 2 3 3 ⚡
mechanical & electrical cuttable	1200	0 5 9 - 2 7 9 2 3 0 ⚡
mechanical & electrical cuttable	2400	0 5 9 - 2 7 9 2 3 4 ⚡
optional cable suspension	1500	0 5 9 - 2 7 9 2 1 2 7

END PIECE incl. cable suspension 1500 mm

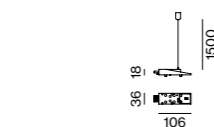

TYPE	L (mm)	ORDER CODE
end piece	1500	0 5 9 - 2 7 9 2 1 1 ⚡

POWER FEEDER incl. cable suspension 1500 mm and canopy / feeder cable

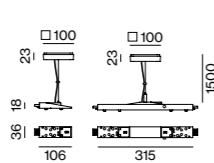

TYPE	L (mm)	ORDER CODE
power feeder 5x1.5mm²	1500	0 5 9 - 2 7 9 2 2 1 ⚡
middle power feeder 5x1.5mm²	1500	0 5 9 - 2 7 9 2 5 1 ⚡

for electrical system configuration see luminaire data sheet at xal.com

Light distributions

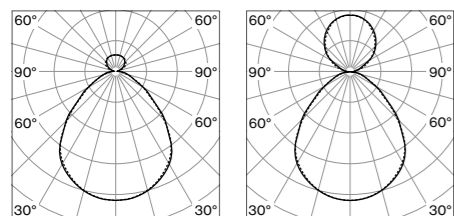

microprismatic direct/indirect soft microprismatic direct/indirect power

LUMINOUS FLUX value calculated for colour white, cover microprismatic



L'Oréal Vienna, AT - by Philipp Grem

Clariant Lodz, PL –
by The Design Group
with lighting design
by Plus Lighting



Training center GBU Ritual
Moscow, RU – by Khvorostyaniy T. &
Semionov A. with lighting design by
KA2 Light Architecture



← back

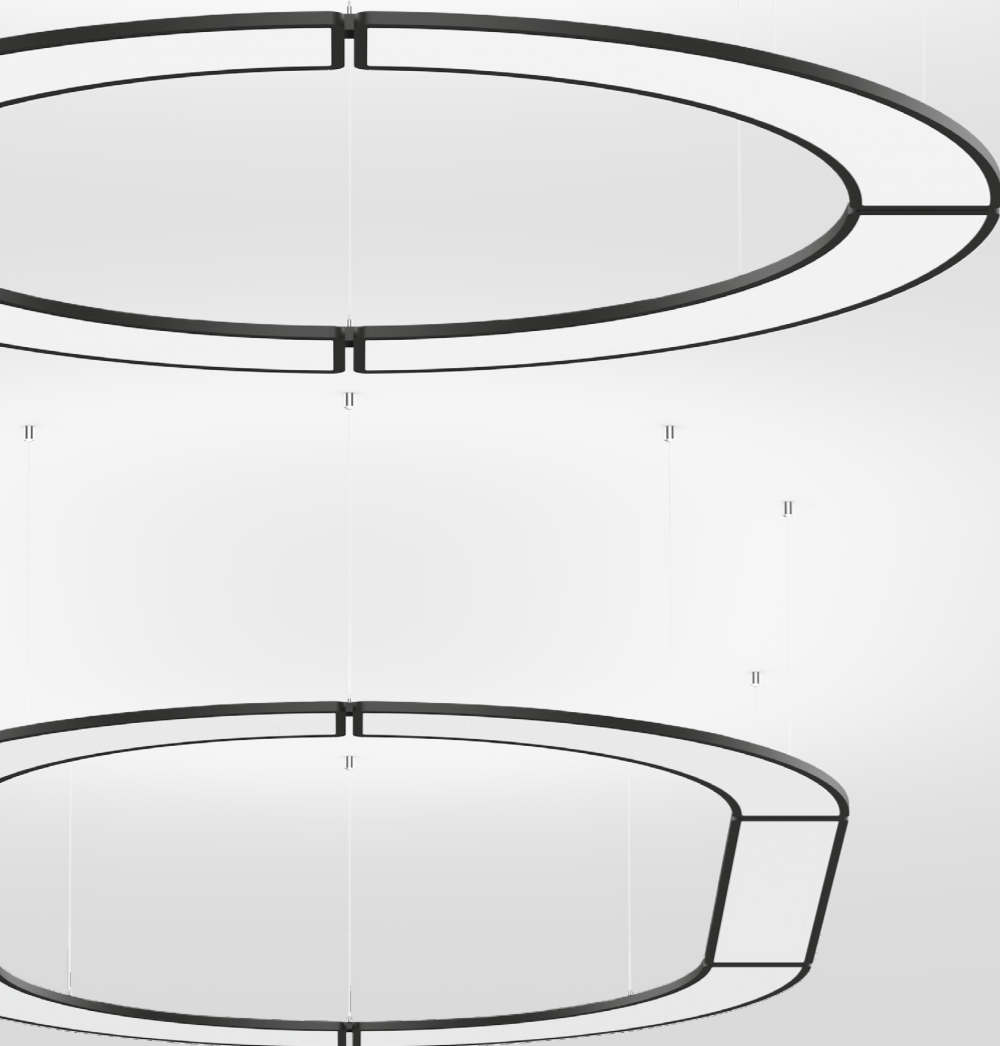

TASK circle suspended

EN Ring-shaped suspended luminaire, consisting of single elements in quarter circle or rectangular shape; Luminaire housing made of aluminium – rounded edges; ultra low-profile design (only 15 mm); surface powder coated; cable suspension, tool-less height adjustment; convenient quick mounting system without tools; incl. transparent feed; direct light distribution by LGP body (Light Guiding Prism); side coupled light directed downwards by laser engraving; indirect component with special PCBs for increased luminous flux and maximum ceiling illumination; completely homogeneous illumination; energy-eff. LEDs – very good colour rendering; canopy for through wiring; optional acoustic elements available

ES Luminaria anular suspendida con elementos individuales en 1/4 de anillo o rectangulares; cuerpo de aluminio – bordes redondeados; perfil extraplano (sólo 15 mm); superficie con recubr. de pintura en polvo; suspensión por cable de altura regul. sin herram.; sistema de montaje rápido sin herram.; con cable de aliment. transparente; distribución de luz directa por cuerpo LGP (Light Guiding Prism); la luz acoplada lateralmente se orienta hacia abajo por grabado láser; comp. de luz indirecta con pletinas propias para mayor flujo luminoso y el máx. alumbr. del techo; iluminación totalmente homogénea; LEDs energéticamente eficientes – excelente reproducción cromática; remate de techo para cableado; elementos acústicos opcionales



Quickinfo

4000K
CRI ≥ 90, 3 SDCM
UGR ≤ 19 / 65° ≤ 3000 cd/m²
up to 117 lm/W
L95 @ 50 000h
DALI-2
microprismatic (UGR ≤ 19)

acoustic elements
PET felt
♻️ from recycled material
up to absorption class A
🔥 available as B-s1, d0

Types

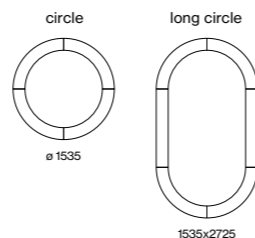

Luminaire colours



Acoustic colours



Light distribution

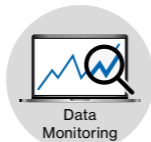

DiiA® standards
251, 252, 253



click-system

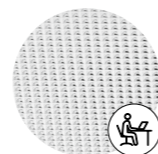

DIN EN 12464-1
UGR ≤ 19

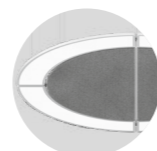

acoustic elements

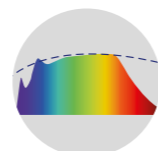

CRI ≥ 98
XPECTRUM

Order options

COLOUR TEMPERATURE
4000K

CONTROL
DALI-2

LUMINAIRE COLOUR
○ pure white RAL 9010 7
● jet black RAL 9005 8

ACOUSTIC COLOUR
○ white W
● marble grey D
● felt grey G
● black L
● special colours p.992 X

LIGHT OPTIC COVER
microprismatic (UGR ≤ 19)

Options on request

COLOUR RENDERING INDEX
CRI ≥ 80
CRI ≥ 98 XPECTRUM

FORM

for other configurations see
TASK S suspended system

Light distribution

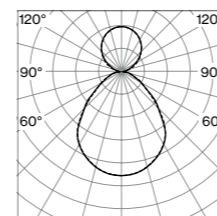

microprismatic
direct/indirect power

LUMINOUS FLUX value calculated for
CRI ≥ 90, colour white, cover microprismatic

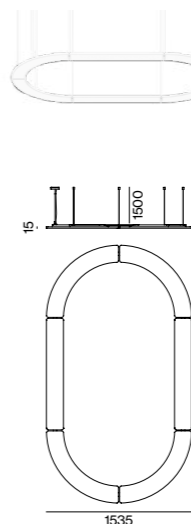
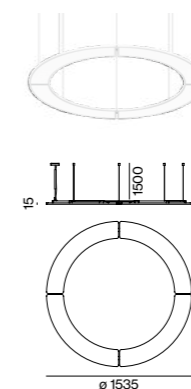

TASK circle suspended



DIRECT / INDIRECT POWER

SYSTEM POWER	COLOUR TEMP.	LUMINOUS FLUX	ORDER CODE
169W	4000K	↓ 12900 / ± 6870 lm	059-528113 <input checked="" type="checkbox"/> K

TASK long circle suspended



DIRECT / INDIRECT POWER

SYSTEM POWER	COLOUR TEMP.	LUMINOUS FLUX	ORDER CODE
252W	4000K	↓ 20200 / ± 10460 lm	059-528213 <input checked="" type="checkbox"/> K

Technical data

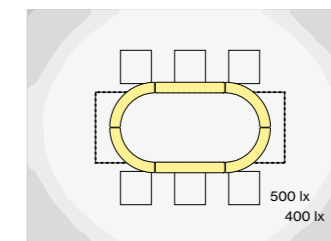

TASK long circle
252W, 4000K, direct/indirect power

ROOM VALUES

Room dimensions	5.4 × 4 × 2.8 m
Reflection factor	0.7 0.5 0.2
Maintenance factor	0.8
Suspension height	2.25 m

CALCULATION SURFACE

Surface dimensions	3.2 × 1.2 m
Surface height	0.75 m
Average illuminance (E _m)	> 500 lx
Uniformity (U ₀)	> 0.6

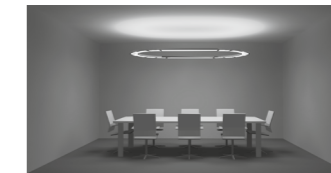

GLARE EVALUATION
Table Classification X=4H | Y=8H | S=0.25H

UGR transversal	≤ 19
UGR axial	≤ 19

Acoustic elements

TASK ACOUSTIC inlay

TYPE	L-W-H (mm)	ORDER CODE
1 TASK circle suspended	1155-1155-30	059-579736 <input checked="" type="checkbox"/>
2 TASK long circle suspended	1155-2346-30	059-579738 <input checked="" type="checkbox"/>

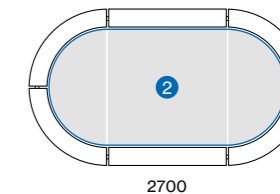
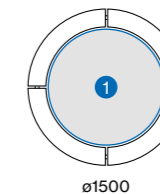



Art Invest Millenium Tower
Vienna, AT –
by LOVE architecture and urbanism

**Compound Semiconductor
Applications Catapult**
Wales, UK – by Monteith Scott



← back

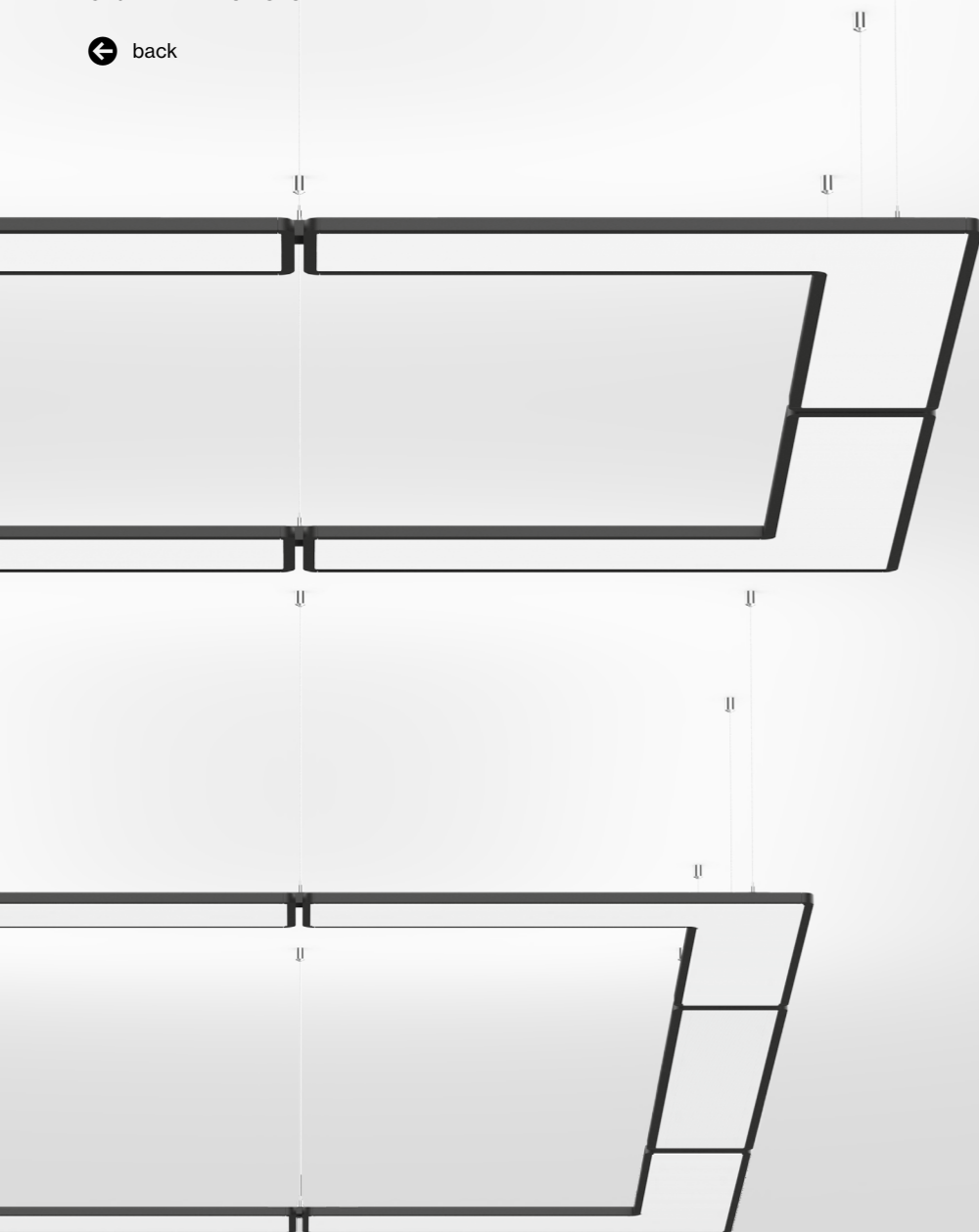

TASK angular suspended

EN Rectangular suspended luminaire, consisting of single L-shaped or rectangular elements; Luminaire housing made of aluminium – rounded edges; ultra low-profile design (only 15 mm); surface powder coated; cable suspension, tool-less height adjustment; convenient quick mounting system without tools; incl. transparent feed; direct light distribution by LGP body (Light Guiding Prism); side coupled light directed downwards by laser engraving; indirect component with special PCBs for increased luminous flux and maximum ceiling illumination; completely homogeneous illumination; energy-eff. LEDs – very good colour rendering; canopy for through wiring; optional acoustic elements available

ES Luminaria pendular rectangular, compuesta por elementos individuales en forma de L o bien rectangulares; Cuerpo de luminaria de aluminio – cantos redondeados; perfil extra plano (sólo 15mm); superficie con recubrimiento de pintura en polvo; suspensión cable altura regulable sin herram.; sistema de montaje rápido sin herramientas; incluido cable de alimentación transparente; distribución de luz directa a través de cuerpo LGP (Light Guiding Prism); la luz acoplada lateralmente se orienta hacia abajo por medio de un grabado por láser; proporción indirecta con pletinas propias para un flujo luminoso aumentado y una iluminación máxima del techo; iluminación homogénea; LED energét. ef. – excelente reprod. crom.; baldaquino para cableado pasante; opcional elementos acústicos disponible

Quickinfo

4000K
CRI ≥ 90, 3 SDCM
up to 118lm/W
L95 @ 50 000h
DALI-2
microprismatic (UGR ≤ 19)

acoustic elements
PET felt
♻️ from recycled material
up to absorption class A
🔥 available as B-s1, d0

Types

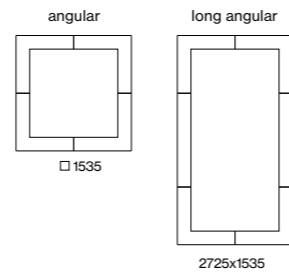

Luminaire colours



Acoustic colours



Light distribution



DiiA® standards
251, 252, 253



click-system

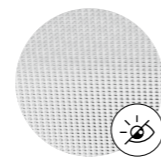

microprismatic (UGR ≤ 19)

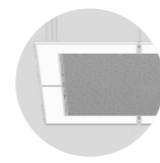

acoustic elements

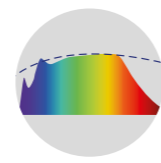

CRI ≥ 98 XPECTRUM

Order options

COLOUR TEMPERATURE
4000K

CONTROL
DALI-2

LUMINAIRE COLOUR
○ pure white RAL 9010 7
● jet black RAL 9005 8

ACOUSTIC COLOUR
○ white W
● marble grey D
● felt grey G
● black L
● special colours p.992 X

LIGHT OPTIC COVER
microprismatic (UGR ≤ 19)

Options on request

COLOUR RENDERING INDEX
CRI ≥ 80
CRI ≥ 98 XPECTRUM

FORM

for other configurations see
TASK S suspended system

Light distribution

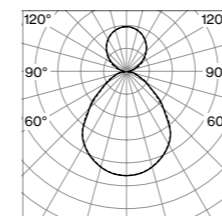

microprismatic
direct/indirect power

LUMINOUS FLUX value calculated for
CRI ≥ 90, colour white, cover microprismatic

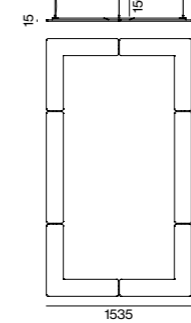
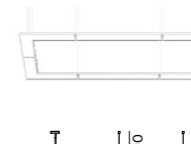
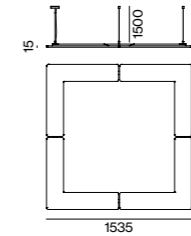
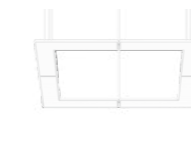

TASK angular suspended



DIRECT / INDIRECT POWER

SYSTEM POWER	COLOUR TEMP.	LUMINOUS FLUX	ORDER CODE
197W	4000K	↓ 15200/± 8050lm	059-528313 K

TASK long angular suspended



DIRECT / INDIRECT POWER

SYSTEM POWER	COLOUR TEMP.	LUMINOUS FLUX	ORDER CODE
280W	4000K	↓ 22480/± 11620lm	059-528413 K

Technical data

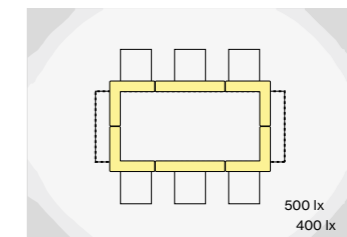

TASK long angular, 280W, 4000K,
direct/indirect power

ROOM VALUES
Room dimensions 5.4 × 4 × 2.8m
Reflection factor 0.7 | 0.5 | 0.2
Maintenance factor 0.8
Suspension height 2.25m

CALCULATION SURFACE
Surface dimensions 3.2 × 1.2m
Surface height 0.75m
Average illuminance (E_m) > 500 lx
Uniformity (U₀) > 0.6

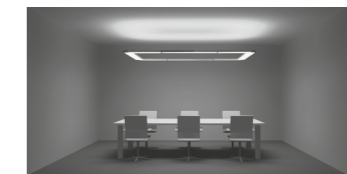

GLARE EVALUATION
Table Classification X=4H | Y=8H | S=0.25H
UGR transversal ≤ 19
UGR axial ≤ 19

Acoustic elements

TASK ACOUSTIC inlay

TYPE	L-W-H (mm)	ORDER CODE
1 TASK angular suspended	1155-1155-30	059-579716 K
2 TASK long angular suspended	1155-2346-30	059-579718 K

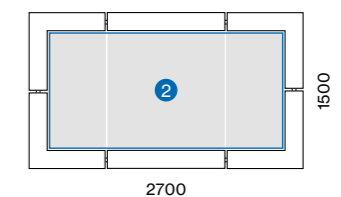
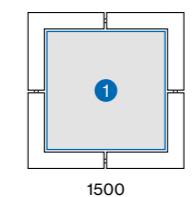

L'Oréal
Vienna, AT –
by Philipp Grem



Community Windpower
Cheshire, UK



Training center GBU Ritual
Moscow, RU – by Khvorostyaniy T. &
Semionov A. with lighting design by
KA2 Light Architecture

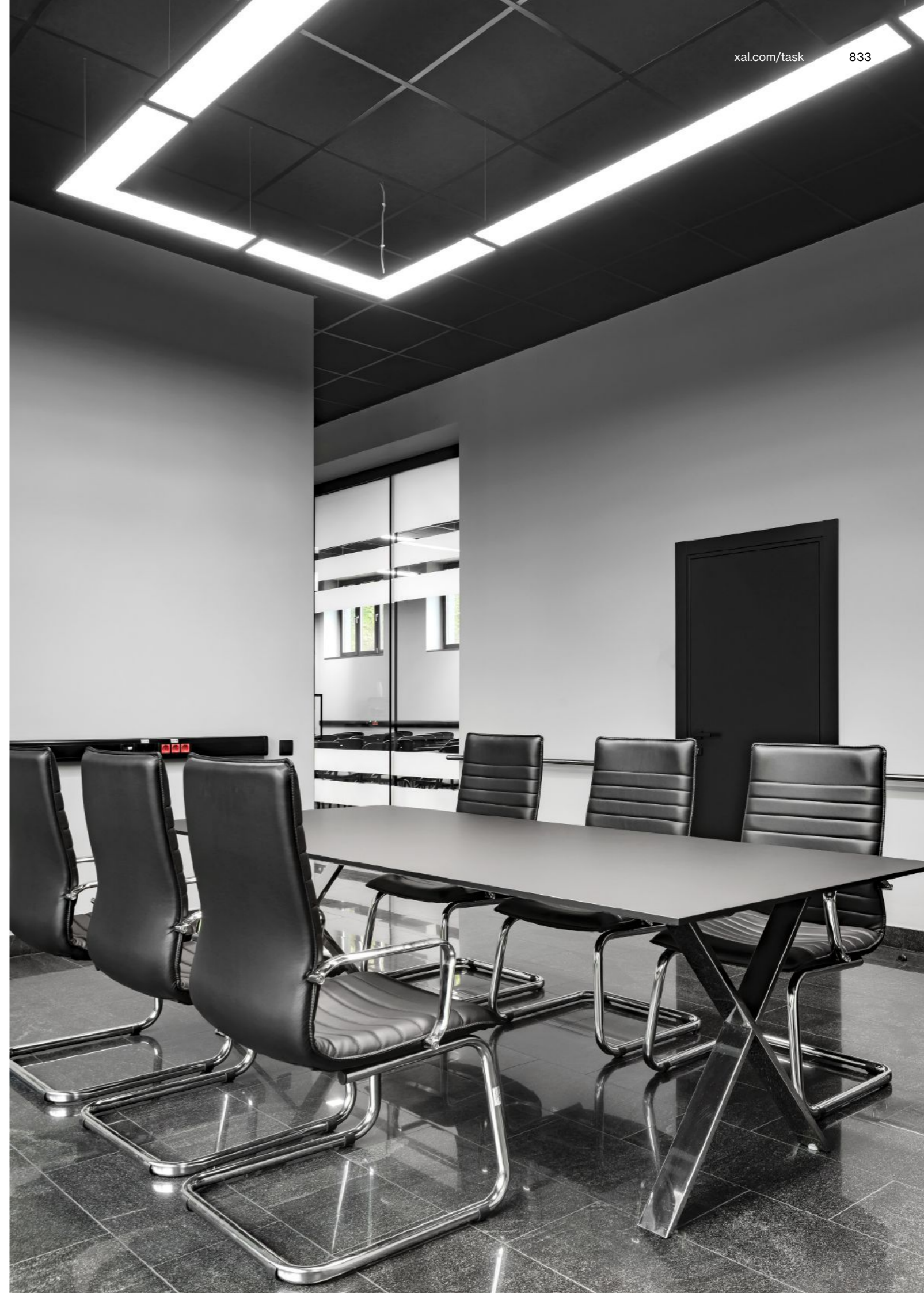

Slim and smart office system

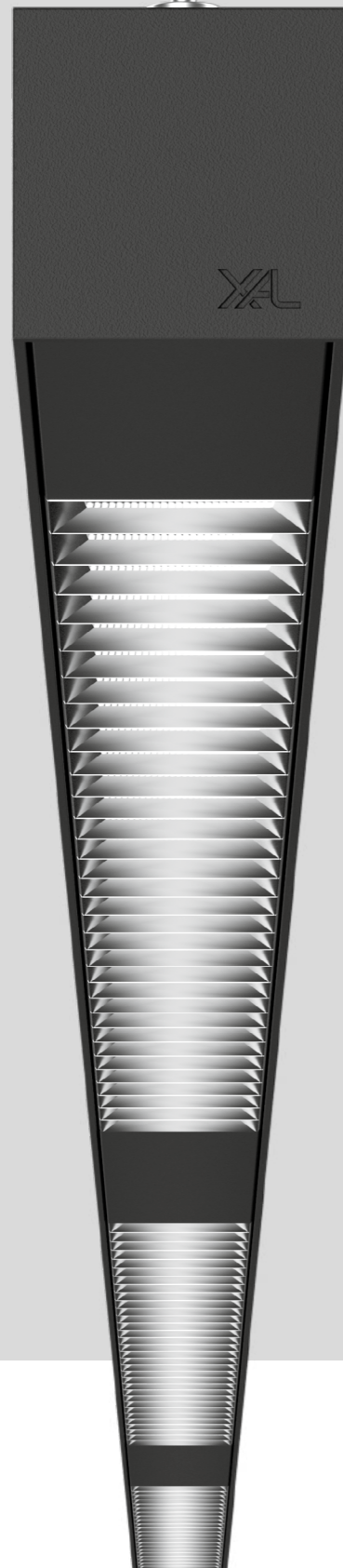

BETO system

EN BETO is extremely slim, powerful, and optimised for office use. It is a system luminaire with an impressive range of flexible elements that can be lined up like building blocks. Available in ceiling-mounted and suspended versions, the system combines technical excellence with subtle, minimalist design. Designed specifically for offices, BETO has custom reflectors to give the best possible user-friendly, ambient monitor lighting. Some variants can be fitted with a brightness and presence sensor. This adapts the lighting to the activity in the office while reducing energy costs. The BETO System has an optional indirect light component for additional ceiling illumination. All curved and straight elements come in 3000 K or 4000 K light colours, and some also have a Tunable White option.

ES Extremadamente esbelta, potente y optimizada para el uso en la oficina: como luminaria modular, BETO destaca por sus elementos flexibles que pueden unirse unos a otros según las necesidades. Tanto la variante de montaje en techo como la variante modular suspendida combinan la excelencia tecnológica con un diseño sutil y minimalista. BETO ha sido concebida para entornos de oficina, y está dotada de reflectores especiales que le permiten ofrecer una óptima luz de trabajo apta. Algunos modelos pueden equiparse incluso con un sensor de presencia y luminosidad. Esto hace que la iluminación se adapte a la dinámica de la oficina, por lo que el coste energético se reduce. BETO System dispone de una fracción de luz indirecta opcional para la iluminación adicional del techo. Todos los elementos curvos o rectilíneos están disponibles en temperaturas de color de 3000 K o 4000 K, algunos de ellos con la opción Tunable White.

Types

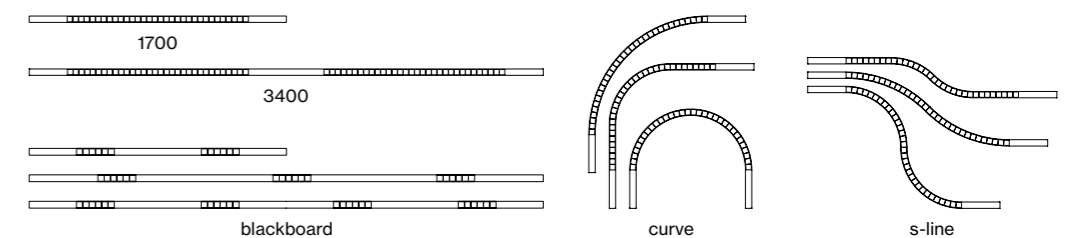

Mountings

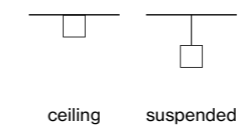

Light distributions

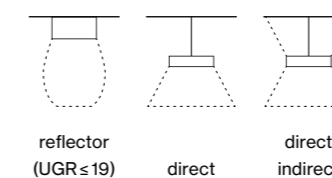

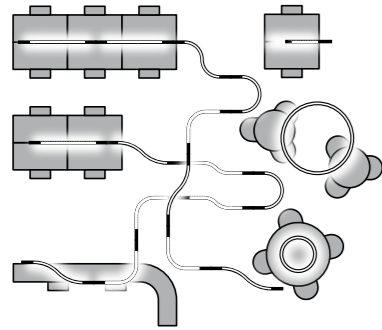

Straight or curved

EN BETO System comes as a suspended luminaire with both straight or curved system elements. Regardless of whether in a linear, curved, or s-shaped design, BETO offers a multifunctional lighting solution that can be integrated into any lighting concept. With an optional indirect light component, the light is distributed homogeneously, creating a pleasant atmosphere.

ES BETO System está disponible como lámpara suspendida con elementos modulares curvos o rectilíneos. Ya se trate de una configuración lineal, curva o en forma de S, BETO es una solución de iluminación polivalente que se integra perfectamente en cualquier esquema de diseño lumínico. Con su proporción de luz indirecta opcional, la luz se distribuye en la sala de manera homogénea y genera una sensación interior agradable.

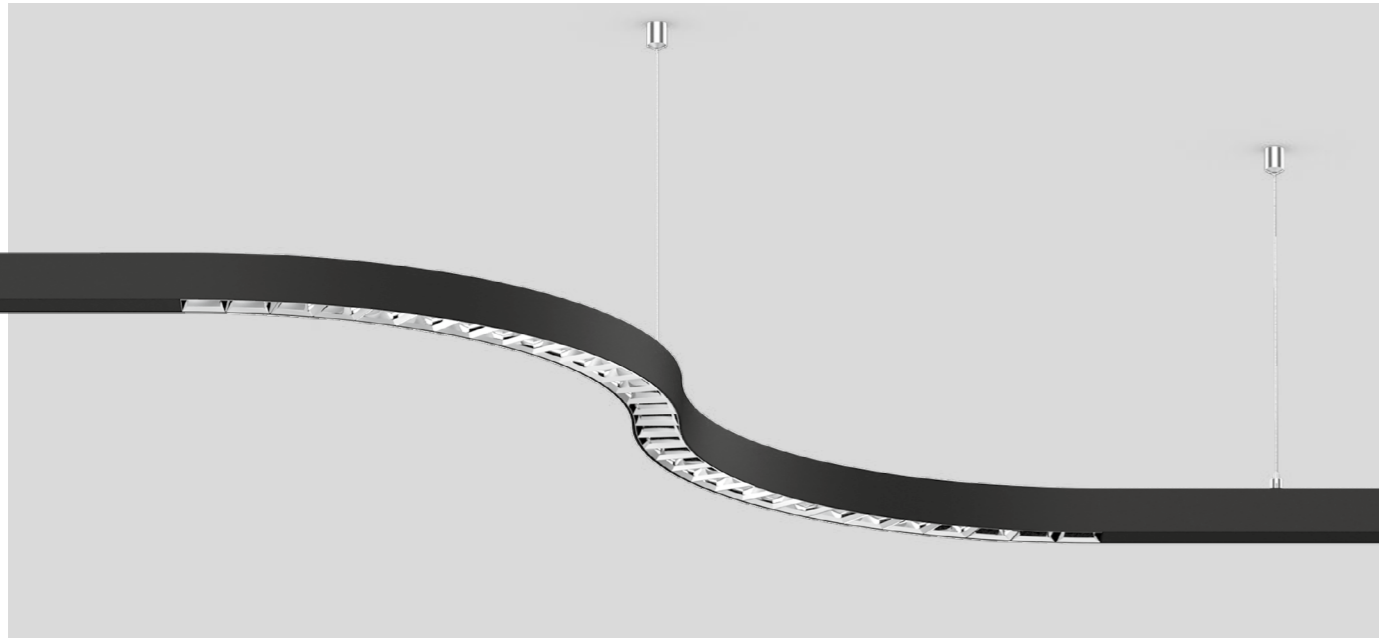

Work-friendly light

EN As an office luminaire, BETO guarantees illumination that is compliant with workplace standards (up to $UGR \leq 13$). Custom glare-free reflectors and the selected use of blind covers direct the light precisely to the work surface and reduce reflections. The direct/indirect version comes with special lens technology that distributes the indirect light component homogeneously and broadly into the room.

ES Como luminaria de oficina, BETO ofrece una iluminación de puestos de trabajo adaptada a la normativa (hasta $UGR \leq 13$). Unos reflectores especiales exentos de deslumbramiento y el empleo selectivo de cubiertas opacas dirigen la luz con precisión a la superficie de trabajo y reducen los reflejos. En la variante directa/indirecta, una tecnología de lentes especial distribuye una proporción de luz indirecta con un patrón de irradiación muy amplio de manera homogénea en la sala.



Blackboard lighting

EN Uniform blackboard illumination is still a primary focus of good classroom lighting to hold attention and remain legible even from the back. It is often helpful during presentations to dim the lighting or to illuminate parts of the room. Pre-programmed lighting scenes can be activated, thus supporting varying teaching requirements.

ES Una de las mayores prioridades en el alumbrado de aulas de enseñanza sigue siendo el ofrecer una iluminación homogénea de la pizarra que garantice una visibilidad y legibilidad óptimas incluso desde la última fila. A su vez, durante presentaciones es conveniente poder atenuar el sistema de iluminación o iluminar solamente partes de la sala. La selección de distintas escenas preprogramadas permite adaptar la iluminación a los cambiantes requisitos didácticos.

Advanced sensor technology



EN BETO System is equipped with a DALI sensor and can be controlled as a network. A presence sensor controls the light at the workstation if someone is there. A brightness sensor adjusts the light intensity to the ambient brightness. If desks, rooms, or corridors are unoccupied, the light automatically switches off after a defined delay. This saves energy and extends the service life.

ES Equipada con un sensor DALI, BETO System puede ser controlada a modo de red. Un sensor de presencia regula la iluminación del puesto de trabajo en función de la presencia de una persona, mientras que un sensor de luminosidad adapta la intensidad de la luz a la luminosidad del entorno. Esto permite que la luz se apague automáticamente en escritorios, salas o pasillos vacíos tras un tiempo de espera determinado, lo cual ahorra energía y prolonga la durabilidad de las luminarias.

Full-spectrum LED

EN XAL's new XPECTRUM LEDs deliver healthy, biologically effective light. The reduced blue light and increased cyan values reduce the blue light hazard for the eye to daylight-equivalent levels. The resulting non-visual, so-called melatonin light effect, improves concentration and increases sleep quality. The excellent colour rendering of IES TM 30-15 $R_f = 98$ and $R_g = 101$ further helps visual comfort.

ES El nuevo LED XPECTRUM de XAL ofrece una luz saludable con efectos biológicos. La menor proporción de luz azul y el aumento de los valores de cian minimizan el riesgo de la incidencia de luz azul en el ojo, manteniéndola a un nivel similar al presente en la luz natural. El efecto no visible resultante, denominado efecto melanópico, fomenta la concentración y mejora la calidad del sueño. Además, su excelente reproducción cromática –con índices $R_f = 98$ y $R_g = 101$ según la norma IES TM-30-15– garantiza una mayor comodidad visual.

XPECTRUM LED

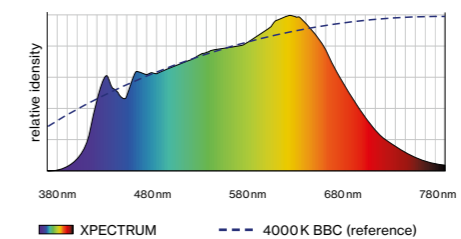

Commercially available LED 4000 K

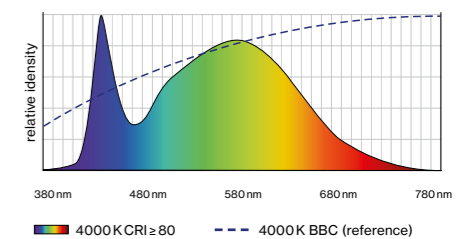

← back

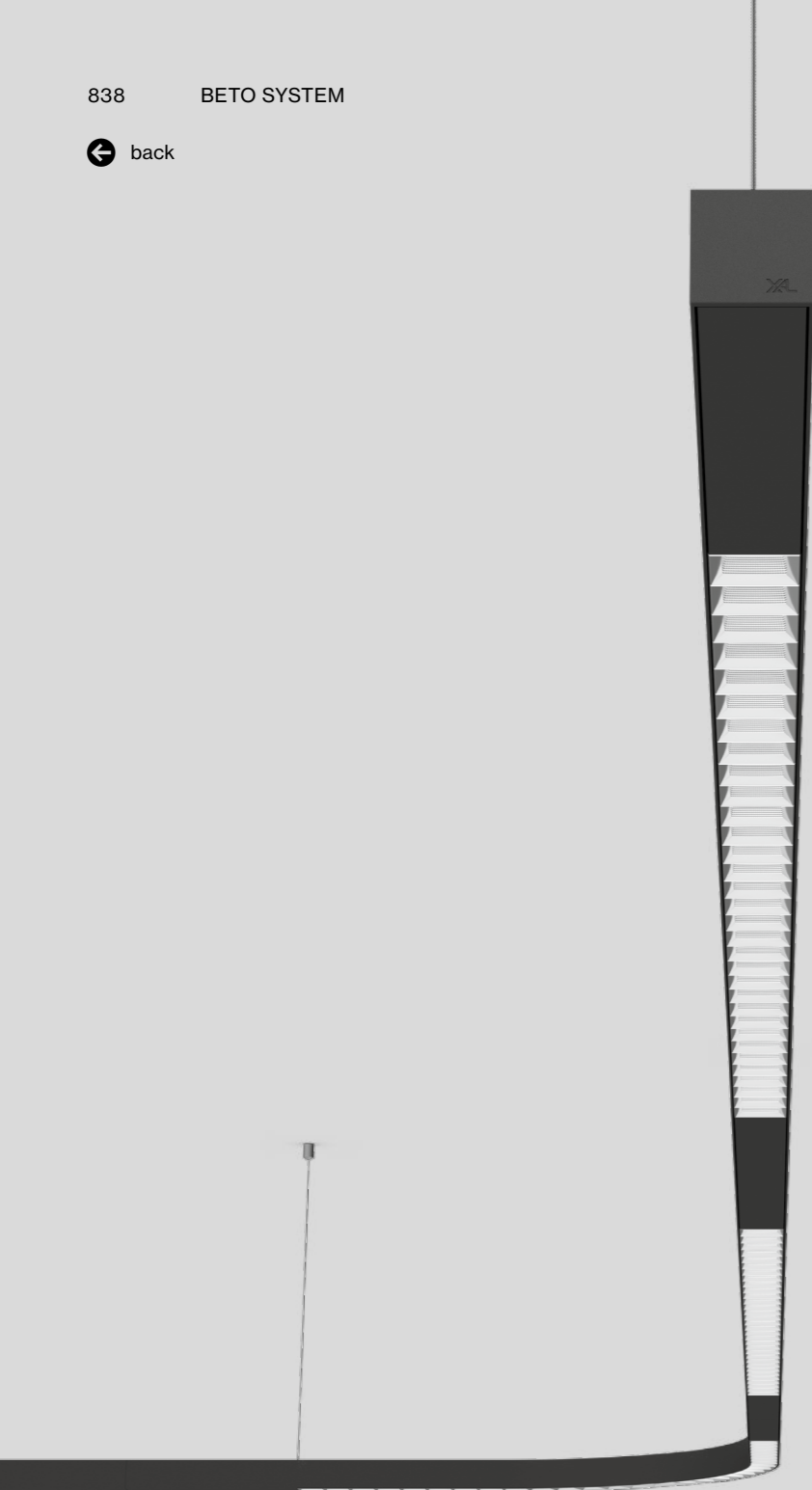

BETO system

ceiling / suspended

EN Luminaire housing from extruded aluminium profile, angular design (only 42x42mm); no visible screws; for lighting systems; linear, S-shaped or CURVE segment (90° or 180°); powder coated; pendant fitting with cable suspension; height adjustment without tools; with transparent feeder cable; extruded profile for improved thermal management; high-gloss reflector with faceted design; direct or direct/indirect light distribution, or with high-quality aluminum-vaporised micro-faceted reflector for homogeneous vertical lighting intensity; indirect light component with integrated PCboards and high-quality lens system for max., homog. ceiling illumination, separately controllable; energy-eff. LEDs – very good colour rendering

ES Cuerpo de perfil de aluminio con diseño angular (solo 42x42mm); sin tornillos visibles; para sistemas de iluminación; lineal, en forma de S o elemento CURVE (de 90° o 180°); recubierto de polvo; suspendido con cable; altura regulable sin herramientas; incl. cable de alimentación transparente; perfil extruido para una mejor gestión del calor; reflector de alto brillo con óptica facetada; proyección directa o directa/indirecta, o con refl. microfacetado de alta calidad metaliz. con aluminio para iluminación vertical homogénea; componente de luz indir. con pler. propias y ópt. de lente de alta calidad para un alumb. de techo máx. y homog. con control indep.; LED energét. efíc. – excelente reprod. crom./ 50 000h; IP20; CP I; a elegir en variante no atenuable, con control DALI-2 o atenuable con sensor infrarrojo de presencia y luminosidad integrado (DALI)

Quickinfo

3000K, 4000K, TW
 CRI ≥ 80, 3 SDCM
 UGR ≤ 19 / 65° ≤ 1500 cd/m²
 L 3400 direct up to 136lm/W
 L 3400 D/I up to 140lm/W
 L 3400 blackboard up to 124lm/W
 L90 @ 50 000 h
 DALI-2, DALI sensor reflector (UGR ≤ 19)

Types

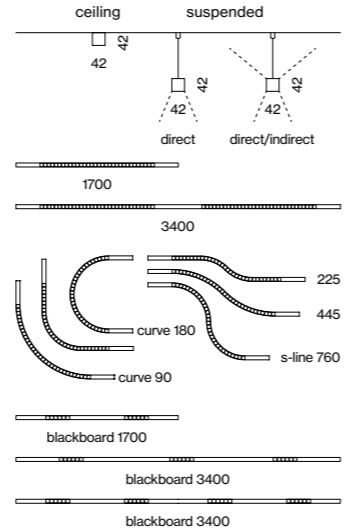

Colours



Light distributions

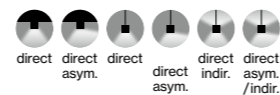

Data Monitoring

curve elements

single luminaire (p. 470)

DIN EN 12464-1 UGR ≤ 19

glare-free direct and 170° indirect illumination

CRI ≥ 98 XPECTRUM

Order options

COLOUR TEMPERATURE	
3000K	5
4000K	6
tunable white 2700–6500 K*	
*DALI-2 DT8	

CONTROL	
DALI-2	3
DALI sensor*	7
*brightness & presence only linear 3400 mm (not blackboard)	

MATERIAL COLOUR	
○ pure white RAL 9010	7
● jet black RAL 9005	8

LIGHT OPTIC COVER	
reflector (UGR ≤ 19)	

Options on request

COLOUR RENDERING INDEX	
CRI ≥ 90	
CRI ≥ 98 XPECTRUM	

SYSTEM SOLUTION	
continuous reflector	
individual length	

Light distributions

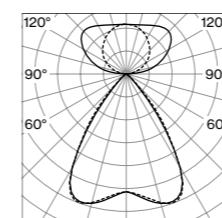

reflector (UGR ≤ 16)
direct/indirect power

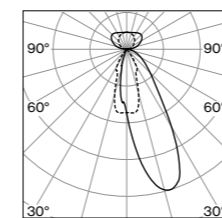

blackboard
direct/indirect

LUMINOUS FLUX value calculated for CRI ≥ 80, colour white, reflector chrome

BETO linear ceiling / suspended system



DIRECT

SYS. POWER	COLOUR TEMP.	LUM. FLUX	L (mm)	ORDER CODE
26.1W (1×DALI)	3000K	3340lm	1700	074-6006
52W (2×DALI)	4000K	3540lm		
	3000K	6680lm	3400	074-6009
	4000K	7080lm		

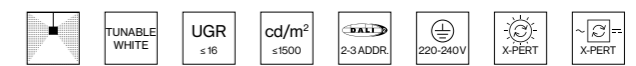

DIRECT / INDIRECT POWER

SYS. POWER	COLOUR TEMP.	LUM. FLUX	L (mm)	ORDER CODE
57W (2×DALI)	3000K	↓ 3350 / ↑ 3790lm	1700	074-6036
109W (3×DALI)	4000K	↓ 3540 / ↑ 4020lm		
	3000K	↓ 6690 / ↑ 7590lm	3400	074-6039
	4000K	↓ 7080 / ↑ 8040lm		
109W (3×DALI)	3000K	↓ 6690lm	3400	074-60D95
	2700–6500K	↑ 6810lm		
109W (3×DALI)	4000K	↓ 7080lm	3400	074-60D96
	2700–6500K	↑ 6810lm		



BLACKBOARD WALLWASHER

SYS. POWER	COLOUR TEMP.	LUM. FLUX	L (mm)	ORDER CODE
48W (1×DALI)	3000K	4940lm	1700	074-7706
	4000K	5100lm		
72W (2×DALI)	3000K	7420lm	3400	074-7719
	4000K	7630lm		
90W (2×DALI)	3000K	9890lm	3400	074-7729
	4000K	10180lm		



BLACKBOARD WALLWASHER / INDIRECT

SYS. POWER	COLOUR TEMP.	LUM. FLUX	L (mm)	ORDER CODE
79W (2×DALI)	3000K	↓ 4940 / ↑ 3780lm	1700	074-7736
	4000K	↓ 5090 / ↑ 4000lm		
127W (3×DALI)	3000K	↓ 7420 / ↑ 7680lm	3400	074-7749
	4000K	↓ 7630 / ↑ 8130lm		
150W (3×DALI)	3000K	↓ 9890 / ↑ 7680lm	3400	074-7759
	4000K	↓ 10180 / ↑ 8130lm		

Accessories

END CAPS

TYPE	ORDER CODE
end caps (pair)	074-609001

LINEAR CONNECTOR

TYPE	ORDER CODE
mechanical linear connector ceiling	074-6091110

CEILING FASTENER / CABLE SUSPENSION / POWER FEEDER

TYPE	L (mm)	ORDER CODE
ceiling fastener	67	050-204121
cable suspension	1500	005-2152110
canopy / feeder cable 5x1.5mm²	1500	005-221241
through wire 5x1.5mm² (10 pieces)		004-90005

more accessories see page 841

Office
Visualisation





Creative Lab Barcelona, ES –
lighting design by MMAS Lighting
tables designed by James Burleigh



F+P Architekten ZT GmbH
Vienna, AT – by F+P Architekten ZT
GmbH with lighting design by Ing.
Gerald Pummer, Illuminazione



Office Inarto Architecten
Herentals, BE – by Inarto Architecten



The art of round efficiency

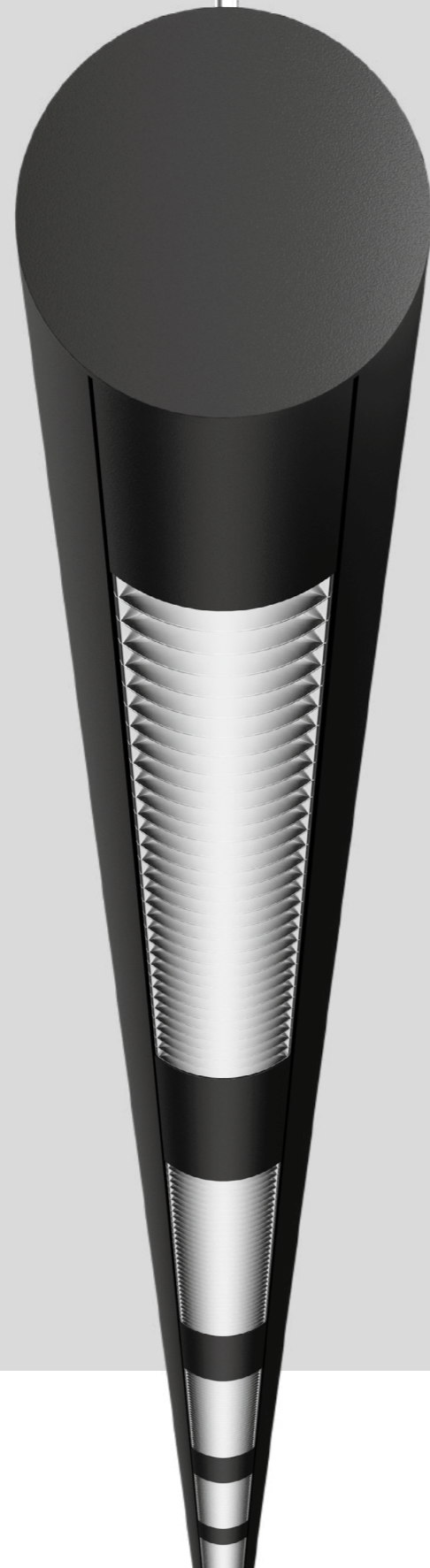

SETA system

EN The SETA system luminaire is perfect for bespoke office needs with a choice of straight or angular elements that can be arranged in any order. The minimalist yet powerful luminaire is available in ceiling-mounted or suspended system versions. Particularly noteworthy are the reflectors optimised for office spaces, which were designed specifically for working on screens. The indirect light component creates a pleasant, homogeneous ceiling illumination for every work area. The SETA System luminaire is also available on request with presence and brightness sensors, and in the light colours 3000 K, 4000 K, and, depending on the version, also in Tunable White.

ES Con elementos rectos o angulares que pueden unirse unos a otros a placer, la luminaria modular SETA es perfecta para satisfacer las necesidades individuales de oficinas. Esta luminaria minimalista a la par que potente está disponible en una variante de superficie para el montaje en techo o como variante modular suspendida. Cabe destacar sobre todo los reflectores optimizados específicamente para dependencias de oficinas, que han sido diseñados especialmente para el trabajo con pantallas de visualización. La proporción de luz indirecta genera una iluminación del techo homogénea y agradable en cualquier zona de trabajo. Opcionalmente, la luminaria modular SETA está disponible con sensores de presencia y luminosidad y en temperaturas de color de 3000 K y 4000 K, así como en Tunable White en algunas variantes.

Types

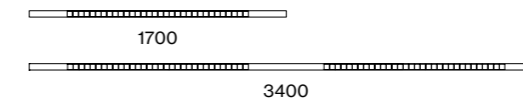

Mountings



ceiling suspended

Configurations

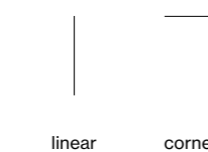

linear corner

Light distributions

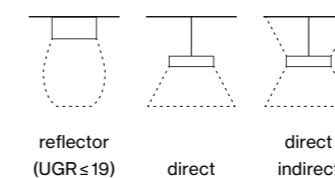

reflector
(UGR ≤ 19) direct direct
indirect

Work-friendly light

EN As an office luminaire, SETA guarantees illumination that is compliant with workplace standards (up to $UGR \leq 16$). Custom glare-free reflectors and the selected use of blind covers direct the light precisely to the work surface and reduce reflections. The direct/indirect version comes with special lens technology that distributes the indirect light component homogeneously and broadly towards the ceiling.

ES Como luminaria de oficina, SETA ofrece una iluminación de puestos de trabajo adaptada a la normativa (hasta $UGR \leq 16$). Unos reflectores especiales exentos de deslumbramiento y el empleo selectivo de cubiertas opacas dirigen la luz con precisión a la superficie de trabajo y reducen los reflejos. En la variante directa/indirecta, una tecnología de lentes especial distribuye una proporción de luz indirecta con un patrón de irradiación muy amplio de manera homogénea en la sala.

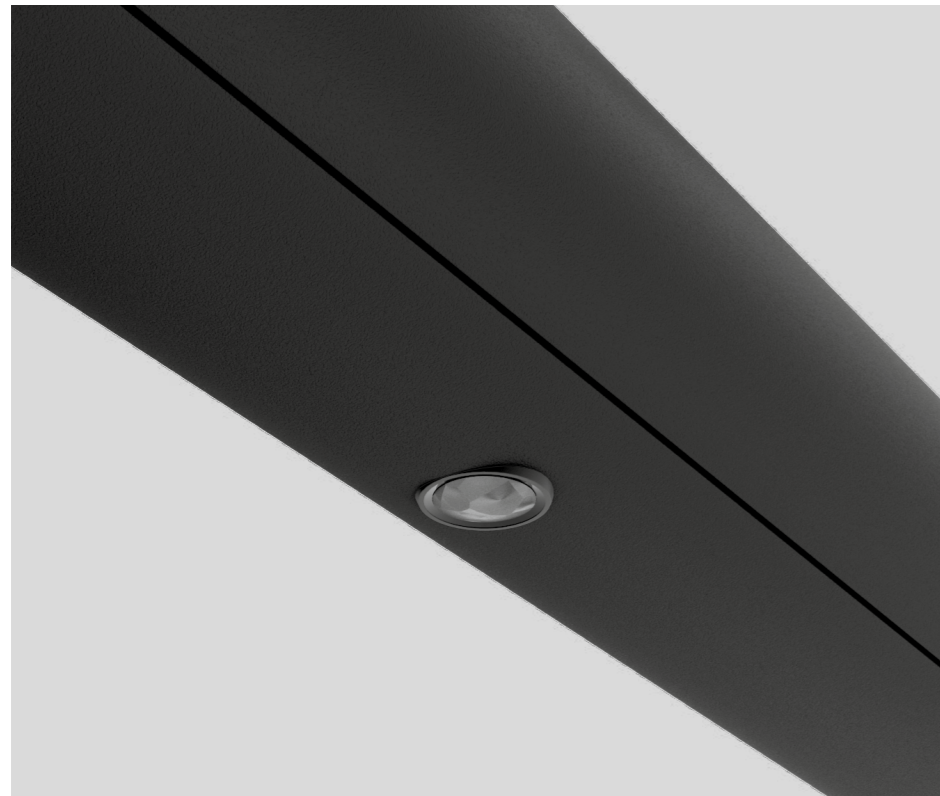

Advanced sensor technology

EN SETA System is equipped with a DALI sensor and can be controlled as a network. A presence sensor controls the light at the workstation depending on whether anyone is in the vicinity. If desks, rooms, or corridors are unoccupied, the light automatically switches off after a defined delay. This saves energy and extends the service life. A brightness sensor adjusts the light intensity to the ambient brightness.

ES Equipada con un sensor DALI, SETA System puede ser controlada a modo de red. Un sensor de presencia regula la iluminación del puesto de trabajo en función de la presencia de una persona, mientras que un sensor de luminosidad adapta la intensidad de la luz a la luminosidad del entorno. Esto permite que la luz se apague automáticamente en escritorios, salas o pasillos vacíos tras un tiempo de espera determinado, lo cual ahorra energía y prolonga la durabilidad de las luminarias.



Lines & edges

EN SETA System comes as a suspended luminaire with straight and angular system elements. Thus, SETA offers a lighting solution that fits into any lighting design concept. Optionally with an indirect light component, the light is distributed homogeneously across the ceiling and creates a pleasant room atmosphere.

ES SETA System está disponible como luminaria de suspensión con elementos modulares angulares y rectilíneos, por lo que SETA ofrece una solución de iluminación que se integra en cualquier esquema de planificación luminotécnica. Con su proporción de luz indirecta opcional, la luz se distribuye en el techo de forma homogénea, generando una atmósfera interior agradable.

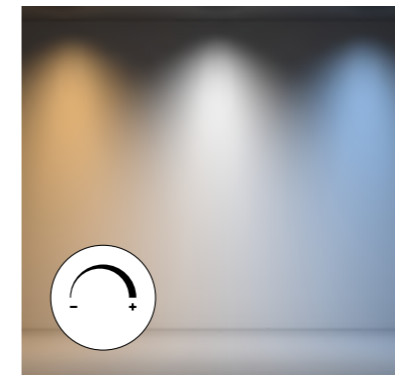

TW – Tunable White

EN Changes in the colour of light have a substantial effect on our mood. Tunable White allows the colour temperature to be continuously adjusted from 2700 K (warm light) to 6500 K (cool light) to dynamically adapt the lighting to the time of day or ambient brightness.

ES Los cambios de color de la luz tienen un efecto considerable en nuestro estado de ánimo. Tunable White hace posible una modificación continua de la temperatura de color desde 2700 K (luz cálida) hasta 6500 K (luz fría), con el fin de adaptar la iluminación de forma dinámica a la hora del día o a la luminosidad del entorno.

Full-spectrum LED

EN XAL's new XPECTRUM LEDs deliver healthy, biologically effective light. The reduced blue light component and increased cyan values reduce the blue light hazard for the eye to daylight-equivalent levels. The resulting non-visual, so-called melanopic light effect, improves concentration and increases sleep quality. The excellent colour rendering of IES TM 30-15 $R_f = 98$ and $R_g = 101$ further helps visual comfort.

ES El nuevo LED XPECTRUM de XAL ofrece una luz saludable con efectos biológicos. La menor proporción de luz azul y el aumento de los valores de cian minimizan el riesgo de la incidencia de luz azul en el ojo, manteniéndola a un nivel similar al presente en la luz natural. El efecto no visible resultante, denominado efecto melanópico, fomenta la concentración y mejora la calidad del sueño. Además, su excelente reproducción cromática –con índices $R_f = 98$ y $R_g = 101$ según la norma IES TM-30-15– garantiza una mayor comodidad visual.

XPECTRUM LED

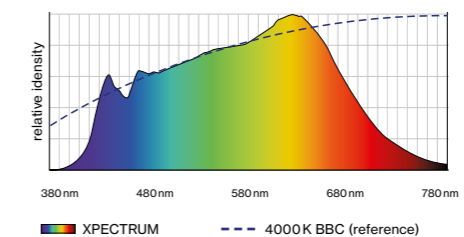

Commercially available LED 4000 K

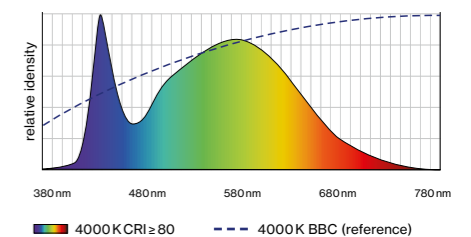

← back

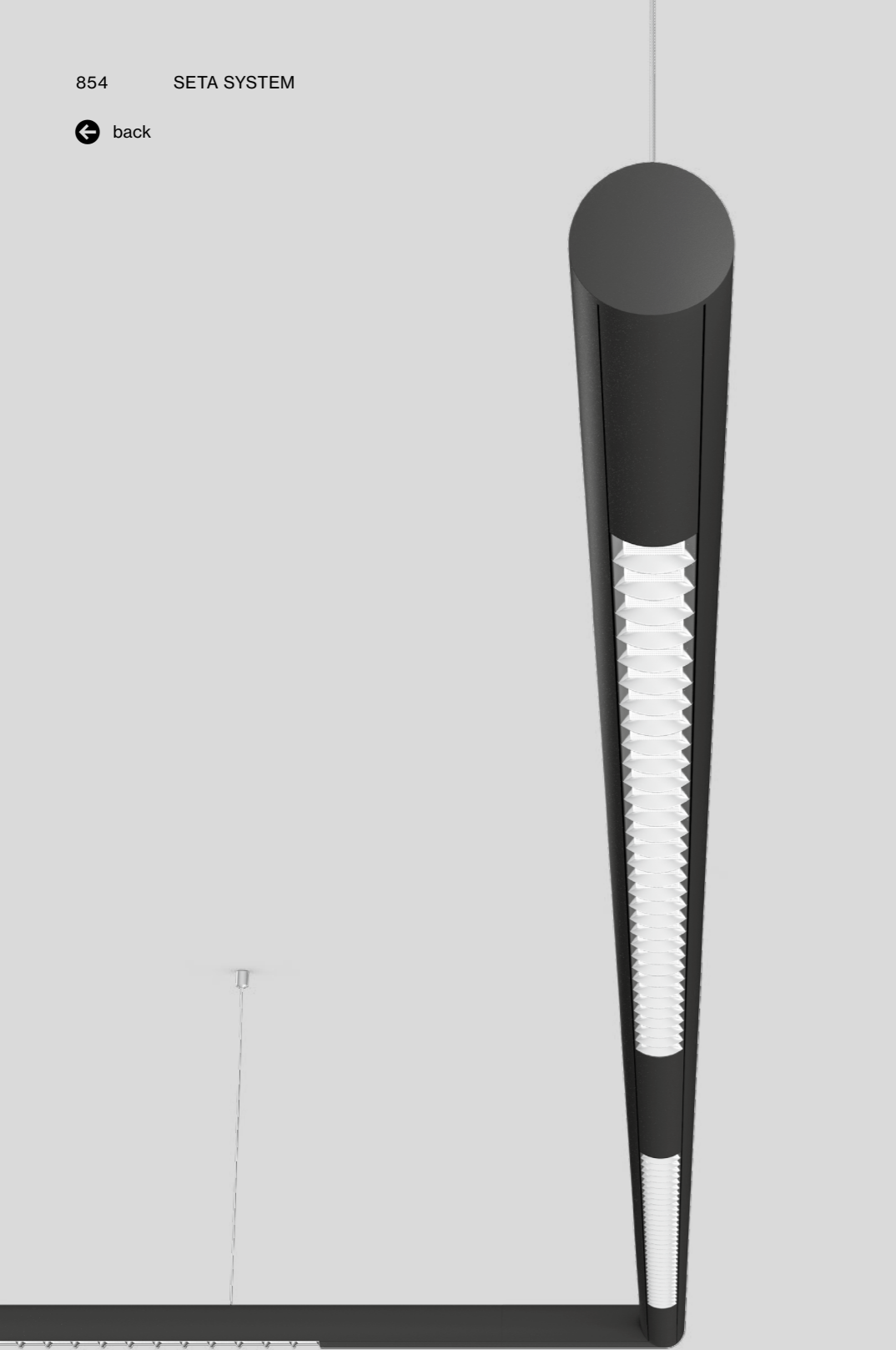

SETA system

ceiling / suspended

EN Luminaire housing from extruded aluminium profile, round design (only $\varnothing 61\text{mm}$); no visible screws; for lighting systems; linear; powder coated; pendant fitting with cable suspension; height adjustment without tools; with transparent feeder cable; extruded profile for improved thermal management; high-gloss reflector with faceted design; direct or direct/indirect light distribution; indirect light component with integrated PC boards and high-quality lens system for max., homog. ceiling illumination, separately controllable; energy-eff. LEDs – very good colour rendering

ES Cuerpo de perfil de aluminio con diseño redondo (solo $\varnothing 61\text{mm}$); sin tornillos visibles; para sistemas de iluminación; lineal; recubierto de polvo; suspendido con cable; altura regulable sin herramientas; incl. cable de alimentación transparente; perfil extruido para una mejor gestión del calor; reflector de alto brillo con óptica facetada; característica de emisión directa o directa/indirecta; componente de luz indir. con plet. propias y ópt. de lente de alta calidad para un alumbr. de techo máx. y homog. con control indep.; LED energético. ef. – excelente reprod. crom.

Quickinfo

3000K, 4000K, TW
 CRI ≥ 80 , 3 SDCM
 UGR ≤ 19 / $65^\circ \leq 1500\text{cd/m}^2$
 L 3400 direct up to 136lm/W
 L 3400 D/I up to 140lm/W
 L90 @ 50 000h
 DALI-2, DALI sensor
 reflector (UGR ≤ 19)

Types

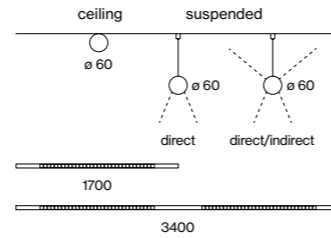

Colours



Light distributions



DiiA® standards
251, 252, 253



special end cap design



corner connector

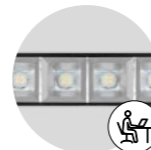

DIN EN 12464-1
UGR ≤ 19

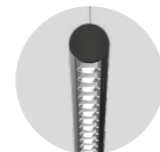

single luminaire
(p.486)

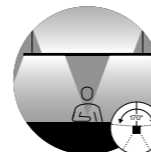

glare-free direct
and 170° indirect
illumination

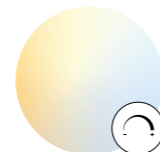

tunable white
2700–6500K

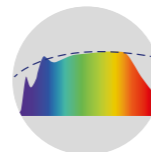

CRI ≥ 98
XPECTRUM

Order options

COLOUR TEMPERATURE	
3000K	5
4000K	6
tunable white 2700–6500K*	
*DALI-2 DT8	

CONTROL	
DALI-2	3
DALI sensor*	7
*brightness & presence only 3400mm	

MATERIAL COLOUR	
white	7
black	8

LIGHT OPTIC COVER	
reflector (UGR ≤ 19)	

Options on request

COLOUR RENDERING INDEX	
CRI ≥ 90	
CRI ≥ 98 XPECTRUM	

MATERIAL COLOUR	
grey	

Light distribution

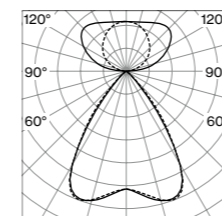

reflector (UGR ≤ 19)
direct/indirect power

LUMINOUS FLUX value calculated for CRI ≥ 80 , colour white, reflector chrome

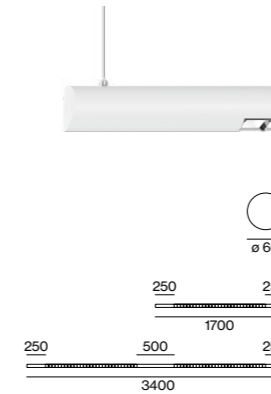
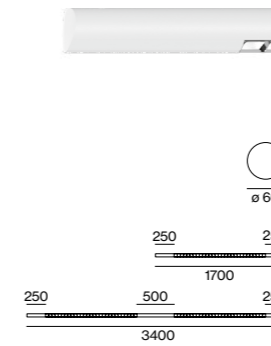

SETA ceiling/suspended system

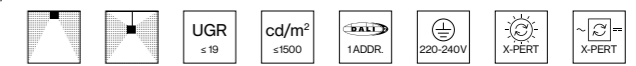

LINEAR DIRECT				
SYS. POWER	COLOUR TEMP.	LUM. FLUX	L (mm)	ORDER CODE
26.1W (1×DALI)	3000K 4000K	3340lm 3540lm	1700	074-5006
52W (2×DALI)	3000K 4000K	6680lm 7080lm	3400	074-5009

SETA suspended system

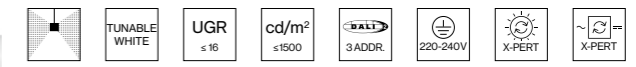

LINEAR DIRECT / INDIRECT POWER				
SYS. POWER	COLOUR TEMP.	LUM. FLUX	L (mm)	ORDER CODE
57W (2×DALI)	3000K 4000K	↓ 3350 / ↑ 3790lm ↓ 3540 / ↑ 4020lm	1700	074-5036
109W (3×DALI)	3000K 4000K	↓ 6690 / ↑ 7590lm ↓ 7080 / ↑ 8040lm	3400	074-5039
109W (3×DALI)	3000K 2700–6500K	↓ 6690lm ↑ 6810lm	3400	074-50D95
109W (3×DALI)	4000K 2700–6500K	↓ 7080lm ↑ 6810lm	3400	074-50D96

Accessories

END CAPS		ORDER CODE
TYPE	end caps (pair)	074-509001

LINEAR CONNECTOR / CORNER CONNECTOR 90°		ORDER CODE
TYPE	mechanical linear connector ceiling	074-5091110
	mechanical linear connector suspended*	074-6091120
	corner connector 90°**	074-509121

* incl. 1500mm cable suspension; ** incl. through wire 5×1.5mm²; order two mechanical linear connectors separately

BLIND COVER		ORDER CODE
TYPE	blind cover 250mm	074-509910
	blind cover 500mm	074-509911

order 1× blind cover 500mm for each linear connector and 1×250mm for each end

CEILING FASTENER		ORDER CODE
TYPE	ceiling fastener	050-204121

CABLE SUSPENSION / CANOPY / THROUGH WIRE		ORDER CODE
TYPE	cable suspension	005-2152110
	canopy / feeder cable 5×1.5mm ²	005-221241
	through wire 5×1.5mm ² (10 pieces)	004-90005

for electrical system configuration see luminaire data sheet at xal.com

Office
Visualisation



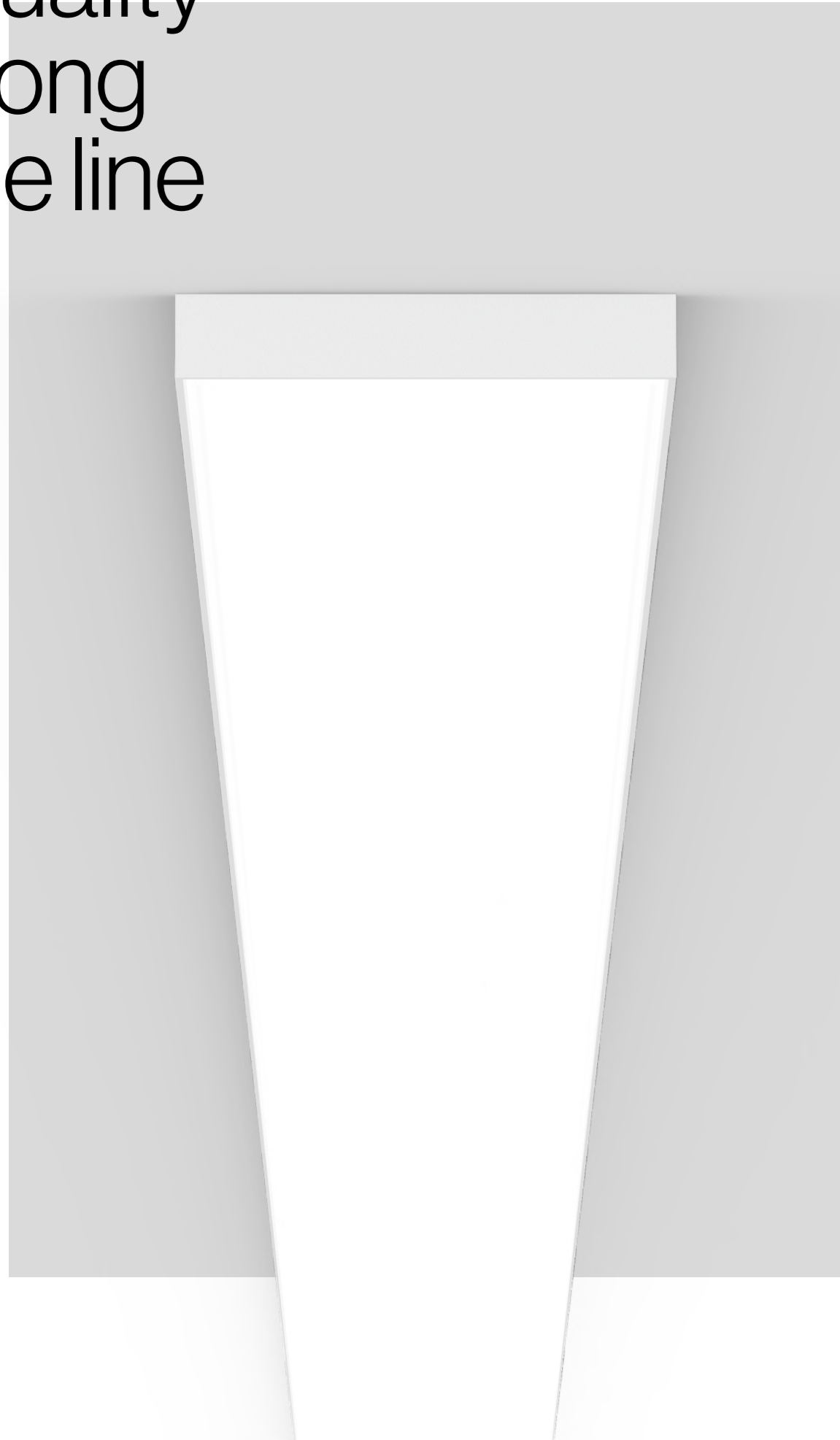

Quality along the line



LENO system

EN The extremely flat LENO profile luminaire is surprisingly versatile. It is available as a recessed, semi-recessed, or surface-mounted version for wall or ceiling mounting, in a suspended version. LENO and its microprismatic cover create ideal work light. The version with an opal cover is best suited for homogeneous room lighting. The variant with asymmetrical beam distribution illuminates walls homogeneously. LENO Jut-Out adds further ceiling illumination by employing discreet lateral radiation. By simply fixing the insets magnetically, assembly is quick and flexible.

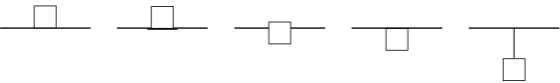
ES La luminaria de perfiles LENO ultraplana sorprende por su versatilidad. Está disponible en variantes empotradas, semiempotradas o de superficie para el montaje en pared o techo y en una variante suspendida. LENO ofrece la mejor luz de trabajo con su difusor microprismático. La variante con cubierta opal es perfecta para un alumbrado general uniforme. La variante con proyección asimétrica ilumina las paredes de forma homogénea, mientras que LENO Jut-Out genera una iluminación adicional del techo gracias a su elegante proyección lateral. El montaje es rápido y flexible, debido a que los insertos se fijan magnéticamente con total facilidad.

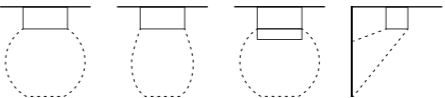
Type	
	90
Mountings	
	trimless recessed trim recessed semi-recessed surface suspended
Configuration	
	linear
Light distributions	
	opal microprismatic (UGR ≤ 19) jut-out wallwasher

Magnetic attachment

EN Simple and utterly tool-free installation: LENO luminaire insets are magnetically fixed in the profile. The patented system saves time and money when installing the luminaire.

ES Montaje sencillo y totalmente sin herramientas: Los cuerpos de las luminarias LENO se fijan magnéticamente al perfil. Este sistema patentado permite ahorrar aún más tiempo y dinero al montar la luminaria.

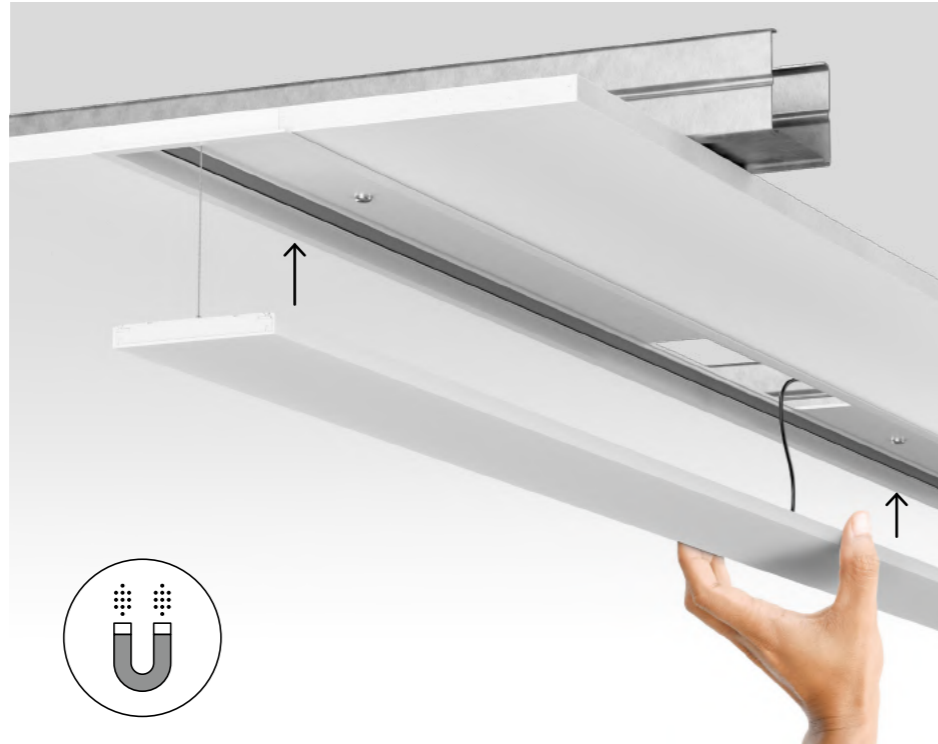

Slim and efficient

EN Innovative lighting technology, minimal profile heights. The extremely flat flush-mounted variants, both with and without a trim, match the height of plasterboard. They are therefore easily mounted on any ceiling, regardless of its substructure. This grants maximum design freedom with a slim appearance and impressive efficiency.

ES Tecnología de iluminación innovadora, alturas de perfil mínimas. Las versiones empotradas ultraplanas, con o sin marco, tienen exactamente la misma altura que una placa de cartón yeso. Eso hace que puedan montarse fácilmente en cualquier techo, independientemente de su estructura de soporte. Numerosas posibilidades de configuración, combinadas con una apariencia esbelta y una eficiencia impresionante.

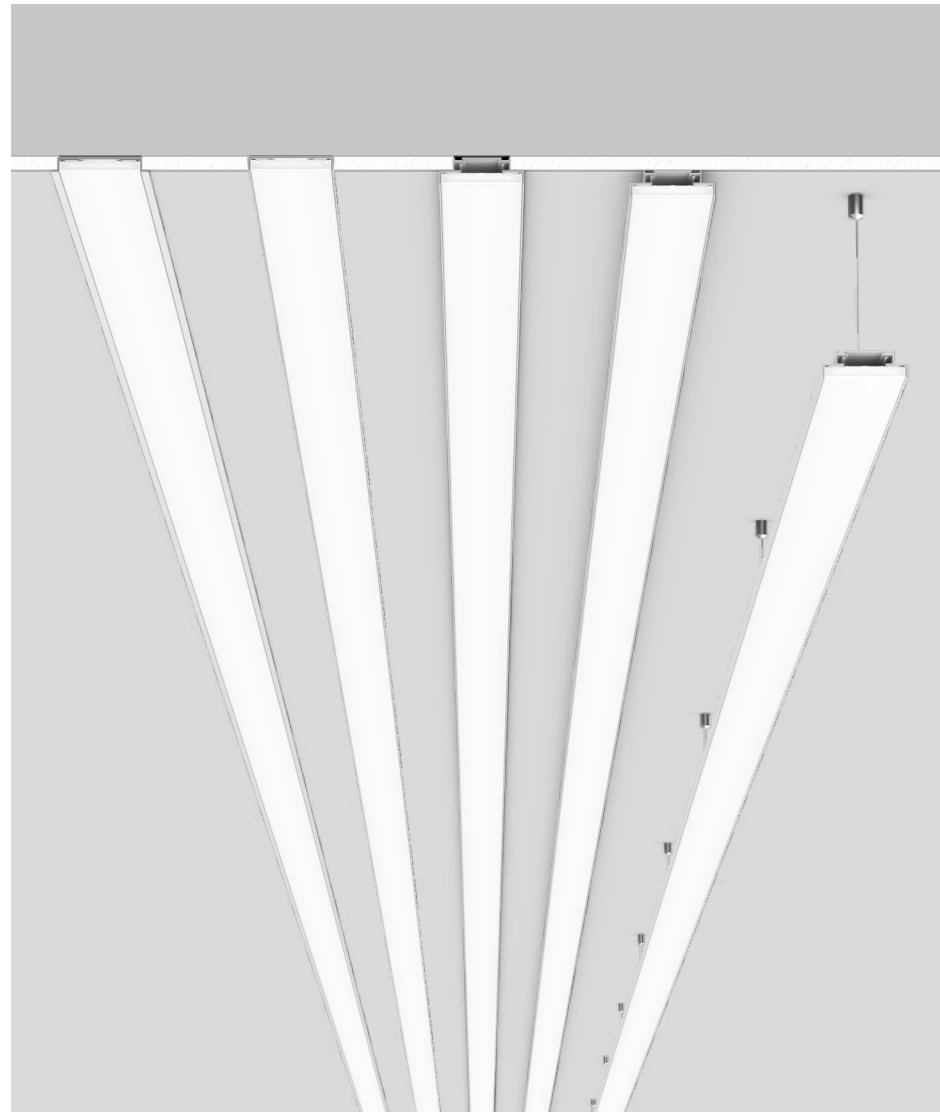
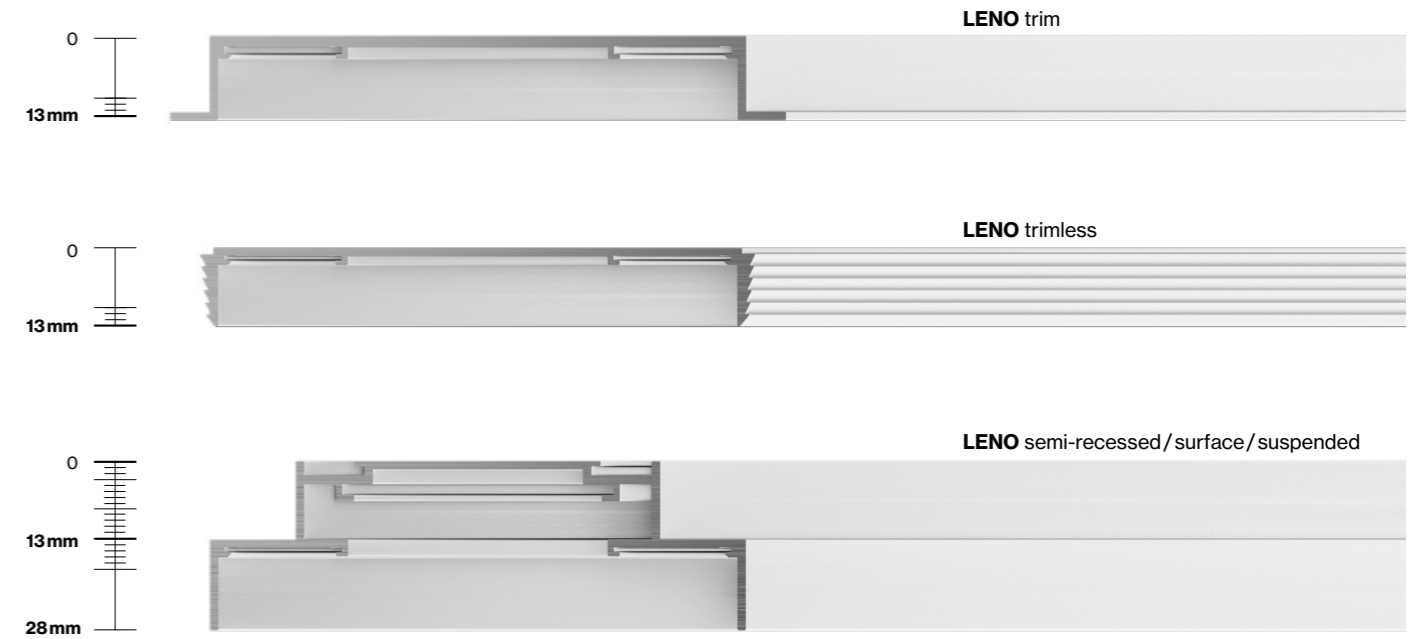

Variety

EN Available for installation in plasterboard ceilings, suspended, or as a surface-mounted variant, this exceptionally flat profile luminaire has precise, homogeneously illuminated edges and can be used in a variety of ways. Choose between the high-performance Opal Cover inset for homogeneous illumination, the workplace-compatible micro-prismatic cover ($UGR \leq 19$) or the opal Jut-Out version for improved room and ceiling illumination. Different lengths and optional asymmetrical light distribution complete the range.

ES Ya sea para el empotramiento en techos de yeso, la instalación suspendida o en su versión de montaje en superficie, esta luminaria de perfil extremadamente plano está dotada de bordes precisos e iluminados de manera homogénea y admite una gran cantidad de usos. En cuanto a los difusores, es posible elegir entre la High Performance Opal Cover para un alumbrado homogéneo, el difusor microprismático apto para puestos de trabajo ($UGR \leq 19$) o la versión opal Jut-Out para una mejor iluminación de la sala y el techo. Diversas longitudes y una distribución de la luz asimétrica opcional completan la gama de opciones.

Single or system

EN LENO is flexible and available in four lengths, and as a system luminaire in any length. Depending on requirements, the elements are simply mechanically connected – tailored to match the design of the interior. LENO can create a particularly powerful, continuous lighting system, granting maximum freedom of design.

ES LENO es sinónimo de flexibilidad y está disponible en cuatro longitudes distintas como, o en la longitud que se desee en su variante de sistema. Los elementos se combinan mecánicamente con toda facilidad en función de los requisitos, adaptándolos individualmente al diseño del interior. Con LENO es posible crear un sistema de iluminación continuo y extremadamente efectivo que permite disponer de innumerables opciones de configuración.



← back



LENO system

recessed with trim

EN Low profile recessed channel; suitable for installation in 12.5mm ceilings, with trim; suitable for wall or ceiling mounting; for continuous lighting systems; surface powder coated; easy mounting without need to cut the substructure; fall-safe light inset made of extruded aluminium profile, can be inserted in the canal without tools by magnetic holders; side coupled light, directed downwards by LGP body (Light Guiding Prism) and highly efficient reflector; homogeneously illuminated, satinised (flush or jut-out) or microprismatic PMMA cover; optional with asymmetric light distribution; energy-eff. LEDs – very good colour rendering; incl. external converter for ceiling insertion

ES Canal para montaje empotrado extremadamente plano; apropiado para montaje en techos de 12,5mm, con borde de contorno; apropiado para el montaje en la pared y en el techo; para sistemas de iluminación continuos; superficie con recubrimiento de pintura en polvo; montaje sencillo sin cortar la construcción inferior; elemento de luz asegurado contra caídas de perfil de aluminio extrusionado que se puede introducir en el canal sin herramientas por medio de un soporte magnético; fuente de luz insertada en un lateral que es guiada y reflectada a través de unos prismas y reflector de alta calidad; cubierta de PMMA iluminada homogéneamente, satinada (enrasada o sobresaliente) o micro-prismática; opcional con distribución asimétrica; LED energét. efíc. – excelente reprod. crom.; incl. convertidor externo para inserción en el techo

Quickinfo

3000K, 4000K
 CRI ≥ 80, 3 SDCM
 up to 137lm/W
 L90 @ 50 000h
 DALI-2
 opal, microprismatic (UGR ≤ 19),
 jut-out, asymmetric wallwasher

Types

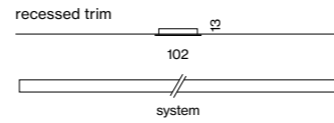

Colour



Light distributions



Order options

COLOUR TEMPERATURE	
3000K	5
4000K	6

CONTROL

DALI-2

MATERIAL COLOUR

○ traffic white RAL 9016

LIGHT OPTIC COVER

opal high performance	H
microprismatic (UGR ≤ 19)	G
jut-out	J
asymmetric	A

Options on request

COLOUR RENDERING INDEX

CRI ≥ 90

EMERGENCY LIGHT

1h accupack
 3h accupack

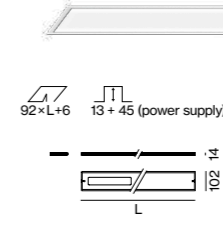

LENO trim

INSTALLATION CHANNEL

TYPE	L (mm)	ORDER CODE
channel	613	051-8910067
channel	1221	051-8910127
channel	1830	051-8910187
channel	2438	051-8910247

order installation channel, light inset + mounting accessories separately



LIGHT INSET

SYS. POWER (OPAL, MP, JUT-OUT / ASYM.)	L (mm)	ORDER CODE
10.8W/15.6W	612	051-8012370
19.1W/31W	1220	051-8014370
28.6W/47W	1828	051-8016370
38W/62W	2436	051-8018370

COVER	COLOUR TEMP.	SYSTEM POWER	DELIVERED LUMENS	EFFICACY
opal high	3000K	17.6 W/m	2010 lm/m	129 lm/W
performance	4000K		2130 lm/m	137 lm/W
microprismatic	3000K	17.6 W/m	1900 lm/m	122 lm/W
UGR ≤ 19	4000K		2010 lm/m	129 lm/W
jut-out	3000K	17.6 W/m	1930 lm/m	124 lm/W
	4000K		2040 lm/m	131 lm/W
asymmetric	3000K	25.5 W/m	2580 lm/m	101 lm/W
	4000K		2730 lm/m	107 lm/W

Accessories



END CAPS

TYPE	ORDER CODE
end caps (pair)	051-8991217



LINEAR CONNECTOR

TYPE	ORDER CODE
linear connector (pair)	051-8990110
linear connector (10 pairs)	051-8990110.10



DISMOUNTING TOOL

TYPE	ORDER CODE
vacuum cup	086-30000

Light distribution

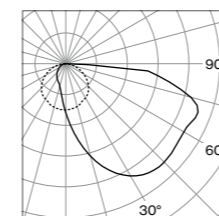

asymmetric

LUMINOUS FLUX value calculated for colour white, cover opal microprismatic -5%, jut-out-4%

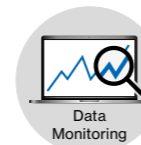

DiiA® standards
 251, 252, 253



single luminaire
 (p. 492)

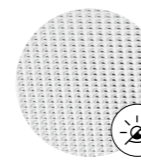

microprismatic
 UGR ≤ 19



quick
 installation

Technical data

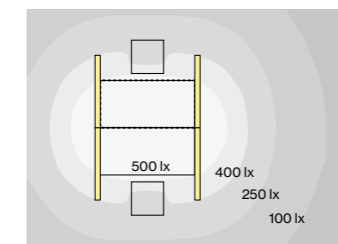

LENO trim, microprismatic,
 19.1W, 4000K

ROOM VALUES	
Room dimensions	5.4 × 4 × 2.8m
Reflection factor	0.7 0.5 0.2
Maintenance factor	0.8

CALCULATION SURFACE	
Surface dimensions	1.6 × 0.8
Surface height	0.75
Average illuminance (E _m)	> 500 lx
Uniformity (U ₀)	> 0.6

GLARE EVALUATION	
Table Classification X=4H Y=8H S=0.25H	
UGR transversal	≤ 19
UGR axial	≤ 19

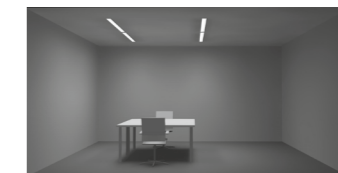



Vaucluse House Sydney, AU –
by EST Lighting



**Office Gemüsekiye**

Kramsach, AT –

by STUDIODESIGN, Herbert Lanzinger KG





Jungheinrich Hauptverwaltung
Hamburg, DE –
by reichardt+partner architekten



Sharpen your profile system

MINIMAL system

EN A minimalist, continuous lighting system with maximum design freedom – MINIMAL makes this combination possible. The system luminaire is rimless, can be varied in length and thus be individually combined. CORNER elements create the perfect connection between the individual system luminaires. Designed for indoor use, the microprismatic cover version offers a standard-compliant reduced glare value for ideal workplace lighting. When using the opal cover, homogeneous room illumination is achieved, whereas the wallwasher insert provides uniform wall illumination. The MINIMAL system luminaire is available in the light colours 3000K, 4000K, and optionally in Tunable White.

ES MINIMAL hace posible la combinación de un sistema de iluminación continuo y minimalista con la máxima libertad de diseño. La luminaria modular no tiene bordes y es de longitud variable, por lo que puede combinarse individualmente. Los elementos CORNER posibilitan la unión perfecta entre las distintas luminarias modulares. Concebida para interiores, la variante con difusor microprismática ofrece un índice de deslumbramiento reducido adaptado a la normativa para una iluminación perfecta de puestos de trabajo. El uso del difusor opal permite lograr un alumbrado general homogéneo. Por su parte, el inserto bañador de luz garantiza una iluminación uniforme de paredes. La luminaria modular MINIMAL está disponible en temperaturas de color de 3000K, 4000K y, opcionalmente, Tunable White.

Types



60

100

Mounting



trimless
recessed

Configurations



linear

corner

Light distributions

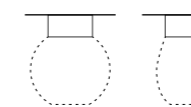

opal

microprismatic
(UGR ≤ 19)

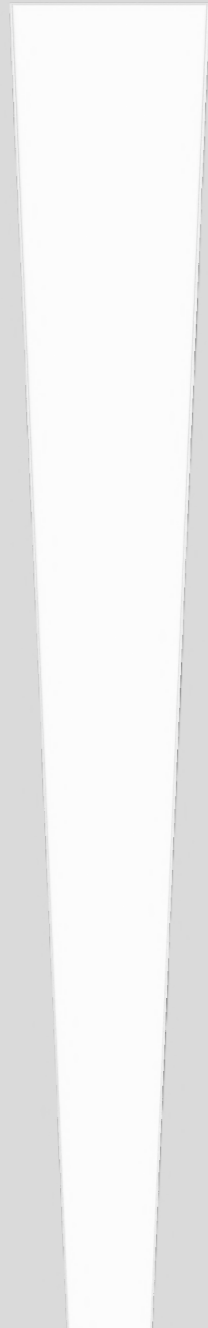
[← back](#)

MINIMAL 100 system

recessed trimless

EN Luminaire housing made of extruded aluminium; for trimless installation in plasterboard ceilings; special edge design with grooves for better adhesion of filler; for continuous lighting systems; for ceiling thickness of 8-25mm; surface powder coated; luminaire profile for mounting available in advance; remaining components mounted without tools; light inset consisting of highly reflective coated extruded profile for improved thermal management; option: lighting module is versatile in length; HPO (High Performance Opal) cover for uniform illumination; micro prismatic PMMA diffuser incl. diffuser film for homogeneous illumination and reduced luminance; wallwasher light inset; energy-eff. LEDs – very good colour rendering

ES Cuerpo de lámpara de perfil extrusionado de aluminio; para montaje sin marco en techos de yeso; con diseño especial en los bordes para facilitar una mejor fijación del producto; para sistemas de iluminación continuos; para espesores de techo de 8-25mm; superficie con recubrimiento de pintura en polvo; Perfil disponible para pre-montaje; los demás componentes se pueden montar sin herramientas; elemento de luz formado por perfil extruido con acabado altamente reflectante para una gestión térmica mejorada; elemento de luz opcional recortable a discreción; difusor opal de alta calidad que proporciona una iluminación uniforme; cubierta microprismática de PMMA con lámina difusora para la reducción de iluminancia y un alumbrado homogéneo; inserto bañador de pared; LED energét. efic. – excelente reprod. crom.

Quickinfo

3000K, 4000K, TW
 CRI \geq 80, CRI \geq 90, 3 SDCM
 UGR \leq 19 / 65° \leq 3000cd/m²
 up to 3090lm/m
 up to 140lm/W
 L90 @ 50 000h
 non DIM, DALI-2
 opal, microprismatic (UGR \leq 19)

Types

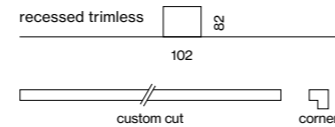

Colour



Light distributions



microp. opal



Data Monitoring
 DiiA® standards
 251, 252, 253



single luminaire
 (p.512)

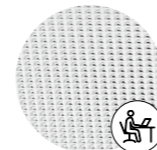

DIN EN 12464-1
 UGR \leq 19



wallwasher
 inset (p.944)

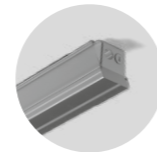

concrete install.
 housing (p.946)

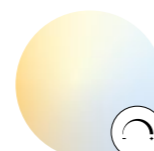

tunable white
 2700–6500K

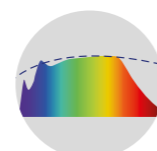

CRI \geq 98
 XPECTRUM

Order options

LED TYPE	
mid lumen	L
high lumen	M

COLOUR TEMPERATURE	
3000K (CRI \geq 90)	0
4000K (CRI \geq 90)	1
3000K (CRI \geq 80)	5
4000K (CRI \geq 80)	6
tunable white 2700–6500K*	

*DALI-2 DT8

CONTROL	
non DIM	1
DALI-2 (only high lumen)	3

MATERIAL COLOUR

○ traffic white RAL 9016

LIGHT OPTIC COVER

opal high performance	H
microprismatic	Z
microprismatic (UGR \leq 19)*	G
blind cover**	B

*UGR \leq 19 only with mid lumen

**only for channel corner 90°

EMERGENCY LIGHT

1h Accupack	N L 1
3h Accupack	N L 3

Options on request

COLOUR RENDERING INDEX

CRI \geq 98 XPECTRUM

MINIMAL 100 trimless

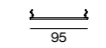
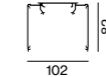
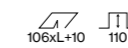

INSTALLATION CHANNEL / CORNER 90°

TYPE	L (mm)	ORDER CODE
channel	1172	036-01267
channel	1472	036-01567
channel	3000	036-03067
channel	custom	E 8 2 0 5 0 ···· 7
channel corner 90° + cover	200x200	036-12667 □

LIGHT OPTIC COVER / BLIND COVER

TYPE	L (mm)	ORDER CODE
linear	1171	006-12122 □
linear	1470	006-12152 □
linear	2997	006-12302 □
linear	custom	E 8 0 6 5 0 ···· 0 □
blind cover	3000	006-11307
blind cover	custom	E 8 0 6 5 0 ···· 7 B



LIGHT INSET 100

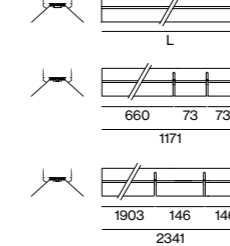

SYSTEM POWER (MID/HIGH LUMEN)	L (mm)	ORDER CODE
8.7/13.8W	571	007-86 2 :: ∇
13/20.6W	871	007-86 3 :: ∇
15.3/27.5W	1171	007-86 4 :: ∇
19.2/34W	1463	007-86 5 :: ∇ ●
31/55W	2341	007-86 8 :: ∇
38/68W	2997	007-86 9 :: ∇
flexible inset 15.3/27.5W	660-1171	007-86 F :: ∇
flexible inset 31/55W	1903-2341	007-86 G :: ∇

COVER	COLOUR TEMP.	SYSTEM POWER	DELIVERED LUMENS	EFFICACY
mid lumen/opal	3000K	14 W/m	1770lm/m	132lm/W
high performance	4000K		1870lm/m	140lm/W
high lumen/opal	3000K	24 W/m	2920lm/m	123lm/W
high performance	4000K		3090lm/m	130lm/W

LIGHT INSET 100 tunable white 2700–6500K

SYSTEM POWER	L (mm)	ORDER CODE
21.7W	871	007-8633D37
29W	1171	007-8634D37
36W	1463	007-8635D37
58W	2341	007-8638D37

Accessories

END CAPS

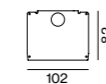

TYPE	ORDER CODE
end caps (pair)	036-13067

LINEAR CONNECTOR / THROUGH WIRE

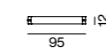
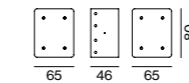

TYPE	ORDER CODE
linear connector (1 piece)	005-40066
linear connector (10 pieces)	005-40066.10
opal cover linear connector	006-10000
through wire 3 × 1.5 mm ² (non DIM, 10 pieces)	004-90003
through wire 5 × 1.5 mm ² (DALI-2, 10 pieces)	004-90005

MOUNTING BRACKET

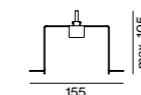

TYPE	CEILING THICKNESS (mm)	ORDER CODE
mounting bracket (1 piece)	8-25	036-10300
mounting bracket (25 pieces)	8-25	036-10300.25

number of brackets required: length of your system in metres+1

LUMINOUS FLUX value calculated for
 CRI \geq 80, colour white, cover opal
 microprism. Z -8%, microprism. G -10%

Bank of Ireland Dublin, IE –
by Henry J Lyons Architects with lighting
design by O'Connor Sutton Cronin





Telecable
Gijón, ES –
by Arquitectos
Pablo Poch Duo Comunicación with
lighting design by Lux Gijón



Outline your profile system

FRAME system

EN The FRAME system luminaire sets no limits on office lighting and profile-based ambient lighting. Thanks to special flex insets, FRAME can be shortened on-site and thus adapted to all conditions. The system luminaire connects to form a light band, creating continuous lighting. Corner connectors thus create a continuous lighting system. The lighting insets also leave nothing to be desired – whether insets with opal cover for uniform room illumination, or the microprismatic cover for light suitable for workplaces. Available light colours range from 3000 K to 4000 K and optional Tunable White, and a colour rendering of up to $CRI \geq 98$ (XPECTRUM).

ES La luminaria modular FRAME satisface cualquier necesidad en las áreas de la iluminación de oficina y del alumbrado general con sistemas de perfiles. Gracias a sus insertos Flex especiales, FRAME puede acortarse en el propio lugar de instalación y adaptarse así a cualquier circunstancia. La luminaria modular puede unirse en forma de banda luminosa creando un alumbrado ininterrumpido. Los conectores de esquinas hacen posible la obtención de un sistema de iluminación continuo. Los insertos luminosos también satisfacen cualquier requisito, cubiertos con un difusor opal para un alumbrado interior uniforme o dotados de una cubierta microprismática para una iluminación adaptada a puestos de trabajo. En el área de la temperatura de color puede elegirse entre 3000K, 4000K y, opcionalmente, Tunable White. Por su parte, la reproducción cromática alcanza un índice IRC ≥ 98 (XPECTRUM).

Types



40

60

100

Mounting



with trim
recessed

Configurations



linear

corner

Light distributions

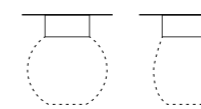

opal

 microprismatic
($UGR \leq 19$)

← back



FRAME 40 system

recessed with trim

EN Luminaire housing made of extruded aluminium; recessed luminaire with trim; designed for continuous lighting systems; suitable for ceiling thickness of 8-25mm; surface powder coated; luminaire profile incl. light inset; cover in the length of the light inset or continuous cover (both separately available); pre-assembled power rail for power supply in luminaire profile; voltage tap of the light inset on the power rail; light inset consisting of highly reflective coated extruded profile for improved thermal management; HPO (High Performance Opal) cover for uniform illumination; energy-efficient LEDs with very good colour rendering

ES Cuerpo de lámpara de perfil extrusionado de aluminio; luminaria empotrable con marco; diseñado para la creación de sistemas continuos; apropiada para grosores de techo entre 8-25mm; superficie con recubrimiento de pintura en polvo; perfil de lumin. con inserto lumin.; difusor en longitud de inserto luminoso o continuo (ambos deben encargarse por separado); carril eléctrico premont. para suministro de corr. en perfil de lumin.; toma de corr. para inserto lumin. en carril eléctrico; elemento de luz formado por perfil extruido con acabado altamente reflectante para una gestión térmica mejorada; difusor opal de alta calidad que proporciona una iluminación uniforme; LEDs de alta eficiencia que proporcionan una alta reproducción cromática

Quickinfo

3000K, 4000K
CRI ≥ 90, 3 SDCM
up to 2340lm/m
up to 102lm/W
L90 @ 50 000h
DALI-2
opal

Types

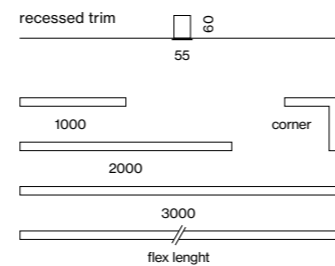

Colours



Light distribution



DiiA® standards
251, 252, 253



single luminaire
(p. 518)

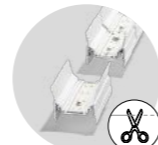

flexible
inset

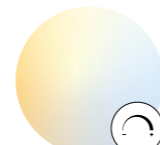

tunable white
2700–6500K

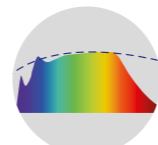

CRI ≥ 98
XPECTRUM

Order options

LED TYPE	
mid lumen	1
high lumen	2

COLOUR TEMPERATURE	
3000K	0
4000K	1

CONTROL	
DALI-2	

MATERIAL COLOUR	
<input type="radio"/> traffic white RAL 9016	7
<input checked="" type="radio"/> white aluminium RAL 9006	G

LIGHT OPTIC COVER	
opal high performance	

Options on request

COLOUR RENDERING INDEX	
CRI ≥ 98 XPECTRUM	

COLOUR TEMPERATURE	
tunable white 2700–6500K	

LIGHT OPTIC COVER	
microprismatic	

FRAME 40 trim

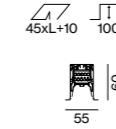

INSTALLATION CHANNEL + LIGHT INSET

SYSTEM POWER (MID/HIGH LUMEN)	L (mm)	ORDER CODE
15.3/22.9W	1000	042-70▲2::3
30.5/46W	2000	042-70▲4::3
46/69W	3000	042-70▲6::3
15.3/22.9W flex	500–1000	042-70▲F::3
30.5/46W flex	1500–2000	042-70▲G::3
15.3/22.9W corner	500×500	042-70▲C::3

COVER	COLOUR TEMP.	SYSTEM POWER	DELIVERED LUMENS	EFFICACY
mid lumen/opal	3000K	15.3W/m	1480lm/m	97lm/W
high performance	4000K		1560lm/m	102lm/W
high lumen/opal	3000K	22.9W/m	2210lm/m	97lm/W
high performance	4000K		2340lm/m	102lm/W

LIGHT OPTIC COVER 40

TYPE	L (mm)	ORDER CODE
linear	1000	006-4210010H
linear	2000	006-4220010H
linear	3000	006-4230010H
corner	500×500	006-4205020H
continuous linear	6000	006-2206010H
continuous linear	30000	006-2230010H

Accessories

END CAPS

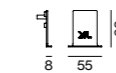

TYPE	ORDER CODE
end caps (pair)	042-709001

CHANNEL + BLIND COVER

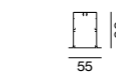

TYPE	L (mm)	ORDER CODE
linear	1000	042-709421
linear	2000	042-709441
linear	3000	042-709461
corner	500×500	042-7094C1

POWER FEEDER UNIT

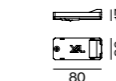

TYPE	ORDER CODE
power feeder unit	042-1093230

LINEAR CONNECTOR

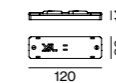

TYPE	ORDER CODE
mechanical linear connector	042-7091110
mechanical + electrical linear connector	042-7091230
opal cover linear connector	042-1091910

MOUNTING BRACKET

TYPE	CEILING THICKNESS (mm)	ORDER CODE
mounting bracket (1 piece)	8-25	042-7092110
mounting bracket (25 pieces)	8-25	042-7092110.25

number of brackets required: length of your system in metres+1

LUMINOUS FLUX value calculated for
CRI ≥ 90, colour white, cover opal

← back

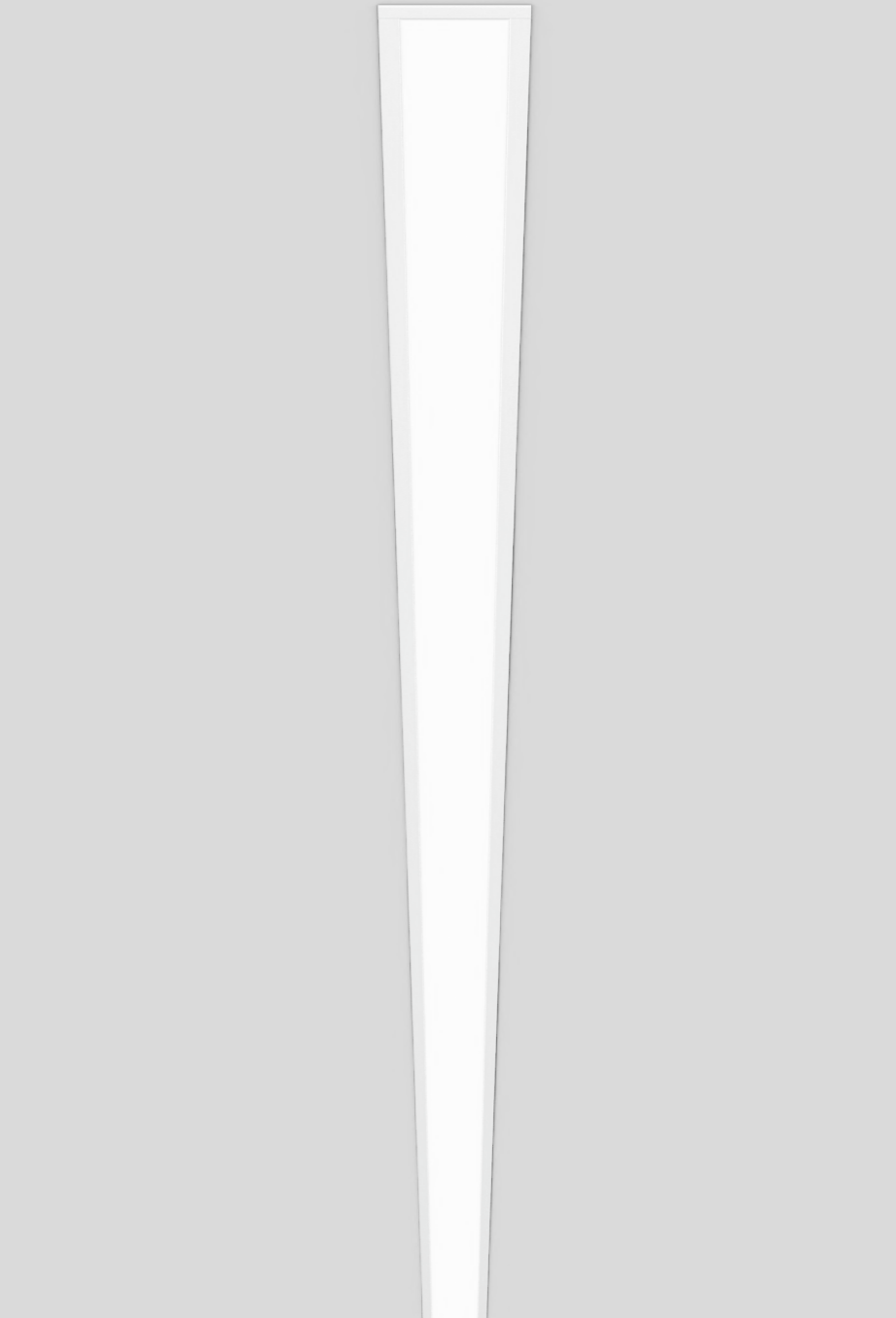

FRAME 60 system

recessed with trim

EN Luminaire housing made of extruded aluminium; recessed luminaire with trim; designed for continuous lighting systems; suitable for ceiling thickness of 8-25 mm; surface powder coated; luminaire profile for mounting available in advance; remaining luminaire components mounted without tools; light inset consisting of highly reflective coated extruded profile for improved thermal management; option: lighting module is versatile in length; HPO (High Performance Opal) cover for uniform illumination; micro prismatic PMMA diffuser incl. diffuser film for homogeneous illumination and reduced luminance; wall-washer light inset; energy-efficient LEDs with very good colour rendering

ES Cuerpo de lámpara de perfil extrusionado de aluminio; luminaria empotrable con marco; diseñado para la creación de sistemas continuos; apropiada para grosos de techo entre 8-25 mm; superficie con recubrimiento de pintura en polvo; Perfil disponible para pre-montaje; resto de componentes luminosos montables sin herramienta; elemento de luz formado por perfil extruido con acabado altamente reflectante para una gestión térmica mejorada; elemento de luz opcional recortable a discreción; difusor opal de alta calidad que proporciona una iluminación uniforme; cubierta microprismática de PMMA con lámina difusora para la reducción de iluminancia y un alumbrado homogéneo; inserto bañador de pared; LEDs de alta eficiencia que proporcionan una alta reproducción cromática

Quickinfo

3000K, 4000K, TW
CRI ≥ 80, CRI ≥ 90, 3 SDCM
up to 2760 lm/m
up to 125 lm/W
L90 @ 50 000h
non DIM, DALI-2
opal, microprismatic (UGR ≤ 19)

Types

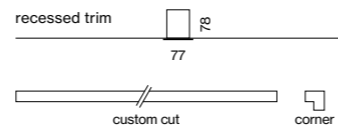

Colours



Light distributions

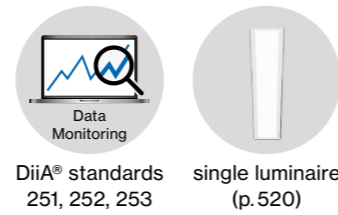

DiiA® standards
251, 252, 253

single luminaire
(p. 520)



wallwasher
inset (p. 944)

concrete install.
housing (p. 946)

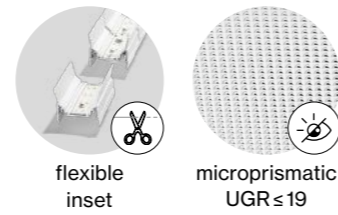

flexible
inset

microprismatic
UGR ≤ 19

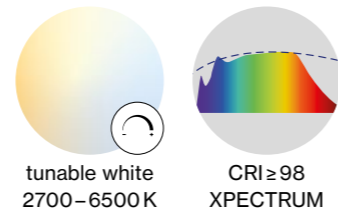

tunable white
2700–6500 K

CRI ≥ 98
XPECTRUM

Order options

LED TYPE	
mid lumen	L
high lumen	M

COLOUR TEMPERATURE	
3000 K (CRI ≥ 90)	0
4000 K (CRI ≥ 90)	1
3000 K (CRI ≥ 80)	5
4000 K (CRI ≥ 80)	6
tunable white 2700–6500 K*	

*DALI-2 DT8

CONTROL	
non DIM	1
DALI-2 (only high lumen)	3

MATERIAL COLOUR	
○ traffic white RAL 9016	7
● white aluminium RAL 9006	G

LIGHT OPTIC COVER	
opal high performance	H
microprismatic	Z
microprismatic (UGR ≤ 19)*	G
blind cover**	B

*UGR ≤ 19 only with mid lumen
**only for channel corner 90°

EMERGENCY LIGHT	
1h Accupack	N L 1
3h Accupack	N L 3

Options on request

COLOUR RENDERING INDEX	
CRI ≥ 98 XPECTRUM	

INSTALLATION CHANNEL	
curve	

CONNECTOR	
X- and T-connector	

LUMINOUS FLUX value calculated for
CRI ≥ 80, colour white, cover opal
microprismatic -13%

FRAME 60 trim

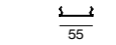
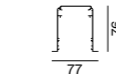
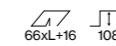

INSTALLATION CHANNEL / CORNER 90°	L (mm)	ORDER CODE
channel	1172	035-0123
channel	1472	035-0153
channel	3000	035-0303
channel	custom	E 82 1 40
channel corner 90° + cover	144x144	035-1263

LIGHT OPTIC COVER / BLIND COVER	L (mm)	ORDER CODE
linear	1171	006-16122
linear	1470	006-16152
linear	2997	006-16302
linear	custom	E 80 6 30
continuous linear	6000	006-23061H
continuous linear	25000	006-23251H
blind cover	3000	006-1830
blind cover	custom	E 80 6 30

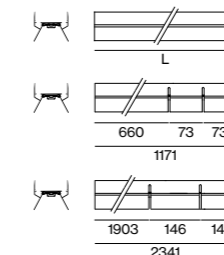

LIGHT INSET 60	L (mm)	ORDER CODE
SYSTEM POWER (MID/HIGH LUMEN)		
8.7 / 13.8 W	571	007-93 2
13 / 20.6 W	871	007-93 3
15.3 / 27.5 W	1171	007-93 4
19.2 / 34 W	1463	007-93 5
31 / 55 W	2341	007-93 8
38 / 68 W	2997	007-93 9
flexible inset 15.3 / 27.5 W	660-1171	007-93 F
flexible inset 31 / 55 W	1903-2341	007-93 G

COVER	COLOUR TEMP.	SYSTEM POWER	DELIVERED LUMENS	EFFICACY
mid lumen / opal	3000 K	14 W/m	1540 lm/m	118 lm/W
high performance	4000 K		1640 lm/m	125 lm/W
high lumen / opal	3000 K	24 W/m	2540 lm/m	110 lm/W
high performance	4000 K		2700 lm/m	116 lm/W

LIGHT INSET 60 tunable white 2700–6500 K	L (mm)	ORDER CODE
SYSTEM POWER		
21.7 W	871	007-9333D37
29 W	1171	007-9334D37
36 W	1463	007-9335D37
58 W	2341	007-9338D37

Accessories

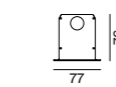

END CAPS	ORDER CODE
TYPE	
end caps (pair)	035-1313

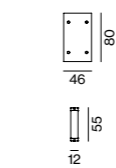

LINEAR CONNECTOR / THROUGH WIRE	ORDER CODE
TYPE	
linear connector (1 piece)	005-40046
linear connector (10 pieces)	005-40046.10
opal cover linear connector	006-14000
through wire 3 × 1.5 mm ² (non DIM, 10 pieces)	004-90003
through wire 5 × 1.5 mm ² (DALI-2, 10 pieces)	004-90005

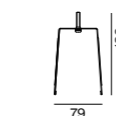

MOUNTING BRACKET	CEILING THICKNESS (mm)	ORDER CODE
TYPE		
mounting bracket (1 piece)	8-25	035-10200
mounting bracket (25 pieces)	8-25	035-10200.25

number of brackets required: length of your system in metres+1



Dr. Schaer Burgstall, IT –
by monovolume architecture+design
with lighting design by VON LUTZ -
electrical and lighting projects /
Alexa von Lutz

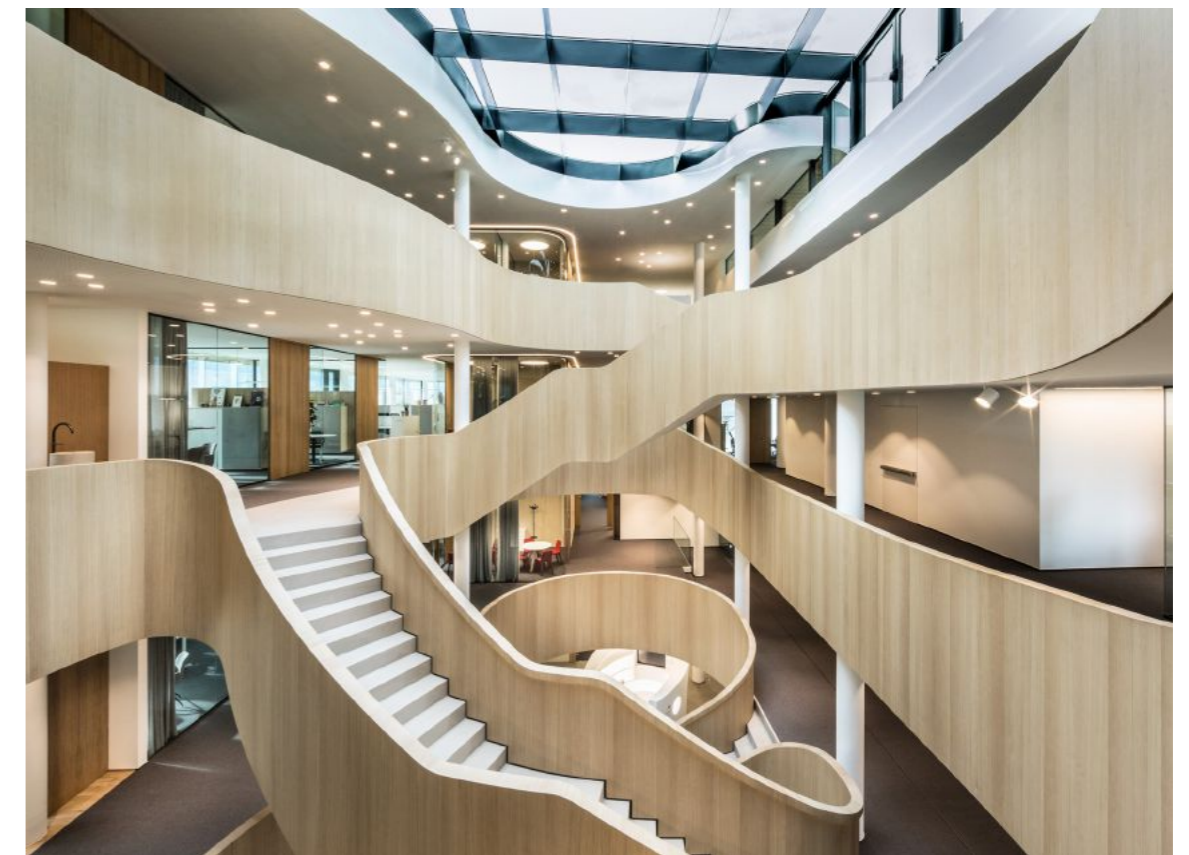
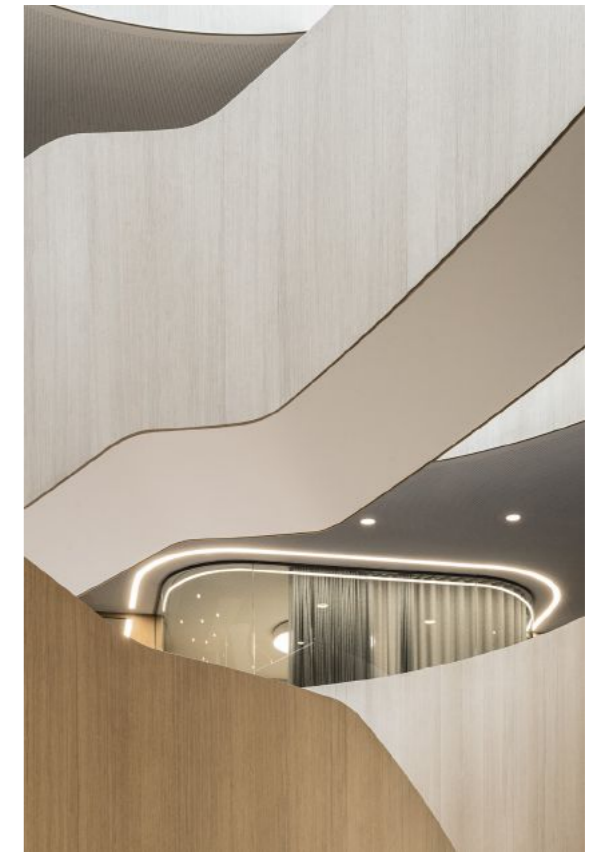

RLB headquarters Graz, AT –
by Strohecker ZT GmbH with lighting
design by Klaus Elektro-Anlagen



← back



FRAME 100 system

recessed with trim

EN Luminaire housing made of extruded aluminium; recessed luminaire with trim; for continuous lighting systems; for ceiling thickness of 8-25 mm; surface powder coated; luminaire profile for mounting available in advance; remaining luminaire components mounted without tools; light inset consisting of highly reflective coated extruded profile for improved thermal management; option: lighting module is versatile in length; HPO (High Performance Opal) cover for uniform illumination; micro prismatic PMMA diffuser incl. diffuser film for homogeneous illumination and reduced luminance; wallwasher light inset; energy-efficient LEDs with very good colour rendering

ES Cuerpo de lámpara de perfil extrusionado de aluminio; luminaria empotrable con marco; diseñado para la creación de sistemas continuos; apropiada para grosores de techo entre 8-25 mm; superficie con recubrimiento de pintura en polvo; Perfil disponible para pre-montaje; resto de componentes luminosos montables sin herramienta; elemento de luz formado por perfil extruido con acabado altamente reflectante para una gestión térmica mejorada; elemento de luz opcional recortable a discreción; difusor opal de alta calidad que proporciona una iluminación uniforme; cubierta microprismática de PMMA con lámina difusora para la reducción de iluminancia y un alumbrado homogéneo; inserto bañador de pared; LEDs de alta eficiencia que proporcionan una alta reproducción cromática

Quickinfo

3000K, 4000K, TW
 CRI ≥ 80, CRI ≥ 90, 3 SDCM
 UGR ≤ 19 / 65° ≤ 3000 cd/m²
 up to 3090 lm/m
 up to 140 lm/W
 L90 @ 50 000h
 non DIM, DALI-2
 opal, microprismatic (UGR ≤ 19)

Types

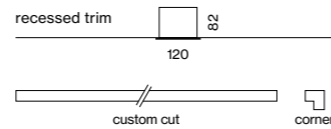

Colours



Light distributions



DiiA® standards
251, 252, 253



single luminaire
(p. 522)



wallwasher
inset (p. 944)

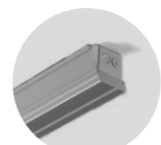

concrete install.
housing (p. 946)



flexible
inset



DIN EN 12464-1
UGR ≤ 19

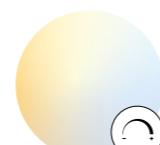

tunable white
2700–6500 K

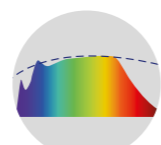

CRI ≥ 98
XPECTRUM

Order options

LED TYPE	
mid lumen	L
high lumen	M

COLOUR TEMPERATURE	
3000 K (CRI ≥ 90)	0
4000 K (CRI ≥ 90)	1
3000 K (CRI ≥ 80)	5
4000 K (CRI ≥ 80)	6
tunable white 2700–6500 K*	

*DALI-2 DT8

CONTROL	
non DIM	1
DALI-2 (only high lumen)	3

MATERIAL COLOUR	
○ traffic white RAL 9016	7
● white aluminium RAL 9006	G

LIGHT OPTIC COVER	
opal high performance	H
microprismatic	Z
microprismatic (UGR ≤ 19)*	G
blind cover**	B

*UGR ≤ 19 only with mid lumen
 **only for channel corner 90°

EMERGENCY LIGHT	
1h Accupack	N L 1
3h Accupack	N L 3

Options on request

COLOUR RENDERING INDEX	
CRI ≥ 98 XPECTRUM	

CONNECTOR	
X- and T-connector	

LUMINOUS FLUX value calculated for CRI ≥ 80, colour white, cover opal microprism. Z -8%, microprism. G -10%

FRAME 100 trim

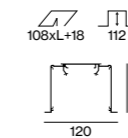

INSTALLATION CHANNEL / CORNER 90°	L (mm)	ORDER CODE
channel	1172	035-0125
channel	1472	035-0155
channel	3000	035-0305
channel	custom	E 82150
channel corner 90° + cover	205x205	035-1265

LIGHT OPTIC COVER / BLIND COVER	L (mm)	ORDER CODE
linear	1171	006-12122
linear	1470	006-12152
linear	2997	006-12302
linear	custom	E 80650
blind cover	3000	006-1130
blind cover	custom	E 80650

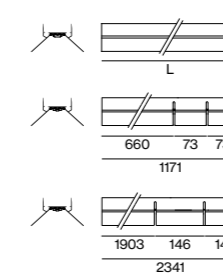
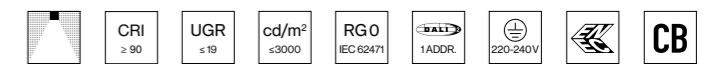

LIGHT INSET 100	SYSTEM POWER (MID/HIGH LUMEN)	L (mm)	ORDER CODE
8.7/13.8 W		571	007-862
13/20.6 W		871	007-863
15.3/27.5 W		1171	007-864
19.2/34 W		1463	007-865
31/55 W		2341	007-868
38/68 W		2997	007-869
15.3/27.5 W flex		660-1171	007-86F
31/55 W flex		1903-2341	007-86G

COVER	COLOUR TEMP.	SYSTEM POWER	DELIVERED LUMENS	EFFICACY
mid lumen/opal	3000 K	14 W/m	1770 lm/m	132 lm/W
high performance	4000 K		1870 lm/m	140 lm/W
high lumen/opal	3000 K	24 W/m	2920 lm/m	123 lm/W
high performance	4000 K		3090 lm/m	130 lm/W

LIGHT INSET 100 tunable white 2700–6500 K	SYSTEM POWER	L (mm)	ORDER CODE
21.7 W		871	007-8633D37
29 W		1171	007-8634D37
36 W		1463	007-8635D37
58 W		2341	007-8638D37

Accessories

END CAPS	ORDER CODE
end caps (pair)	035-1315

LINEAR CONNECTOR / THROUGH WIRE	ORDER CODE
linear connector (1 piece)	005-40066
linear connector (10 pieces)	005-40066.10
opal cover linear connector	006-10000
through wire 3 × 1.5 mm² (non DIM, 10 pieces)	004-90003
through wire 5 × 1.5 mm² (DALI-2, 10 pieces)	004-90005

MOUNTING BRACKET	CEILING THICKNESS (mm)	ORDER CODE
mounting bracket (1 piece)	8-25	035-10230
mounting bracket (25 pieces)	8-25	035-10230.25

number of brackets required: length of your system in metres+1



CMS Office Paris, FR –
by Lobjoy & Bouvier & Boisseau



Discreet profile system

CANYON system

EN The CANYON system luminaire radiates calm and makes visitors feel welcome – whether in entrance halls, at the reception, or in corridors or lounges. The specially developed, flex insets, which can be shortened, make the luminaire a true all-round talent; with its tailored profile length, the luminaire can also be transformed into a customised lighting system by using CORNER elements. Also noteworthy: When combined with the opal cover, the CANYON system luminaire creates uniform ambient lighting. For workstations, it can be perfectly adapted to office conditions using insets with microprismatic covers.

ES La luminaria modular CANYON irradia tranquilidad y hace que los visitantes –ya sea en vestíbulos, en la recepción, en pasillos o en salas de descanso– se sientan bienvenidos. Los insertos Flex acortables de creación especial convierten a esta luminaria en una verdadera multitallento: con la longitud de perfil deseada, la luminaria puede transformarse asimismo en un sistema de iluminación individual utilizando elementos CORNER. Otro aspecto destacable es que, en combinación con el difusor opal, la luminaria modular CANYON proporciona un alumbrado general uniforme. En puestos de trabajo, la luminaria puede adaptarse perfectamente a cualquier entorno de oficina con insertos dotados de difusor microprismático.

Type



60

Mounting

trim
recessed

Configurations



linear



corner

Light distributions

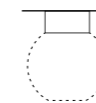

opal

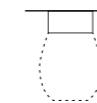
microprismatic
(UGR ≤ 19)

← back



CANYON 60 system

recessed offset with trim

EN Luminaire housing made of extruded aluminium; uncluttered ceiling look through recessed lighting level; recessed luminaire with trim; for continuous lighting systems; for ceiling thickness of 8-25mm; surface powder coated; luminaire profile for mounting available in advance; remaining luminaire components mounted without tools; light inset consisting of highly reflective coated extruded profile for improved thermal management; option: lighting module is versatile in length; HPO (High Performance Opal) cover for uniform illumination; micro prismatic PMMA diffuser incl. diffuser film for homogeneous illumination and reduced luminance; wallwasher light inset; energy-efficient LEDs with very good colour rendering

ES Cuerpo de lámpara de perfil extrusionado de aluminio; vista de techo con luminaria empotrada; luminaria empotrable con marco; para sistemas de iluminación continuos; para espesores de techo de 8-25mm; superficie con recubrimiento de pintura en polvo; Perfil disponible para pre-montaje; resto de componentes luminosos montables sin herramienta; elemento de luz formado por perfil extruido con acabado altamente reflectante para una gestión térmica mejorada; elemento de luz opcional recortable a discreción; difusor opal de alta calidad que proporciona una iluminación uniforme; cubierta microprismática de PMMA con lámina difusora para la reducción de iluminancia y un alumbrado homogéneo; inserto bañador de pared; LEDs de alta eficiencia que proporcionan una alta reproducción cromática

Quickinfo

3000K, 4000K, TW
 CRI ≥ 80, CRI ≥ 90, 3 SDCM
 up to 2280lm/m
 up to 105lm/W
 L90 @ 50 000h
 non DIM, DALI-2
 opal, microprismatic

Types

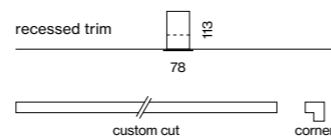

Colours



Light distributions



Order options

LED TYPE	
mid lumen	L
high lumen	M

COLOUR TEMPERATURE	
3000K (CRI ≥ 90)	0
4000K (CRI ≥ 90)	1
3000K (CRI ≥ 80)	5
4000K (CRI ≥ 80)	6
tunable white 2700–6500K*	

*DALI-2 DT8

CONTROL	
non DIM	1
DALI-2 (only high lumen)	3

MATERIAL COLOUR	
○ traffic white RAL 9016	7
● jet black RAL 9005	8

LIGHT OPTIC COVER	
opal high performance	H
microprismatic	Z
blind cover*	B

*only for channel corner 90°

EMERGENCY LIGHT	
1h Accupack	N L 1
3h Accupack	N L 3

Options on request

COLOUR RENDERING INDEX	
CRI ≥ 98 XPECTRUM	

CONNECTOR	
X- and T-connector	

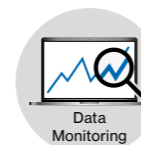

DiiA® standards
251, 252, 253



single luminaire
(p.528)



wallwasher
inset (p.944)



ball-impact-
resistant



glare control
UGR ≤ 19

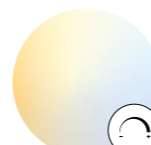

tunable white
2700–6500K

LUMINOUS FLUX value calculated for CRI ≥ 80, colour white, cover opal microprismatic -13%

CANYON 60 trim offset

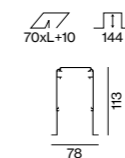

INSTALLATION CHANNEL / CORNER 90°	L (mm)	ORDER CODE
channel	1172	038-5127
channel	1472	038-5157
channel	3000	038-5307
channel	custom	E82330
channel corner 90° + cover	144x144	038-6267

LIGHT OPTIC COVER / BLIND COVER

TYPE	L (mm)	ORDER CODE
linear	1171	006-16122
linear	1470	006-16152
linear	2997	006-16302
linear	custom	E80630
blind cover	1472	006-1815
blind cover	custom	E80630



LIGHT INSET 60

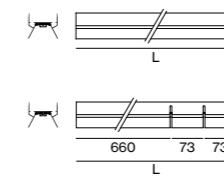

SYSTEM POWER (MID / HIGH LUMEN)	L (mm)	ORDER CODE
8.7 / 13.8 W	571	007-932
13 / 20.6 W	871	007-933
15.3 / 27.5 W	1171	007-934
19.2 / 34 W	1463	007-935
31 / 55 W	2341	007-938
38 / 68 W	2997	007-939
15.3 / 27.5 W flex	660-1171	007-93F
31 / 55 W flex	1903-2341	007-93G

COVER	COLOUR TEMP.	SYSTEM POWER	DELIVERED LUMENS	EFFICACY
mid lumen / opal	3000K	14 W/m	1300lm/m	99lm/W
high performance	4000K		1380lm/m	105lm/W
high lumen / opal	3000K	24 W/m	2160lm/m	92lm/W
high performance	4000K		2280lm/m	98lm/W

LIGHT INSET 60 tunable white 2700–6500K

SYSTEM POWER	L (mm)	ORDER CODE
21.7 W	871	007-9333D37
29 W	1171	007-9334D37
36 W	1463	007-9335D37
58 W	2341	007-9338D37

Accessories

END CAPS

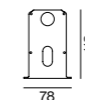

TYPE	ORDER CODE
end caps (pair)	038-6307

LINEAR CONNECTOR / THROUGH WIRE

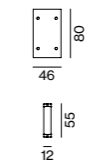

TYPE	ORDER CODE
linear connector (1 piece)	005-40046
linear connector (10 pieces)	005-40046.10
opal cover linear connector	006-14000
through wire 3 × 1.5 mm ² (non DIM, 10 pieces)	004-90003
through wire 5 × 1.5 mm ² (DALI-2, 10 pieces)	004-90005

MOUNTING BRACKET



TYPE	CEILING THICKNESS (mm)	ORDER CODE
mounting bracket (1 piece)	8-25	038-60700
mounting bracket (25 pieces)	8-25	038-60700.25

number of brackets required: length of your system in metres+1



Microsoft headquarters
Vienna, AT – by INNOCAD Architektur ZT



Define your profile system

MINO system

EN The MINO system luminaire complements the multifaceted nature of the MINO single luminaire. Whether as a surface-mounted version for wall or ceiling mounting, or as a suspended version with an indirect light component, the MINO System luminaire is truly versatile. Using CURVE elements, which come in various radii, and CORNER elements, the luminaires are transformed into a continuous lighting system. With three standard and additional special colours available, MINO can be customised according to the desired room concept. You can also combine the light insets for homogeneous ambient lighting with an opal cover. Other options include the use of a wallwasher for a uniformly illuminated wall surface, or the microprismatic cover specially designed for workstations. Excellent colour rendering and three possible light colours complete the MINO system luminaire.

ES La luminaria modular MINO completa la gran versatilidad de la luminaria individual MINO. Ya sea como variante de superficie para el montaje en pared o techo o en el modelo de suspensión con proporción de luz indirecta, la luminaria modular MINO admite un uso muy variado. Mediante elementos CORNER y los elementos CURVE disponibles en radios diversos, las distintas luminarias se transforman en un sistema de iluminación continuo. Los tres colores estándar y otros colores especiales disponibles hacen que MINO pueda adaptarse al diseño interior específico. Si lo desea, puede combinar (incluso parcialmente) los insertos luminosos con un difusor opal para obtener un alumbrado general homogéneo o con un bañador de luz para la iluminación uniforme de paredes, o utilizar un difusor microprismático concebido especialmente para la iluminación de puestos de trabajo. La luminaria modular MINO se completa con una muy buena reproducción cromática y tres temperaturas de color disponibles.

Types

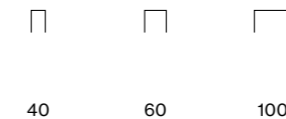

40 60 100

Mountings

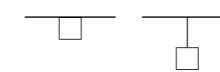

surface suspended

Configurations

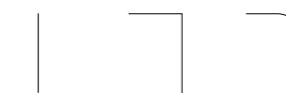

linear corner curve

Light distributions

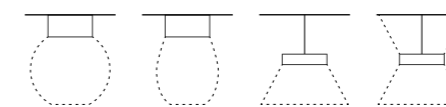

opal microprismatic
(UGR ≤ 19) direct direct
indirect

TW – Tunable White

EN Changes in the colour of light have a substantial effect on our mood. Tunable White allows the colour temperature to be continuously adjusted from 2700 K (warm light) to 6500 K (cool light) to dynamically adapt the lighting to the time of day or ambient brightness.

ES Los cambios de color de la luz tienen un efecto considerable en nuestro estado de ánimo. Tunable White hace posible una modificación continua de la temperatura de color desde 2700 K (luz cálida) hasta 6500 K (luz fría), con el fin de adaptar la iluminación de forma dinámica a la hora del día o a la luminosidad del entorno.

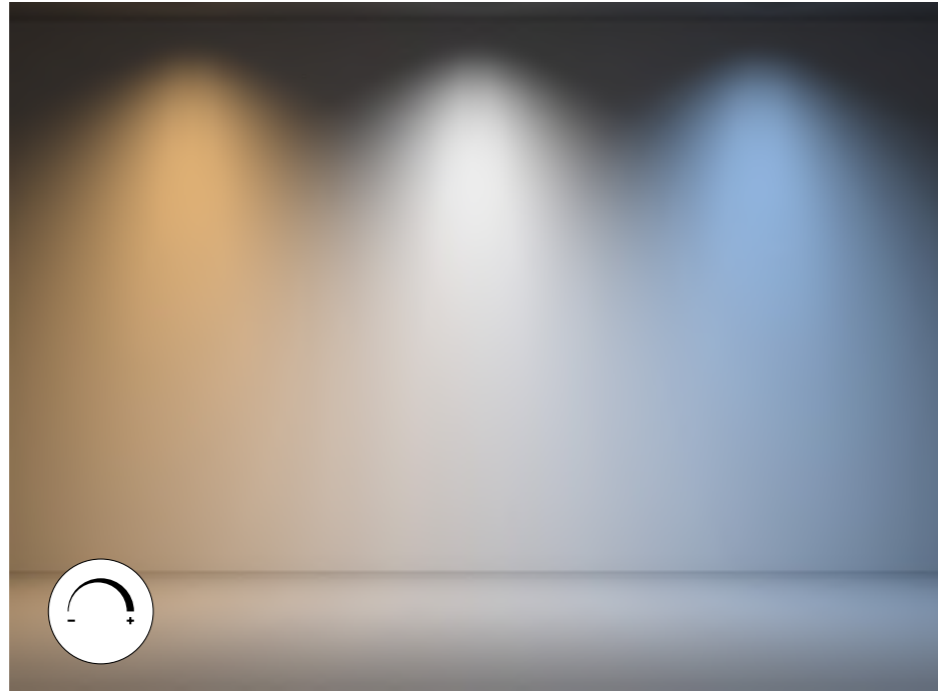

Precise planning with flex insets

EN Your lighting system can be easily adapted to existing room dimensions. You can determine bespoke lengths for MINO. The special flex insets are precisely and flexibly adapted on-site during assembly. Boards are simply cut off at prefabricated breakpoints. This gives you a free hand and minimal restrictions in the lighting design.

ES Su sistema de iluminación puede adaptarse fácilmente a las dimensiones espaciales requeridas. Para los perfiles Advanced, puede elegir las longitudes que prefiera. Las inserciones especiales Flex se adaptan durante el montaje con exactitud y flexibilidad: las pletinas se separan fácilmente por áreas de rotura prefabricadas. Esto le ofrece una total libertad y evita numerosas restricciones en la planificación de la iluminación.

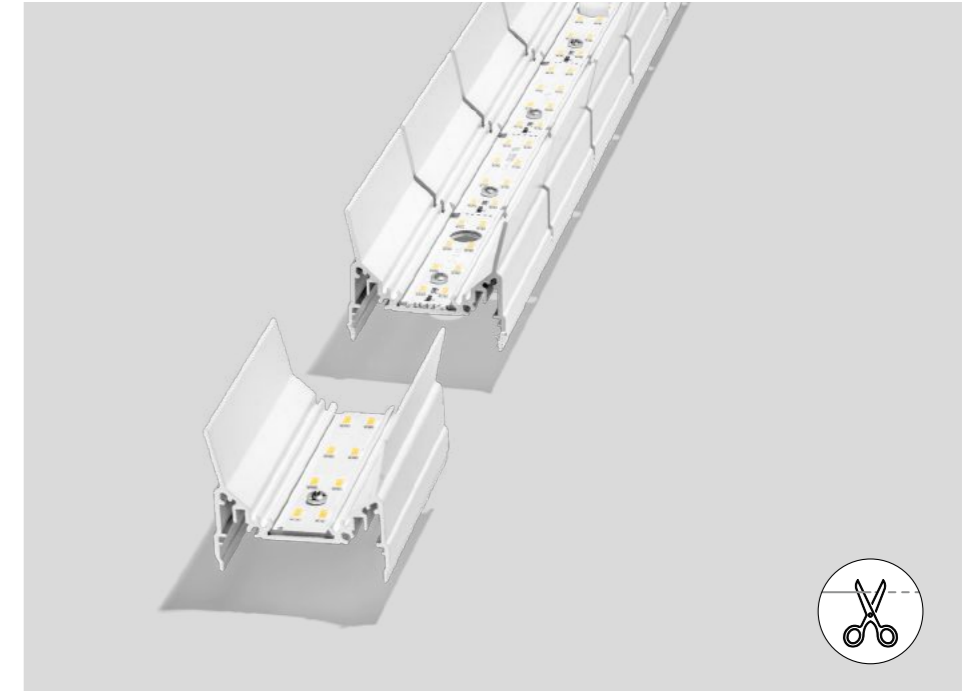

Full-spectrum LED

EN XAL's new XPECTRUM LEDs deliver healthy, biologically effective light. The reduced blue light component and increased cyan values reduce the blue light hazard for the eye to daylight-equivalent levels. The resulting non-visual, so-called melanopic light effect, improves concentration and increases sleep quality. The excellent colour rendering of IES TM 30-15 $R_f = 98$ and $R_g = 101$ further helps visual comfort.

ES El nuevo LED XPECTRUM de XAL ofrece una luz saludable con efectos biológicos. La menor proporción de luz azul y el aumento de los valores de cian minimizan el riesgo de la incidencia de luz azul en el ojo, manteniéndola a un nivel similar al presente en la luz natural. El efecto no visible resultante, denominado efecto melanópico, fomenta la concentración y mejora la calidad del sueño. Además, su excelente reproducción cromática –con índices $R_f = 98$ y $R_g = 101$ según la norma IES TM-30-15– garantiza una mayor comodidad visual.

XPECTRUM LED

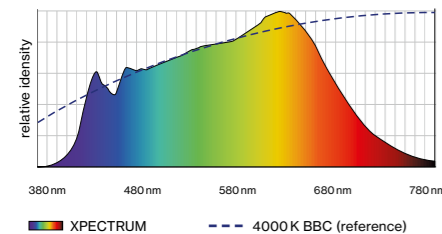

Commercially available LED 4000 K

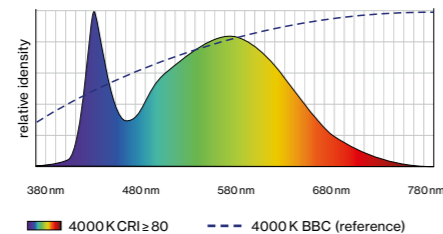

Colour variety

EN MINO is available in the standard colours black, grey, and white. Further colour variations are also available, granting your project maximum design freedom. You can learn more about our colour palette at xal.com/colours.

ES Todos los perfiles Advanced están disponibles en diversos colores estándar. Además existen otras gamas de color disponibles, lo que le proporciona la máxima libertad de diseño para su proyecto. Encontrará más información sobre nuestra paleta de colores en xal.com/colours.



xal.com/colours

Curves & edges

EN Let your creativity run wild and combine straight profiles with precise corners or harmonious curves. The curve profiles are available in different radii to generate maximum design freedom.

ES Dé rienda suelta a su creatividad conectando perfiles rectilíneos a esquinas precisas o curvas armoniosas. Los perfiles curvos están disponibles en distintos radios para ofrecer la máxima libertad de diseño. Ya que todos los elementos de perfil encajan entre sí, podrá diseñar sistemas de configuración personalizada adaptados a sus deseos y al espacio disponible.



← back

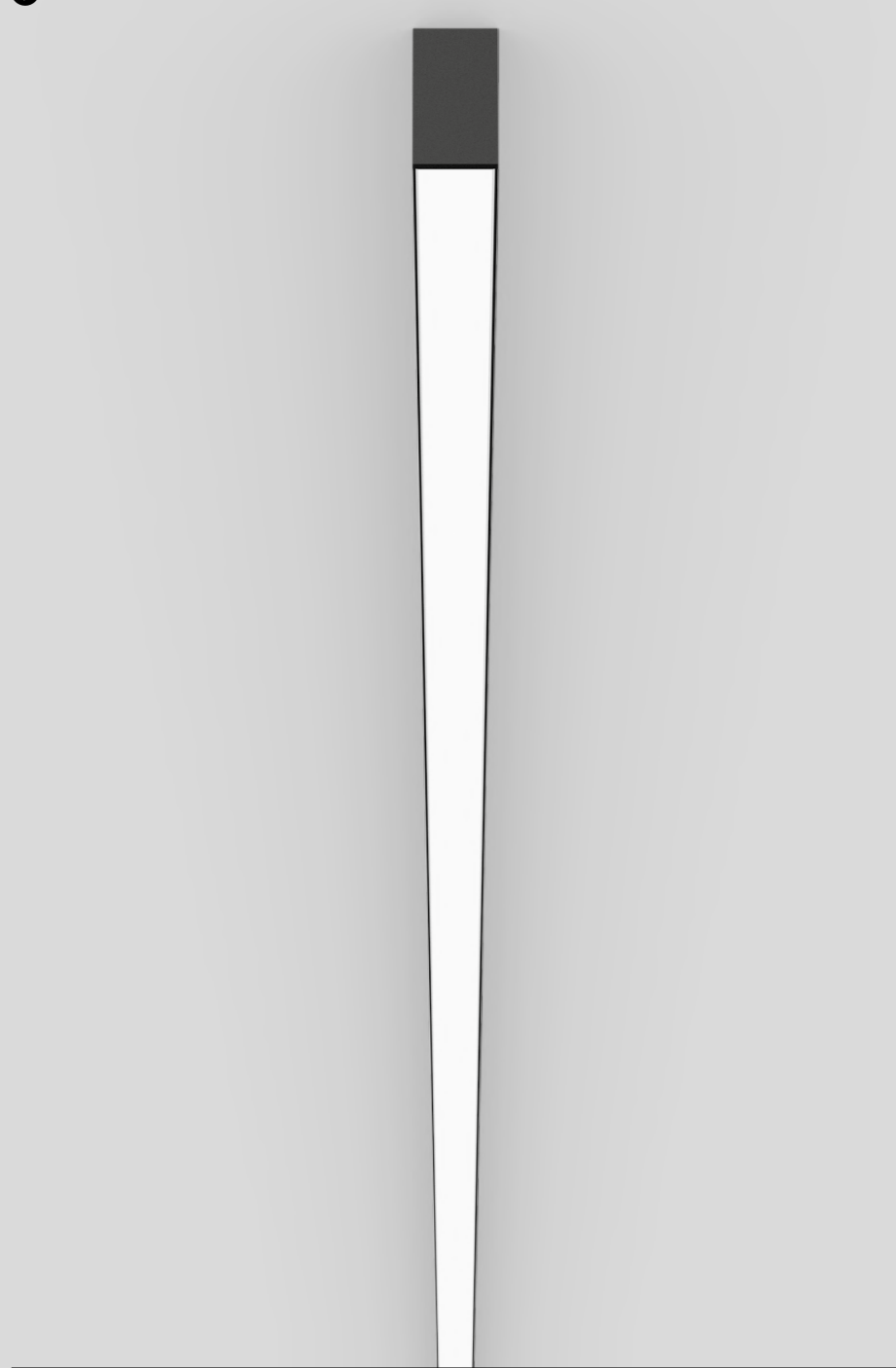

MINO 40 system

ceiling/suspended

EN Luminaire housing from extruded aluminium profile, angular design; no visible screws; for lighting systems; powder coated; luminaire profile incl. light inset; cover in the length of the light inset or continuous cover (both separately available); pre-assembled power rail for power supply in luminaire profile; voltage tap of the light inset on the power rail; pendant fitting with cable suspension; height adjustment without tools; with transparent feeder cable; light inset consisting of highly reflective coated extruded profile for improved thermal management; HPO (High Performance Opal) cover for uniform illumination; energy-eff. LEDs – very good colour rendering

ES Cuerpo de perfil de aluminio con diseño angular; sin tornillos visibles; para sistemas de iluminación; recubierto de polvo; perfil de lumin. con inserto lumin.; difusor en longitud de inserto luminoso o continuo (ambos deben encargarse por separado); carril eléctrico premont. para suministro de corr. en perfil de lumin.; toma de corr. para inserto lumin. en carril eléctrico; suspendido con cable; altura regulable sin herramientas; incl. cable de alimentación transparente; elemento de luz formado por perfil extruido con acabado altamente reflectante para una gestión térmica mejorada; difusor opal de alta calidad que proporciona una iluminación uniforme; LED energét. efíc. – excelente reprod. crom.

Quickinfo

3000K, 4000K
 CRI ≥ 90, 3 SDCM
 up to 2340lm/m
 up to 102lm/W
 L90 @ 50 000h
 DALI-2
 opal

Types

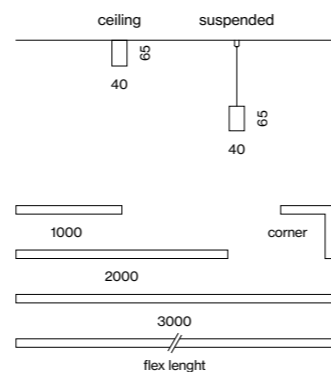

Colours



Light distribution

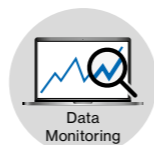

DiiA® standards
 251, 252, 253



single luminaire
 (p.536)

flexible
 inset

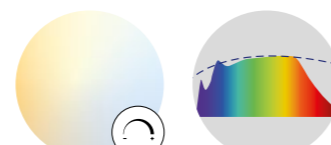

tunable white
 2700–6500K

CRI ≥ 98
 XPECTRUM

Order options

LED TYPE	
mid lumen	1
high lumen	2

COLOUR TEMPERATURE	
3000K	0
4000K	1

CONTROL
 DALI-2

MATERIAL COLOUR	
○ pure white RAL 9010	7
● white aluminium RAL 9006	G
● jet black RAL 9005	8
● special colours p.992	X

MATERIAL COLOUR	
○ pure white RAL 9010	7
● jet black RAL 9005	8

LIGHT OPTIC COVER
 opal high performance

Options on request

COLOUR RENDERING INDEX
 CRI ≥ 98 XPECTRUM

COLOUR TEMPERATURE
 tunable white 2700–6500K

LIGHT OPTIC COVER
 microprismatic

LUMINOUS FLUX value calculated for
 CRI ≥ 90, colour white, cover opal

MINO 40 ceiling/suspended



INSTALLATION CHANNEL + LIGHT INSET

SYSTEM POWER (MID/HIGH LUMEN)	L (mm)	ORDER CODE
15.3/22.9W	1000	0 4 2 - 1 0 A 2 3 3
30.5/46W	2000	0 4 2 - 1 0 A 4 3 3
46/69W	3000	0 4 2 - 1 0 A 6 3 3
15.3/22.9W flex	500–1000	0 4 2 - 1 0 A F 3 3
30.5/46W flex	1500–2000	0 4 2 - 1 0 A G 3 3
15.3/22.9W corner	500×500	0 4 2 - 1 0 A C 3 3

COVER	COLOUR TEMP.	SYSTEM POWER	DELIVERED LUMENS	EFFICACY
mid lumen/opal	3000K	15.3 W/m	1480lm/m	97lm/W
high performance	4000K		1560lm/m	102lm/W
high lumen/opal	3000K	22.9 W/m	2210lm/m	97lm/W
high performance	4000K		2340lm/m	102lm/W

LIGHT OPTIC COVER 40

TYPE	L (mm)	ORDER CODE
linear	1000	0 0 6 - 4 2 1 0 0 1 0 H
linear	2000	0 0 6 - 4 2 2 0 0 1 0 H
linear	3000	0 0 6 - 4 2 3 0 0 1 0 H
corner	500×500	0 0 6 - 4 2 0 5 0 2 0 H
continuous linear	6000	0 0 6 - 2 2 0 6 0 1 0 H
continuous linear	30000	0 0 6 - 2 2 3 0 0 1 0 H

Accessories

END CAPS

TYPE	ORDER CODE
end caps (pair)	0 4 2 - 1 0 9 0 0 1

CHANNEL + BLIND COVER

TYPE	L (mm)	ORDER CODE
linear	1000	0 4 2 - 1 0 9 4 2 1
linear	2000	0 4 2 - 1 0 9 4 4 1
linear	3000	0 4 2 - 1 0 9 4 6 1
corner	500×500	0 4 2 - 1 0 9 4 C 1

POWER FEEDER UNIT

TYPE	ORDER CODE
power feeder unit	0 4 2 - 1 0 9 3 2 3 0

LINEAR CONNECTOR

TYPE	ORDER CODE
mechanical linear connector	0 4 2 - 1 0 9 1 1 1 0
mechanical + electrical linear connector	0 4 2 - 1 0 9 1 2 3 0
opal cover linear connector	0 4 2 - 1 0 9 1 9 1 0

CEILING FASTENER/CABLE SUSPENSION/CANOPY

TYPE	L (mm)	ORDER CODE
ceiling fastener	10	0 5 0 - 2 0 4 1 1 1
cable suspension	1500	0 0 5 - 2 1 5 2 1 1 0
canopy		0 0 5 - 2 3 1 1 2 1
feeder cable (transparent)		0 0 5 - 2 4 1 2 4 1 0

for electrical system configuration see luminaire data sheet at xal.com

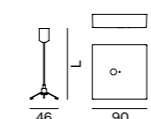

← back

MINO 60 system

ceiling / suspended

EN Luminaire housing from extruded aluminium profile, angular design; no visible screws; for lighting systems; powder coated; luminaire profile for mounting available in advance; remaining components mounted without tools; pendant fitting with cable suspension; height adjustment without tools; spring clip attachment to the luminaire; with transparent feeder cable; light inset consisting of highly reflective coated extruded profile for improved thermal management; option: lighting module is versatile in length; HPO (High Performance Opal) cover for uniform illumination; micro prismatic PMMA diffuser incl. diffuser film for homogeneous illumination and reduced luminance; wallwasher light inset; energy-eff. LEDs – very good colour rendering

ES Cuerpo de perfil de aluminio con diseño angular; sin tornillos visibles; para sistemas de iluminación; recubierto de polvo; Perfil disponible para pre-montaje; los demás componentes se pueden montar sin herramientas; suspendido con cable; altura regulable sin herramientas; fijación en la lámpara por medio de clips elásticos; incl. cable de alimentación transparente; elemento de luz formado por perfil extruido con acabado altamente reflectante para una gestión térmica mejorada; elemento de luz opcional recortable a discreción; difusor opal de alta calidad que proporciona una iluminación uniforme; cubierta microprismática de PMMA con lámina difusora para la reducción de iluminancia y un alumbrado homogéneo; inserto bañador de pared; LED energét. efíc. – excelente repro. crom.

Quickinfo

3000K, 4000K, TW
 CRI ≥ 80, CRI ≥ 90, 3 SDCM
 up to 2760 lm/m
 up to 125 lm/W
 L90 @ 50 000h
 non DIM, DALI-2
 opal, microprismatic (UGR ≤ 19)

Types

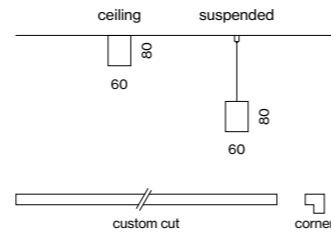

Colours



Light distributions



DiiA® standards
251, 252, 253



single luminaire
(p. 544)



wallwasher
inset (p. 944)

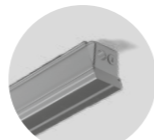

concrete install.
housing (p. 946)



flexible
inset

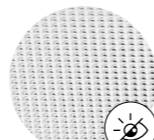

microprismatic
UGR ≤ 19

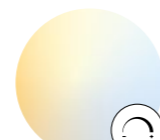

tunable white
2700–6500 K

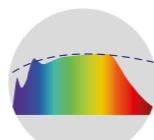

CRI ≥ 98
XPECTRUM

Order options

LED TYPE	
mid lumen	L
high lumen	M

COLOUR TEMPERATURE	
3000 K (CRI ≥ 90)	0
4000 K (CRI ≥ 90)	1
3000 K (CRI ≥ 80)	5
4000 K (CRI ≥ 80)	6
tunable white 2700–6500 K*	

*DALI-2 DT8

CONTROL	
non DIM	1
DALI-2 (only high lumen)	3

MATERIAL COLOUR	
○ pure white RAL 9010	7
● white aluminium RAL 9006	G
● jet black RAL 9005	8
● special colours p. 992	X

LIGHT OPTIC COVER	
opal high performance	H
microprismatic	Z
microprismatic (UGR ≤ 19)*	G
blind cover only for corner 90°	B

*UGR ≤ 19 only with mid lumen

EMERGENCY LIGHT	
1h Accupack	1
3h Accupack	3

Options on request

COLOUR RENDERING INDEX	
CRI ≥ 98 XPECTRUM	

CONNECTORS	
X- and T-connector	

LUMINOUS FLUX value calculated for CRI ≥ 80, colour white, cover opal microprismatic -13%

MINO 60 ceiling / suspended



INSTALLATION CHANNEL / CORNER 90°			ORDER CODE
TYPE	L (mm)		
channel	1172		046-400401
channel	1472		046-400501
channel	3000		046-400901
channel	custom		E85031
channel corner 90° + cover	150x150		046-401121

LIGHT OPTIC COVER / BLIND COVER			ORDER CODE
TYPE	L (mm)		
linear	1171		006-16122
linear	1470		006-16152
linear	2997		006-16302
linear	custom		E80630
continuous linear	6000		006-23061H
continuous linear	25000		006-23251H
blind cover	3000		006-1830
blind cover	custom		E80630

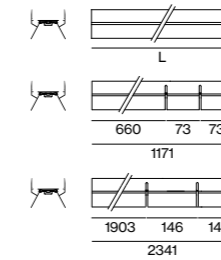

LIGHT INSET 60			ORDER CODE
SYSTEM POWER (MID / HIGH LUMEN)	L (mm)		
8.7 / 13.8 W	571		007-932
13 / 20.6 W	871		007-933
15.3 / 27.5 W	1171		007-934
19.2 / 34 W	1463		007-935
31 / 55 W	2341		007-938
38 / 68 W	2997		007-939
15.3 / 27.5 W flex	660-1171		007-93F
31 / 55 W flex	1903-2341		007-93G

COVER	COLOUR TEMP.	SYSTEM POWER	DELIVERED LUMENS	EFFICACY
mid lumen / opal	3000 K	14 W/m	1540 lm/m	118 lm/W
high performance	4000 K		1640 lm/m	125 lm/W
high lumen / opal	3000 K	24 W/m	2540 lm/m	110 lm/W
high performance	4000 K		2700 lm/m	116 lm/W

LIGHT INSET 60 tunable white 2700–6500 K			ORDER CODE
SYSTEM POWER	L (mm)		
21.7 W	871		007-9333D37
29 W	1171		007-9334D37
36 W	1463		007-9335D37
58 W	2341		007-9338D37

Accessories



END CAPS		ORDER CODE
TYPE		
end caps (pair)		046-501001

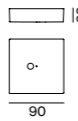

LINEAR CONNECTOR / THROUGH WIRE		ORDER CODE
TYPE		
linear connector (1 piece)		005-40046
linear connector (10 pieces)		005-40046.10
opal cover linear connector		006-14000
through wire 3 × 1.5 mm ² (non DIM, 10 pieces)		004-90003
through wire 5 × 1.5 mm ² (DALI-2, 10 pieces)		004-90005

CEILING CLIP / CABLE SUSPENSION / CANOPY		ORDER CODE
TYPE	L (mm)	
ceiling clip	10	034-11636
cable suspension	1500	005-2122110
canopy / feeder cable 3 × 1.5 mm ²	1500	005-221231
canopy / feeder cable 5 × 1.5 mm ²	1500	005-221241
cable rail	1200	005-2491110

for electrical system configuration see luminaire data sheet at xal.com

← back

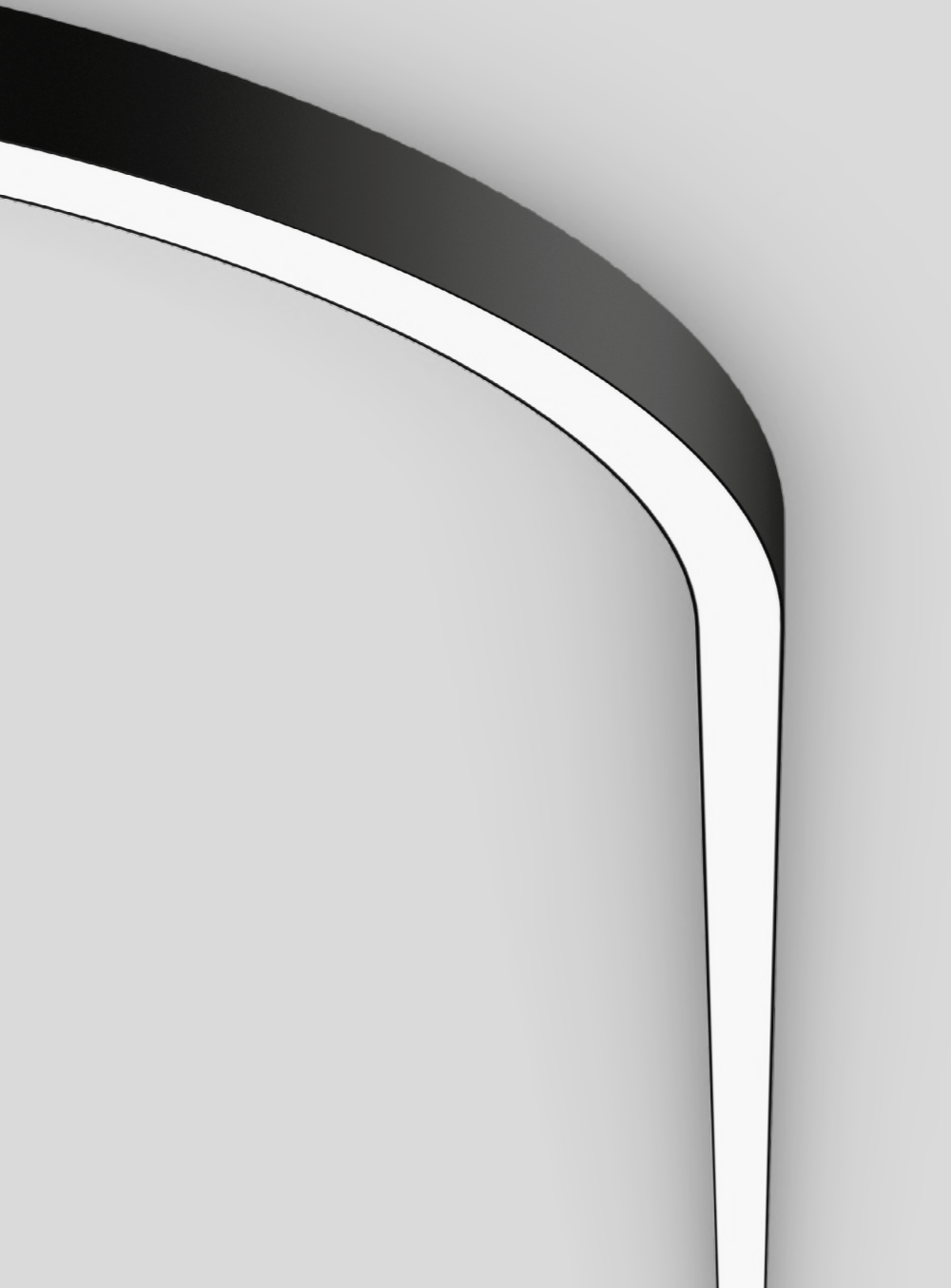

MINO 60 CURVE system

ceiling / suspended

EN Circular segment of rolled aluminium profile, angular design, seamlessly welded; no visible screws; for lighting systems; powder coated; luminaire profile for mounting available in advance; remaining components mounted without tools; pendant fitting with cable suspension; height adjustment without tools; spring clip attachment to the luminaire; freely positionable; with transparent feeder cable; light inset consisting of highly reflective coated die-cast aluminium for improved thermal management; HPO (High Performance Opal) cover for uniform illumination; micro prismatic PMMA diffuser incl. diffuser film for homogeneous illumination and reduced luminance; energy-eff. LEDs – very good colour rendering

ES Segmento circular de perfil de aluminio enrollado, versión angulosa, soldado sin costuras; sin tornillos visibles; para sistemas de iluminación; recubierto de polvo; Perfil disponible para pre-montaje; los demás componentes se pueden montar sin herramientas; suspendido con cable; altura regulable sin herramientas; fijación en la lámpara por medio de clips elásticos; ajustable de una manera sencilla; incl. cable de alimentación transparente; elemento de luz formado por fundación de aluminio con acabado altamente reflectante para una gestión térmica mejorada; difusor opal de alta calidad que proporciona una iluminación uniforme; cubierta microprismática de PMMA con lámina difusora para la reducción de iluminación y un alumbrado homogéneo; LED energét. efíc. – excelente reprod. crom.

Quickinfo

3000K, 4000K
 CRI ≥ 80, 3 SDCM
 up to 2850 lm/m
 up to 125 lm/W
 L90 @ 50 000h
 non DIM, DALI-2
 opal, microprismatic

Types

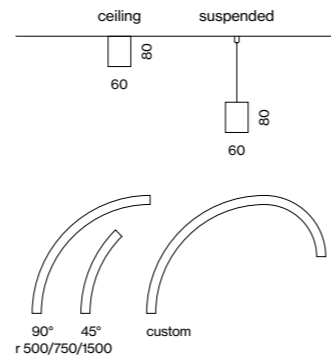

Colours



Light distributions



Order options

LED TYPE	
mid lumen	4
high lumen	5

COLOUR TEMPERATURE	
3000K	5
4000K	6

CONTROL	
non DIM	1
DALI-2 (only high lumen)	3

MATERIAL COLOUR	
○ pure white RAL 9010	7
● white aluminium RAL 9006	G
● jet black RAL 9005	8
● special colours p. 992	X

LIGHT OPTIC COVER	
opal high performance	H
microprismatic	Z

Options on request

COLOUR RENDERING INDEX
CRI ≥ 90
CRI ≥ 98 XPECTRUM

LIGHT OPTIC COVER
microprismatic (UGR ≤ 19)

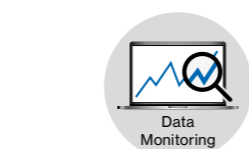

DiiA® standards
 251, 252, 253

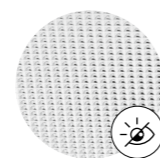

microprismatic
 UGR ≤ 19

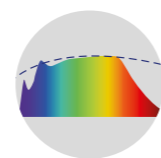

CRI ≥ 98
 XPECTRUM

LUMINOUS FLUX value calculated for
 CRI ≥ 80, colour white, cover opal
 microprismatic -13%

MINO 60 CURVE ceiling/suspended



INSTALLATION CHANNEL + LIGHT INSET + LIGHT OPTIC COVER

SYSTEM POWER (MID/HIGH LUMEN)	R (mm)	ORDER CODE
12.8 / 16.3 W	500-90°	034-09 5 5 ::
10.2 / 12.8 W	750-45°	034-09 0 0 ::
18.1 / 26.1 W	750-90°	034-09 1 1 ::
18.1 / 26.1 W	1500-45°	034-09 2 2 ::
36 / 52 W (2×DALI)	1500-90°	034-09 3 3 ::
36 / 52 W (2×DALI)	3000-45°	034-09 4 4 ::

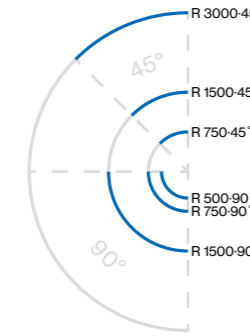

COVER	COLOUR TEMP.	SYSTEM POWER	DELIVERED LUMENS	EFFICACY
mid lumen / opal	3000 K	16 W/m	1780 lm/m	116 lm/W
high performance	4000 K		1880 lm/m	122 lm/W
high lumen / opal	3000 K	22 W/m	2420 lm/m	110 lm/W
high performance	4000 K		2560 lm/m	116 lm/W

Accessories

END CAPS

TYPE	ORDER CODE
end caps (pair)	034-090201

LINEAR CONNECTOR

TYPE	ORDER CODE
linear to curve profile	005-40159
curve to curve profile	005-40158
opal cover linear connector	006-14000

CEILING CLIP / CABLE SUSPENSION / CANOPY

TYPE	L (mm)	ORDER CODE
ceiling clip	10	034-11636
cable suspension	1500	005-2122110
canopy / feeder cable 3 × 1.5 mm ²	1500	005-221231
canopy / feeder cable 5 × 1.5 mm ²	1500	005-221241
cable rail	1200	005-2491110

for electrical system configuration see luminaire data sheet at xal.com

THROUGH WIRE

TYPE	ORDER CODE
3 × 1.5 mm ² (non DIM, 10 pieces)	004-90003
5 × 1.5 mm ² (DALI-2, 10 pieces)	004-90005

← back



MINO 60 direct/indirect system

ceiling / suspended

EN Luminaire housing from extruded aluminium profile, angular design; direct/indirect light distribution; no visible screws; designed for continuous lighting systems; surface powder coated; pendant fitting with cable suspension; with integrated tool-less suspension height adjustment; spring clip attachment to the luminaire; freely positionable; incl. transparent feed; light inset consisting of highly reflective coated extruded profile for improved thermal management; HPO (High Performance Opal) cover for uniform illumination; micro prismatic PMMA diffuser incl. diffuser film for homogeneous illumination and reduced luminance; energy-efficient LEDs with very good colour rendering

ES Cuerpo de perfil de aluminio con diseño angular; característica de emisión directa/indirecta; sin tornillos visibles; diseñado para la creación de sistemas continuos; superficie con recubrimiento de pintura en polvo; suspendido con cable; regulación de la altura sin necesitar herramientas; fijación en las lámparas por medio de enganches elásticos; ajustable de una manera sencilla; incluido cable de alimentación transparente; elemento de luz formado por perfil extruido con acabado altamente reflectante para una gestión térmica mejorada; difusor opal de alta calidad que proporciona una iluminación uniforme; cubierta microprismática de PMMA con lámina difusora para la reducción de iluminancia y un alumbrado homogéneo; LEDs de alta eficiencia que proporcionan una alta reproducción cromática

Quickinfo

3000K, 4000K
 CRI ≥ 80, 3 SDCM
 up to ↓ 2470 / ↑ 1610 lm/m
 up to 120 lm/W
 L90 @ 50 000h
 non DIM, DALI-2
 opal, microprismatic (UGR ≤ 19)

Types

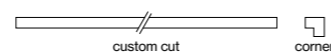
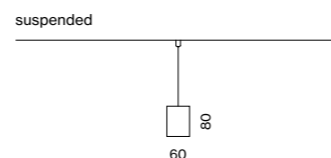

Colours



Light distributions



Order options

LED TYPE
 mid lumen 1
 high lumen 2

COLOUR TEMPERATURE
 3000K 5
 4000K 6

CONTROL
 non DIM 1
 DALI-2 (only high lumen) 3

MATERIAL COLOUR
 ○ pure white RAL 9010 7
 ● white aluminium RAL 9006 G
 ● jet black RAL 9005 8
 ● special colours p. 992 X

LIGHT OPTIC COVER
 opal high performance H
 microprismatic (UGR ≤ 19) Z

Options on request

COLOUR RENDERING INDEX
 CRI ≥ 90
 CRI ≥ 98 XPECTRUM

CHANNEL LENGTH
 3000mm

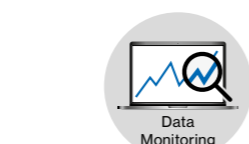

DiiA® standards
 251, 252, 253

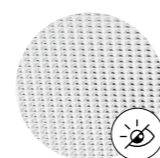

microprismatic
 UGR ≤ 19

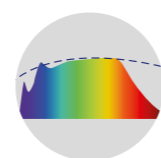

CRI ≥ 98
 XPECTRUM

Light distributions

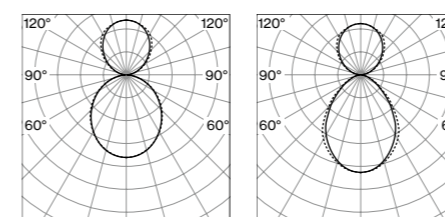

opal
 direct/indirect

microprismatic
 direct/indirect

LUMINOUS FLUX value calculated for
 CRI ≥ 80, colour white, cover opal
 microprismatic -13%

MINO 60 direct/indirect suspended



INSTALLATION CHANNEL + LIGHT INSET + LIGHT OPTIC COVER

SYSTEM POWER (MID/HIGH LUMEN)	L (mm)	ORDER CODE
20.1W/31W	872	046-503
26.8W/41W	1172	046-504
34W/51W	1464	046-505
40W/62W	1756	046-506
54W/82W	2344	046-508
26.8W corner / mid lumen	625x625	046-5051
42W corner / high lumen	625x625	046-5061

COVER	COLOUR TEMP.	SYSTEM POWER	DIRECT LUMENS	INDIRECT LUMENS	EFFICACY
mid lumen/	3000K	22W/m	1490lm/m	950lm/m	113lm/W
opal high p.	4000K		1440lm/m	1010lm/m	120lm/W
high lumen/	3000K	35W/m	2330lm/m	1520lm/m	108lm/W
opal high p.	4000K		2470lm/m	1610lm/m	115lm/W

BLIND CHANNEL / BLIND COVER

blind channel	custom	E 85031
blind cover	custom	E 80630

Accessories



END CAPS	ORDER CODE
TYPE	
end caps (pair)	046-501001



LINEAR CONNECTOR	ORDER CODE
TYPE	
linear connector (1 piece)	005-40046
linear connector (10 pieces)	005-40046.10
opal cover linear connector	006-14000



CABLE SUSPENSION / CANOPY

CABLE SUSPENSION / CANOPY	L (mm)	ORDER CODE
TYPE		
cable suspension	1500	005-2122110
canopy / feeder cable 3 × 1.5 mm ²	1500	005-221231
canopy / feeder cable 5 × 1.5 mm ²	1500	005-221241
cable rail	1200	005-2491110

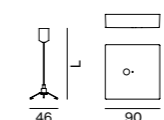

for electrical system configuration see luminaire data sheet at xal.com

THROUGH WIRE

THROUGH WIRE	ORDER CODE
TYPE	
3 × 1.5 mm ² (non DIM, 10 pieces)	004-90003
5 × 1.5 mm ² (DALI-2, 10 pieces)	004-90005



Feucht Mode Innsbruck, AT –
by blocher partners with lighting design
by Hallight Lichtplanung, Andreas Haidegger

Airport Singapore T4 Terminal
Singapore, SG – by Snohetta

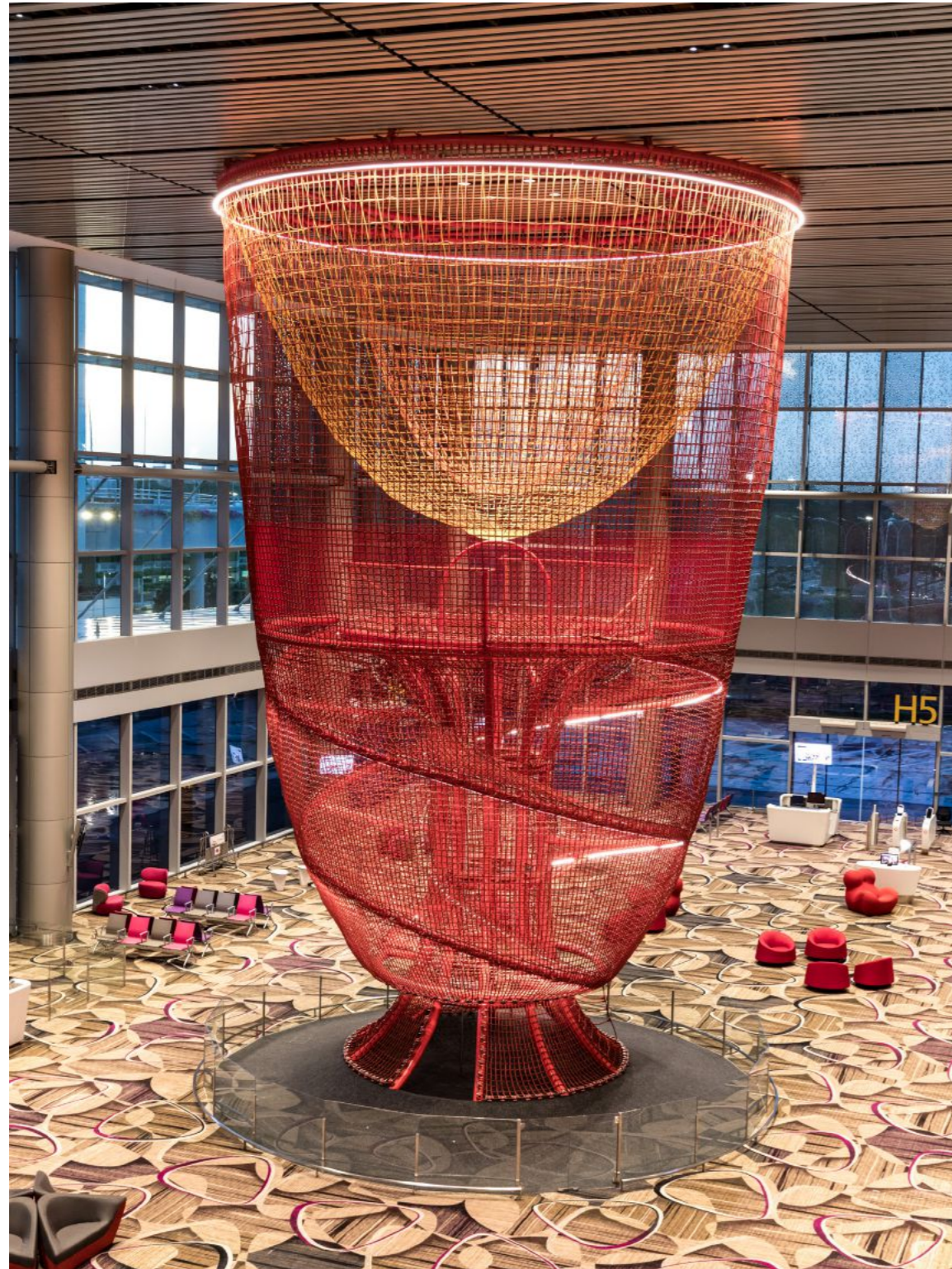



Novo Nordisk Zurich, CH

WKO Vienna, AT –
by Architekturconsult with lighting
design by Hailight Lichtplanung,
Andreas Haidegger



← back

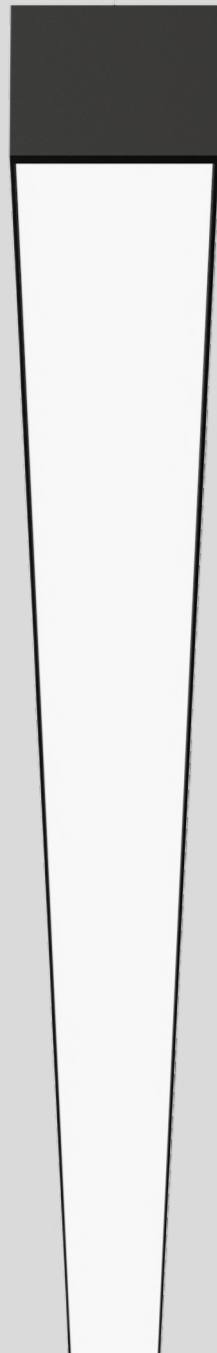

MINO 100 system

ceiling / suspended

EN Luminaire housing from extruded aluminium profile, angular design; no visible screws; for lighting systems; powder coated; luminaire profile for mounting available in advance; remaining components mounted without tools; pendant fitting with cable suspension; height adjustment without tools; spring clip attachment to the luminaire; with transparent feeder cable; light inset consisting of highly reflective coated extruded profile for improved thermal management; option: lighting module is versatile in length; HPO (High Performance Opal) cover for uniform illumination; micro prismatic PMMA diffuser incl. diffuser film for homogeneous illumination and reduced luminance; wallwasher light inset; energy-eff. LEDs – very good colour rendering

ES Cuerpo de perfil de aluminio con diseño angular; sin tornillos visibles; para sistemas de iluminación; recubierto de polvo; Perfil disponible para pre-montaje; los demás componentes se pueden montar sin herramientas; suspendido con cable; altura regulable sin herramientas; fijación en la lámpara por medio de clips elásticos; incl. cable de alimentación transparente; elemento de luz formado por perfil extruido con acabado altamente reflectante para una gestión térmica mejorada; elemento de luz opcional recortable a discreción; difusor opal de alta calidad que proporciona una iluminación uniforme; cubierta microprismática de PMMA con lámina difusora para la reducción de iluminancia y un alumbrado homogéneo; inserto bañador de pared; LED energét. efíc. – excelente reprod. crom.

Quickinfo

3000K, 4000K, TW
 CRI ≥ 80, CRI ≥ 90, 3 SDCM
 UGR ≤ 19 / 65° ≤ 3000 cd/m²
 up to 3090 lm/m
 up to 140 lm/W
 L90 @ 50 000h
 non DIM, DALI-2
 opal, microprismatic (UGR ≤ 19)

Types

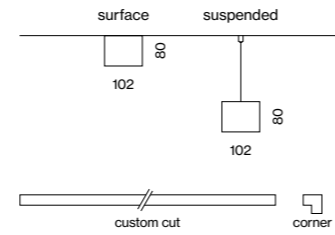

Colours



Light distributions



DiiA® standards
251, 252, 253



single luminaire
(p. 552)



wallwasher
inset (p. 944)



DIN EN 12464-1
UGR ≤ 19



flexible
inset

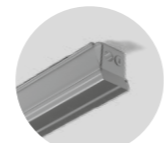

concrete install.
housing (p. 946)

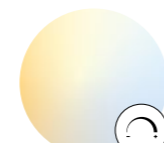

tunable white
2700–6500 K

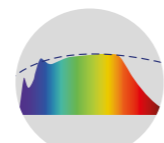

CRI ≥ 98
XPECTRUM

Order options

LED TYPE	
mid lumen	L
high lumen	M

COLOUR TEMPERATURE	
3000 K (CRI ≥ 90)	0
4000 K (CRI ≥ 90)	1
3000 K (CRI ≥ 80)	5
4000 K (CRI ≥ 80)	6
tunable white 2700–6500 K*	

*DALI-2 DT8

CONTROL	
non DIM	1
DALI-2 (only high lumen)	3

MATERIAL COLOUR	
pure white RAL 9010	7
white aluminium RAL 9006	G
jet black RAL 9005	8
special colours p. 992	X

LIGHT OPTIC COVER	
opal high performance	H
microprismatic	Z
microprismatic (UGR ≤ 19)*	G
blind cover**	B

*UGR ≤ 19 only with mid lumen
 **only for channel corner 90°

EMERGENCY LIGHT	
1h Accupack	N L 1
3h Accupack	N L 3

Options on request

COLOUR RENDERING INDEX	
CRI ≥ 98 XPECTRUM	

LUMINOUS FLUX value calculated for CRI ≥ 80, colour white, cover opal microprism. Z -8%, microprism. G -10%

MINO 100 ceiling /suspended

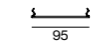
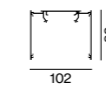

INSTALLATION CHANNEL /CORNER 90°	L (mm)	ORDER CODE
channel	1172	034-0126
channel	1472	034-0156
channel	3000	034-0306
channel	custom	E85050
channel corner 90° + cover	200x200	034-1266

LIGHT OPTIC COVER /BLIND COVER	L (mm)	ORDER CODE
linear	1171	006-12122
linear	1470	006-12152
linear	2997	006-12302
linear	custom	E80650
blind cover	3000	006-1130
blind cover	custom	E80650

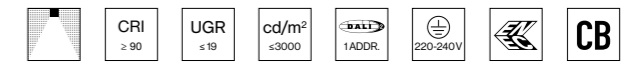

LIGHT INSET 100	L (mm)	ORDER CODE
SYSTEM POWER (MID/HIGH LUMEN)		
8.7/13.8 W	571	007-862
13/20.6 W	871	007-863
15.3/27.5 W	1171	007-864
19.2/34 W	1463	007-865
31/55 W	2341	007-868
38/68 W	2997	007-869
15.3/27.5 W flex	660-1171	007-86F
31/55 W flex	1903-2341	007-86G

COVER	COLOUR TEMP.	SYSTEM POWER	DELIVERED LUMENS	EFFICACY
mid lumen/opal	3000 K	14 W/m	1770 lm/m	132 lm/W
high performance	4000 K		1870 lm/m	140 lm/W
high lumen/opal	3000 K	24 W/m	2920 lm/m	123 lm/W
high performance	4000 K		3090 lm/m	130 lm/W

LIGHT INSET 100 tunable white 2700–6500 K	L (mm)	ORDER CODE
SYSTEM POWER		
21.7 W	871	007-8633D37
29 W	1171	007-8634D37
36 W	1463	007-8635D37
58 W	2341	007-8638D37

Accessories

END CAPS	ORDER CODE
TYPE	
end caps (pair)	034-1306

LINEAR CONNECTOR / THROUGH WIRE	ORDER CODE
TYPE	
linear connector (1 piece)	005-40066
linear connector (10 pieces)	005-40066.10
opal cover linear connector	006-10000
through wire 3 × 1.5 mm² (non DIM, 10 pieces)	004-90003
through wire 5 × 1.5 mm² (DALI-2, 10 pieces)	004-90005

CEILING CLIP /CABLE SUSPENSION /CANOPY	L (mm)	ORDER CODE
TYPE		
ceiling clip	10	034-11836
cable suspension	1500	005-2132110
canopy /feeder cable 3 × 1.5 mm²	1500	005-221231
canopy /feeder cable 5 × 1.5 mm²	1500	005-221241
cable rail	1200	005-2491110

for electrical system configuration see luminaire data sheet at xal.com

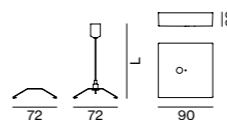
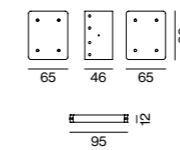
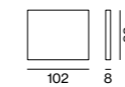
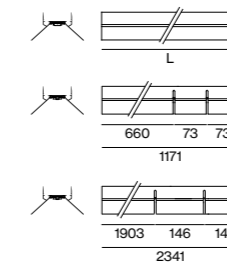



Office Amazon Prague, CZ –
by HLW with lighting design by U1 lighting

**Compound Semiconductor
Applications Catapult**
South Wales, UK –
by Monteith Scott



Adjust your profile system

BASO IP54 system

EN BASO IP54 is a powerful profile luminaire that has been specially adapted to demanding environmental conditions: from public outdoor areas to wet rooms. It has increased dust and insect protection (IP54). BASO IP54 is available as a single luminaire or as a system variant. It is easy to install and suitable for recessed or surface fitting as well as for wall or ceiling mounting. An opal cover delivers homogeneous basic illumination. The luminaire has a colour rendering of up to $CRI \geq 90$ and can be selected with a dark grey or white housing and in two light colours (3000 K and 4000 K).

ES BASO IP54 es una potente luminaria de perfil que se ha adaptado especialmente a las exigentes condiciones ambientales: pudiendo utilizarse en zonas exteriores públicas o espacios con alta humedad, entre otras muchas posibilidades. Además, está dotada de una elevada protección contra polvo e insectos (IP54). BASO IP54 está disponible como luminaria individual y como sistema, es fácil de montar y es apta tanto para la colocación empotrada o en superficie como para el montaje en pared o techo. Su difusor opal garantiza un alumbrado general homogéneo. Además, la luminaria ofrece una excelente reproducción cromática con de hasta $CRI \geq 90$ y puede elegirse en dos temperaturas de color (3000 K y 4000 K) y con carcasa blanca o en color gris oscuro.

Type



60

Mountings

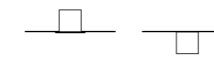
trim
recessed

surface

Configurations



linear

corner

Light distribution

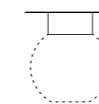

opal

← back



BASO 60 IP54 system

recessed with trim

EN Luminaire housing made of extruded aluminium; recessed luminaire with trim; suitable for ceiling thickness of 8-20 mm; surface powder coated; suitable for wall or ceiling mounting; luminaire profile (end caps come pre-assembled) can be pre-mounted; remaining luminaire components mounted without tools; closed light insert made of PMMA, consisting of converter unit and circuit board unit; light inset with screwed-on, thus maintenance-friendly, transparent end cap in PMMA; HPO (High Performance Opal) cover for uniform illumination; energy-efficient LEDs with very good colour rendering; IP 67 socket connector system for easy and sealed electrical connection

ES Cuerpo de lámpara de perfil extrusionado de aluminio; luminaria empotrable con marco; para sistemas de iluminación continuos; apropiada para grosores de techo entre 8-20mm; superficie con recubrimiento de pintura en polvo; apropiada para montaje en techo y paredes; perfil de luminaria premontable; resto de componentes luminosos montables sin herramienta; elemento de luz cerrado de PMMA, compuesto de convertidor y pletina; elemento de luz con tapa terminal transparente de metacrilato atornillada y de fácil mantenimiento; difusor opal de alta calidad que proporciona una iluminación uniforme; LEDs de alta eficiencia que proporcionan una alta reproducción cromática; conector con casquillo IP67 para realizar una conexión eléctrica estanca

Quickinfo

3000K, 4000K
 CRI ≥ 80, 3 SDCM
 up to 2340 lm/m
 up to 125 lm/W
 L90 @ 50 000h
 DALI-2
 opal, IP 54

Types

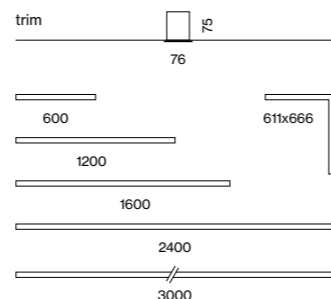

Colours



Light distribution

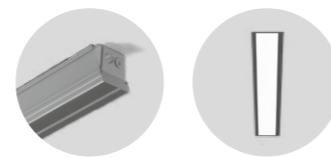

concrete install. housing (p.946) single luminaire housing (p.558)

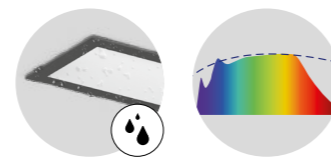

dust & splash water protection (IP54) CRI ≥ 98 XPECTRUM

Order options

COLOUR TEMPERATURE	
3000K	5
4000K	6

CONTROL
 DALI-2

MATERIAL COLOUR	
○ traffic white RAL 9016	7
● umbra grey RAL 7022	D

LIGHT OPTIC COVER
 opal high performance

Options on request

COLOUR RENDERING INDEX
 CRI ≥ 90

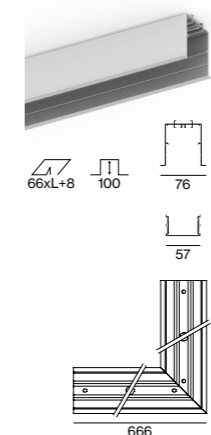

BASO 60 IP54 trim

INSTALLATION CHANNEL / CORNER 90° / BLIND COVER	L (mm)	ORDER CODE
channel	600	845-340201
channel	1200	845-340401
channel	1600	845-340501
channel	2400	845-340801
channel	3000	845-340901
corner connector 90°	611x666	845-341121
blind cover	600	006-330601
blind cover	1200	006-331201
blind cover	1600	006-331601
blind cover	2400	006-332401
blind cover	3000	006-333001

order installation channel, light inset + mounting accessories separately

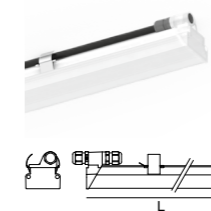

LIGHT INSET 60 IP54



SYSTEM POWER	L (mm)	ORDER CODE
11.2W start/run	599	845-4042::30H
22.4W start/run	1198	845-4044::30H
29.9W start/run	1597	845-4045::30H
45W start/run	2396	845-4048::30H
11.2W end	599	845-4052::30H
22.4W end	1198	845-4054::30H
29.9W end	1597	845-4055::30H
45W end	2396	845-4058::30H

COVER	COLOUR TEMP.	SYSTEM POWER	DELIVERED LUMENS	EFFICACY
opal high performance	3000K	18.8W/m	2210lm/m	118lm/W
	4000K	18.8W/m	2340lm/m	124lm/W

Accessories

END CAPS	ORDER CODE
end caps (pair)	845-341001

MOUNTING BRACKET	ORDER CODE
mounting bracket (1 piece)	045-3412010
mounting bracket (10 pieces)	045-3412010.10

LINEAR CONNECTOR	ORDER CODE
linear connector (1 piece)	045-4011110
linear connector (10 pieces)	045-4011110.10

FEEDER CABLE / EXTENSION CABLE / CONNECTOR	L (mm)	ORDER CODE
feeder cable 2x1.5+2x0.75 mm ²	2000	845-4013240
feeder cable 2x1.5+2x0.75 mm ²	4000	845-4013440
extension cable 2x1.5+2x0.75 mm ²	1200	845-4014140
mini connector 4-pole	-	845-4013040

LUMINOUS FLUX value calculated for CRI ≥ 80, colour white, cover opal

SNS Headquarters
Moscow, RU –
by ABD Architects with lighting
design by Light & Design



← back

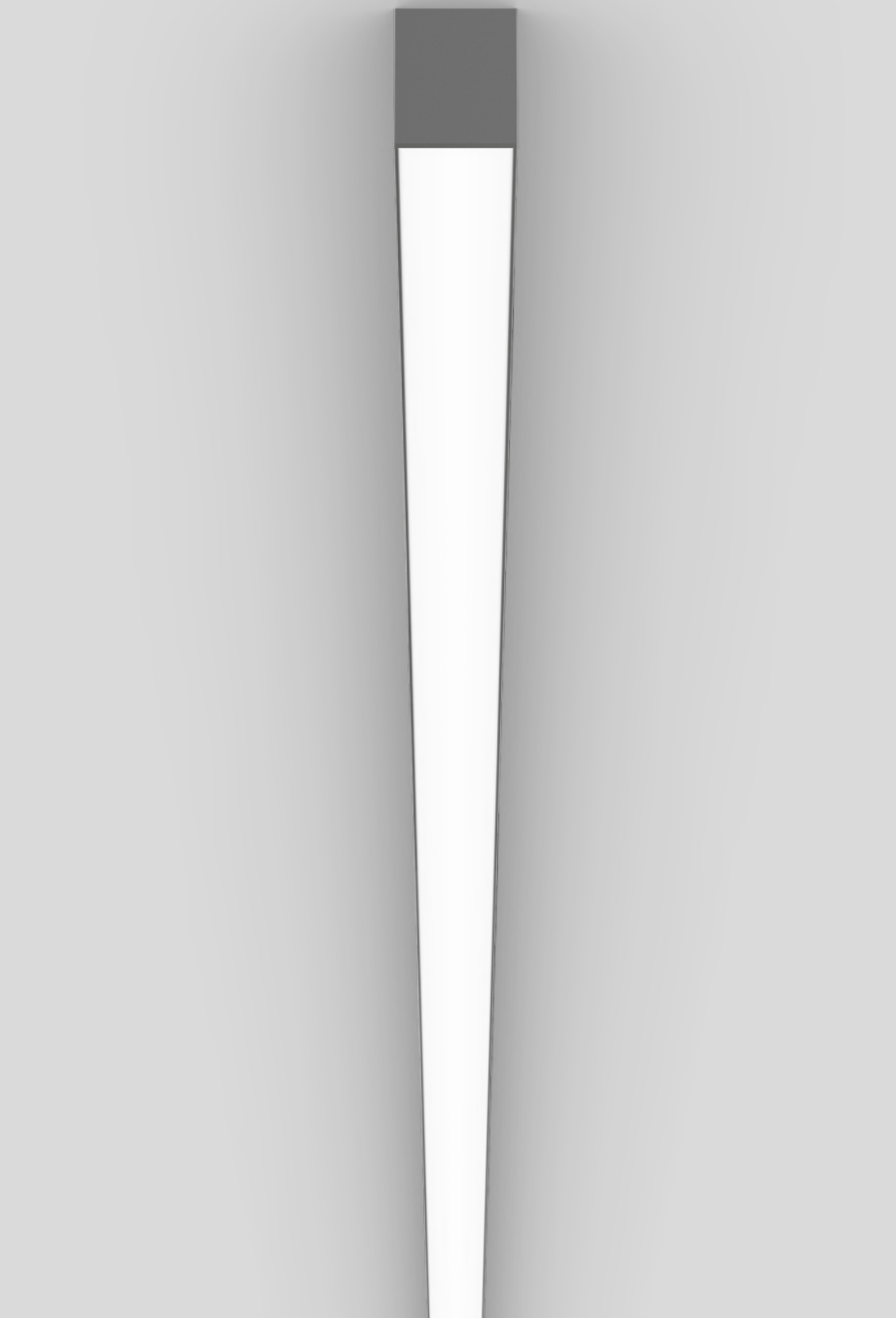

BASO 60 IP54 system surface

EN Luminaire housing from extruded aluminium profile, angular design; light-tight end caps in aluminium, no visible screws; surface powder coated; suitable for wall or ceiling mounting; luminaire profile (end caps come pre-assembled) can be pre-mounted; remaining luminaire components mounted without tools; closed light insert made of PMMA, consisting of converter unit and circuit board unit; light inset with screwed-on, thus maintenance-friendly, transparent end cap in PMMA; HPO (High Performance Opal) cover for uniform illumination; energy-efficient LEDs with very good colour rendering; IP67 socket connector system for easy and sealed electrical connection

ES Cuerpo de perfil de aluminio con diseño angular; tapa terminal de aluminio con cierre estanco, ningún tornillo visible; para sistemas de iluminación continuos; superficie con recubrimiento de pintura en polvo; apropiada para montaje en techo y paredes; perfil de luminaria premontable; resto de componentes luminosos montables sin herramienta; elemento de luz cerrado de PMMA, compuesto de convertidor y pletina; elemento de luz con tapa terminal transparente de metacrilato atornillada y de fácil mantenimiento; difusor opal de alta calidad que proporciona una iluminación uniforme; LEDs de alta eficiencia que proporcionan una alta reproducción cromática; conector con casquillo IP67 para realizar una conexión eléctrica estanca

Quickinfo

3000K, 4000K
 CRI ≥ 80, 3 SDCM
 up to 2340lm/m
 up to 125lm/W
 L90 @ 50 000h
 DALI-2
 opal, IP54

Types

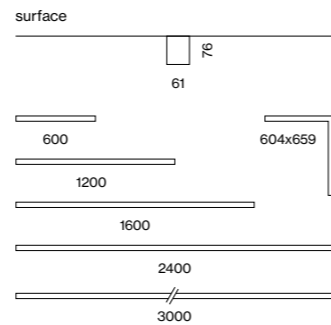

Colours



Light distribution



direct



quick installation

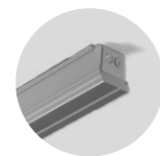

concrete install. housing (p.946)



single luminaire housing (p.558)



dust & splash water protection (IP54)

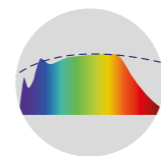

CRI ≥ 98 XPECTRUM

Order options

COLOUR TEMPERATURE	
3000K	5
4000K	6

CONTROL

DALI-2

MATERIAL COLOUR

- traffic white RAL 9016 7
- umbra grey RAL 7022 D

LIGHT OPTIC COVER

opal high performance

Options on request

COLOUR RENDERING INDEX

CRI ≥ 90

MOUNTING

concrete installation housing

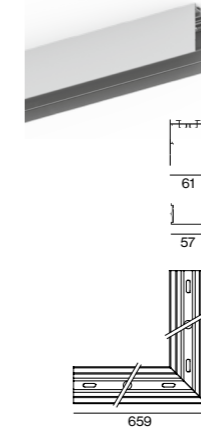

BASO 60 IP54 surface

INSTALLATION CHANNEL / CORNER 90° / BLIND COVER

TYPE	L (mm)	ORDER CODE
channel	600	845-400201
channel	1200	845-400401
channel	1600	845-400501
channel	2400	845-400801
channel	3000	845-400901
corner connector 90°	604x659	845-401121
blind cover	600	006-330601
blind cover	1200	006-331201
blind cover	1600	006-331601
blind cover	2400	006-332401
blind cover	3000	006-333001

order installation channel, light inset + mounting accessories separately

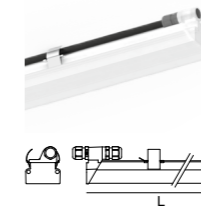

LIGHT INSET 60 IP54



SYSTEM POWER	L (mm)	ORDER CODE
11.2W start/run	599	845-4042::30H
22.4W start/run	1198	845-4044::30H
29.9W start/run	1597	845-4045::30H
45W start/run	2396	845-4048::30H
11.2W end	599	845-4052::30H
22.4W end	1198	845-4054::30H
29.9W end	1597	845-4055::30H
45W end	2396	845-4058::30H

COVER	COLOUR TEMP.	SYSTEM POWER	DELIVERED LUMENS	EFFICACY
opal high performance	3000K	18.8W/m	2210lm/m	118lm/W
	4000K	18.8W/m	2340lm/m	124lm/W

Accessories

END CAPS

TYPE	ORDER CODE
end caps (pair)	845-401001

LINEAR CONNECTOR

TYPE	ORDER CODE
linear connector (1 piece)	045-4011110
linear connector (10 pieces)	045-4011110.10

FEEDER CABLE / EXTENSION CABLE / CONNECTOR

TYPE	L (mm)	ORDER CODE
feeder cable 2x1.5+2x0.75 mm ²	2000	845-4013240
feeder cable 2x1.5+2x0.75 mm ²	4000	845-4013440
extension cable 2x1.5+2x0.75 mm ²	1200	845-4014140
mini connector 4-pole	-	845-4013040

LUMINOUS FLUX value calculated for CRI ≥ 80, colour white, cover opal

Sekundarschule Petermoos
Zurich, CH – by Itten+Brechbühl
AG, Christina Hamming
including lighting design



← back



Quickinfo

3000K, 4000K
CRI ≥ 80, 3 SDCM
up to 96lm/W
L80 @ 50 000h
non DIM, DALI-2

Types

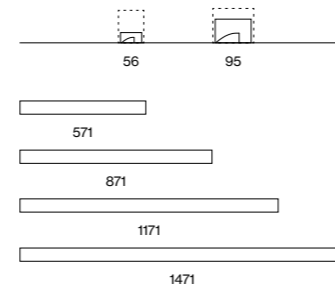

Colours



Light distribution



WALLWASHER

inset 60/100

EN Lighting module with specially computed, asymmetrical high gloss reflector for homogeneous vertical lighting; lighting module in aluminium, powder coated, installation without tools

ES Elemento de luz con reflector asimétrico de alto brillo, especialmente calculado para la iluminación vertical homogénea; elemento de luz de aluminio con recubrimiento de polvo, puede montarse sin herramientas

Order options

COLOUR TEMPERATURE	
3000K	5
4000K	6

CONTROL	
non DIM	1
DALI-2	3

MATERIAL COLOUR	
<input type="radio"/> pure white RAL 9010	7
<input checked="" type="radio"/> white aluminium RAL 9006	G
<input type="radio"/> jet black RAL 9005	8

LIGHT OPTIC
wallwasher

Planning information

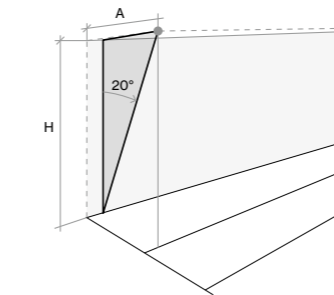

MOUNTING DISTANCE

H (mm)	A (mm)
2750	900
3000	1000
3500	1200

Light distribution

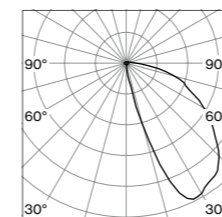

asymmetric

LUMINOUS FLUX value calculated for CRI ≥ 80, colour white, reflector chrome

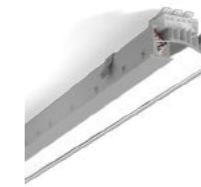

INSET 60 wallwasher



LIGHT INSET only for recessed or surface mounting

SYSTEM POWER	L (mm)	ORDER CODE
10.6 W	571	007-9042
14 W	871	007-9043
18.7 W	1171	007-9044
28 W	1471	007-9045

Technical data

SYSTEM POWER	COLOUR TEMPERATURE	DELIVERED LUMENS	EFFICACY
17 W/m	3000K	1960 lm/m	121 lm/W
	4000K	2070 lm/m	128 lm/W

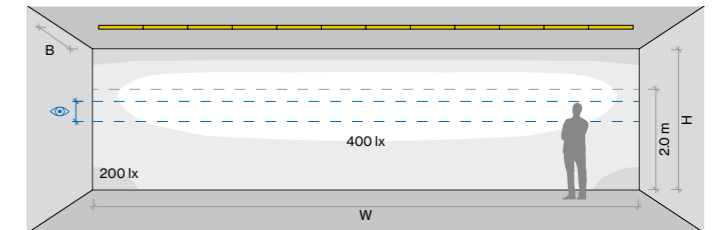

INSET 60 wallwasher, 18.7W, 3000K

CALCULATION SURFACE
Surface dimensions 10.8 × 2.8 m
Surface height 0 – 2.8 m
Eye level 0.7 | 0.5 | 0.2

ROOM VALUES
Wall dimensions H = 2.8 m | W = 10.8 m
Distance to wall B = 1.3 m
Distance between luminaires continuous
Reflection factor 0.7 | 0.5 | 0.2
Maintenance factor 0.8

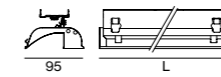

INSET 100 wallwasher



LIGHT INSET

SYSTEM POWER	L (mm)	ORDER CODE
20 W	571	007-9052
30 W	871	007-9053
40 W	1171	007-9054
51 W	1463	007-9055

CABLE SUSPENSION

TYPE	L (mm)	ORDER CODE
inset 100 wallwasher	1500	005-2132310

installation channel is required for mounting

Technical data

SYSTEM POWER	COLOUR TEMPERATURE	DELIVERED LUMENS	EFFICACY
35 W/m	3000K	2820 lm/m	82 lm/W
	4000K	2990 lm/m	87 lm/W

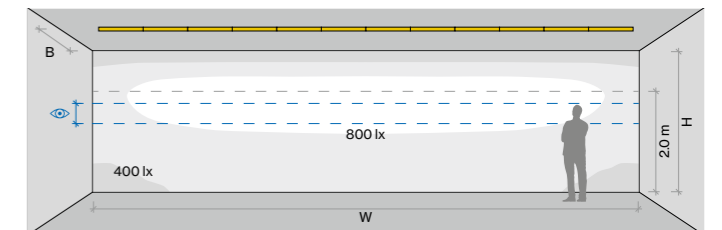

INSET 100 wallwasher, 30W, 3000K

CALCULATION SURFACE
Surface dimensions 10.8 × 2.8 m
Surface height 0 – 2.8 m
Eye level 0.7 | 0.5 | 0.2

ROOM VALUES
Wall dimensions H = 2.8 m | W = 10.8 m
Distance to wall B = 1.3 m
Distance between luminaires continuous
Reflection factor 0.7 | 0.5 | 0.2
Maintenance factor 0.8

← back

Order options

NUMBER OF PIECES	
2 pieces	2
3 pieces	3

FRAME 40/MINO 40

HOUSING FOR CONCRETE INSTALLATION

TYPE	L (mm)	ORDER CODE
FRAME 40 trim	3010	0 0 5 - 4 1 3 5 6
MINO 40	3010	0 0 5 - 4 1 3 5 6

MOUNTING SET

TYPE	ORDER CODE
FRAME 40 trim	0 3 5 - 0 6 0 2
MINO 40	0 3 4 - 0 6 0 2

up to 900 mm: 2 pieces / up to 1500 mm: 3 pieces / up to 3000 mm: 2 x 2 pieces

END CAPS

TYPE	ORDER CODE
end caps (pair)	0 0 5 - 4 1 2 3 6

LINEAR CONNECTOR

TYPE	ORDER CODE
linear connector (1 piece)	0 0 5 - 4 1 1 6 6
linear connector (10 pieces)	0 0 5 - 4 1 1 6 6 . 1 0

CORNER CONNECTOR 90°

TYPE	L (mm)	ORDER CODE
FRAME 40 trim	140	0 3 5 - 0 6 0 1 6
MINO 40	140	0 3 5 - 0 6 0 1 6

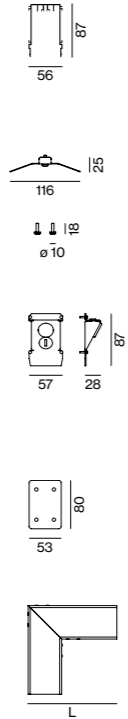

Order options

NUMBER OF PIECES	
2 pieces	2
3 pieces	3

FRAME 60/MINIMAL 60/MINO 60/BASO 60

HOUSING FOR CONCRETE INSTALLATION

TYPE	L (mm)	ORDER CODE
FRAME 60 trim	3000	0 0 5 - 4 1 3 4 6
BASO 60 IP54 trim	3000	0 0 5 - 4 1 3 4 6
MINIMAL 60 trimless	3000	0 0 5 - 4 1 3 4 6
MINO 60 ceiling	3000	0 0 5 - 4 1 4 4 6
BASO 60 IP54 surface	3000	0 0 5 - 4 1 4 4 6

MOUNTING SET

TYPE	ORDER CODE
FRAME 60 trim	0 3 5 - 0 6 0 0
BASO 60 IP54 trim	0 3 5 - 0 6 0 0
MINIMAL 60 trimless	0 3 6 - 0 4 0 0
MINO 60 ceiling	0 3 4 - 0 4 0 0
BASO 60 IP54 surface	0 3 4 - 0 4 0 0

up to 900 mm: 2 pieces / up to 1500 mm: 3 pieces / up to 3000 mm: 2 x 2 pieces

END CAPS

TYPE	ORDER CODE
end caps (pair)	0 0 5 - 4 1 2 4 6

LINEAR CONNECTOR

TYPE	ORDER CODE
linear connector (1 piece)	0 0 5 - 4 1 1 6 6
linear connector (10 pieces)	0 0 5 - 4 1 1 6 6 . 1 0

CORNER CONNECTOR 90°

TYPE	L (mm)	ORDER CODE
FRAME 60 trim	142	0 3 5 - 0 4 0 1 6
BASO 60 IP54 trim	142	0 3 5 - 0 4 0 1 6
MINIMAL 60 trimless	146	0 3 6 - 0 4 0 1 6
MINO 60 ceiling	157	0 3 4 - 0 4 0 1 6
BASO 60 IP54 surface	157	0 3 4 - 0 4 0 1 6

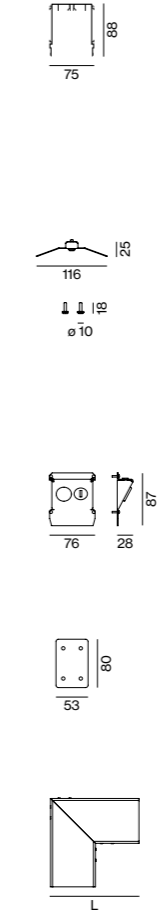

FRAME 100/MINIMAL 100/MINO 100

HOUSING FOR CONCRETE INSTALLATION

TYPE	L (mm)	ORDER CODE
FRAME 100 trim	3000	0 0 5 - 4 1 3 6 6
MINIMAL 100 trimless	3000	0 0 5 - 4 1 3 6 6
MINO 100 ceiling	3000	0 0 5 - 4 1 4 6 6

MOUNTING SET

TYPE	ORDER CODE
FRAME 100 trim	0 3 5 - 0 6 0 0
MINIMAL 100 trimless	0 3 6 - 0 5 0 0
MINO 100 ceiling	0 3 4 - 0 4 0 0

up to 900 mm: 2 pieces / up to 1500 mm: 3 pieces / up to 3000 mm: 2x2 pieces

END CAPS

TYPE	ORDER CODE
end caps (pair)	0 0 5 - 4 1 2 6 6

LINEAR CONNECTOR

TYPE	ORDER CODE
linear connector (1 piece)	0 0 5 - 4 1 1 6 6
linear connector (10 pieces)	0 0 5 - 4 1 1 6 6 . 1 0

CORNER CONNECTOR 90°

TYPE	L (mm)	ORDER CODE
FRAME 100 trim	202	0 3 5 - 0 5 0 1 6
MINIMAL 100 trimless	207	0 3 6 - 0 5 0 1 6
MINO 100 ceiling	207	0 3 4 - 0 5 0 1 6

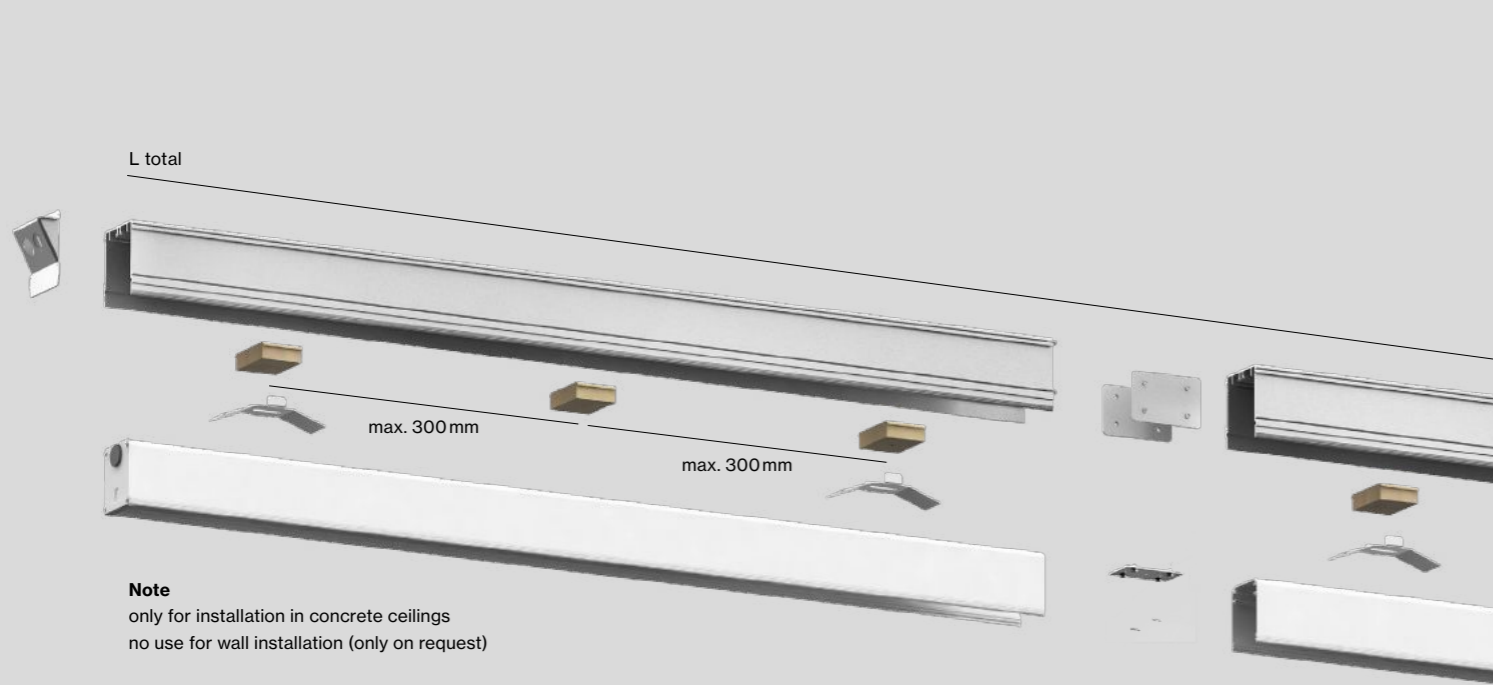
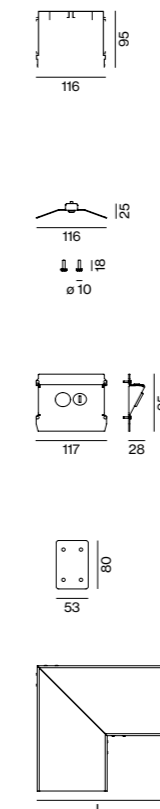

L total

max. 300mm

max. 300mm

Note
only for installation in concrete ceilings
no use for wall installation (only on request)

CONCRETE installation housing

EN Concrete casting made of aluminium profile, designed for continuous lighting systems

ES Carcasa empotrable en hormigón de perfil aluminio, diseñada para sistemas iluminación continuos

Perfect allrounder

TUBO system

EN As a system luminaire, TUBO scores as a uniform and pleasant lighting system brought to life by linear connecting elements. The luminaire is available for wall and ceiling mounting, as well as in a suspended pendant version. Thanks to the opal cover, the TUBO System luminaire provides uniform ambient lighting and a pleasant atmosphere in entrance areas, corridors, and public spaces. The characteristic beam angle of up to 340° brightens the ceiling slightly while the available light colours 3000K and 4000K boost this positive room atmosphere.

ES En su variante modular, TUBO permite obtener un sistema de iluminación agradable y uniforme mediante la unión de elementos de conexión lineales. La luminaria también está disponible para el montaje en pared o techo y como variante de suspensión. Su difusor opal hace que la luminaria modular TUBO pueda ofrecer un alumbrado general homogéneo y un ambiente agradable en áreas de entrada, pasillos y zonas públicas. Su ángulo de proyección característico de hasta 340° garantiza una suave iluminación del techo, y las temperaturas de color de 3000K y 4000K disponibles contribuyen a la obtención de una atmósfera interior atractiva.

Types



60

100

Mountings

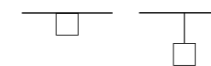

surface

suspended

Light distribution



opal

340° light distribution

EN With its 340° beam pattern and opal cover, TUBO System delivers homogeneous illumination as well as slight ceiling brightening. This makes the system luminaire perfect for places where pleasant ambient lighting is desired, such as reception areas, corridors, or foyers.

ES Con su ángulo de proyección de 340° y su difusor opal, TUBO System ofrece un alumbrado homogéneo unido a una iluminación ligera del techo. Por eso, esta luminaria modular es perfecta para lugares en los que se desea contar con una iluminación general agradable, como zonas de recepción, pasillos y vestíbulos.

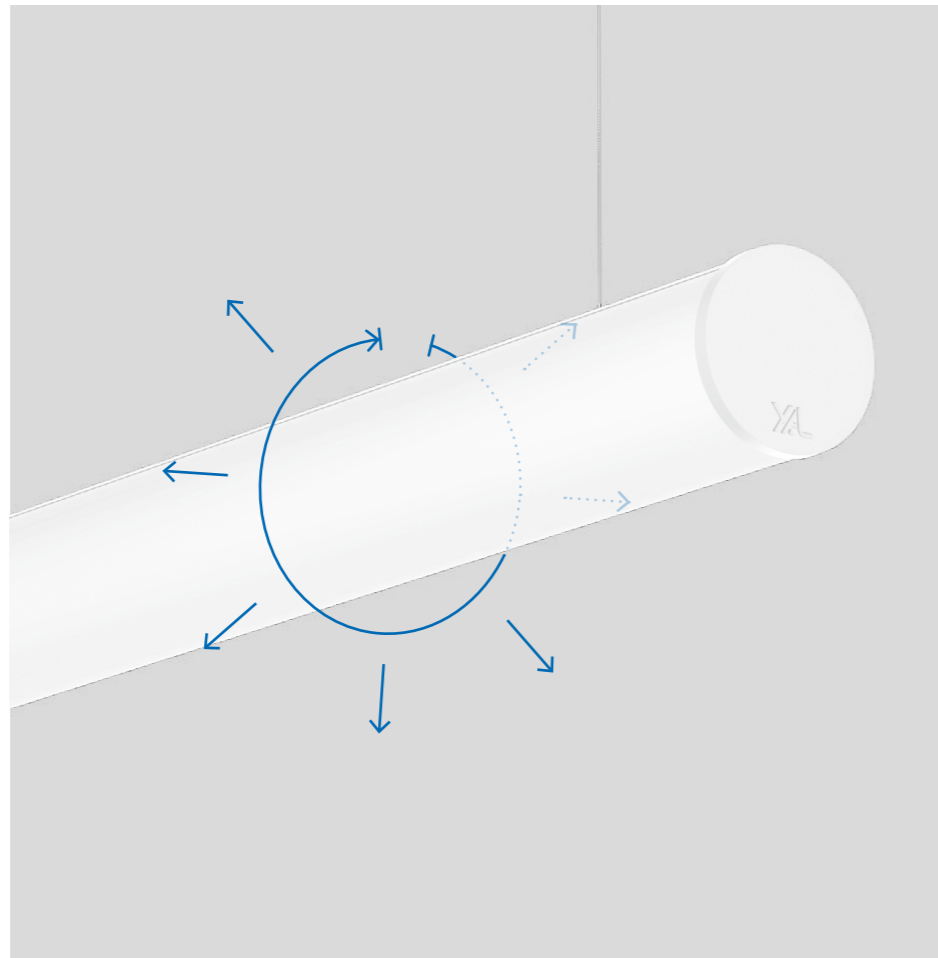

Mounting options

EN The TUBO System can be installed as a surface-mounted version in a continuous lighting system for walls and ceilings, or as a suspended pendant luminaire on the ceiling.

ES TUBO System puede instalarse como sistema de iluminación continuo en su variante de superficie para el montaje en techos o paredes o como luminaria pendular suspendida en el techo.



Seamless light channel

EN TUBO as a continuous lighting system: Connecting elements can turn individual TUBO luminaires into a seamless channel. This creates a visually uniform lighting system for many different applications – whether as a corridor luminaire, effect luminaire, or visual guidance system.

ES TUBO como sistema de iluminación continuo: los elementos de unión permiten convertir las distintas luminarias TUBO en un sistema de luz ininterrumpido. Esto crea un sistema visualmente uniforme para tipos de uso muy diversos, ya sea como luminaria de pasillo, luz de efecto o sistema de direccionamiento visual.



Easy mounting

EN TUBO 60 system luminaires are electrically connected by a simple plug-in connection. This makes the installation of a complex lighting system simple, quick, and straightforward.

ES Las luminarias modulares TUBO 60 se conectan eléctricamente con una simple conexión enchufable. Con ello, el montaje de un sistema de iluminación completo puede realizarse de un modo muy sencillo, rápido y sin complicaciones.

← back



TUBO 60 system

surface / suspended

EN Supporting profile in extruded aluminium; end cap in aluminium; for continuous lighting systems; surface powder coated; surface mounted or suspended luminaire with cable suspension; height adjustment without tools; with transparent feeder cable; electrical connection of the luminaires via plug / socket system; no separate wiring required; light control via high-quality lens system for maximum, homogeneous illumination; completely homogeneously illuminated, cylindrical HPO (High Performance Opal) cover; energy-efficient LEDs with very good colour rendering

ES Perfil soporte fabricado en aluminio; tapas finales de aluminio; para sistemas de iluminación continuos; superficie con recubrimiento de pintura en polvo; lámpara superpuesta o lámpara colgante con cable; altura regulable sin herramientas; incl. cable de alimentación transparente; unión eléctrica de las luminarias con conexión macho/hembra; sin cableado adicional; direccionam. de luz con óptica de lente alta calid. para alumbr. techo máx. y homog.; difusor HPO (High Performance Opal) de alumbrado totalmente homogéneo; LEDS de alta eficiencia que proporcionan una alta reproducción cromática



single luminaire (p. 572)

uniform illumination

Quickinfo

3000K, 4000K
CRI ≥ 80, 3 SDCM
up to 3160lm/m
up to 114lm/W
L90 @ 50 000h
non DIM, DALI-2
opal

Types

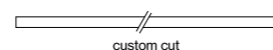
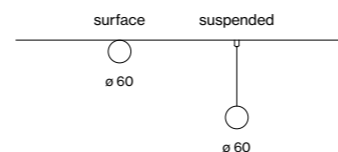

Colour



Light distributions



Order options

COLOUR TEMPERATURE	
3000K	5
4000K	6

CONTROL	
non DIM	1
DALI-2	3

MATERIAL COLOUR

○ pure white RAL 9010

TUBO 60 surface/suspended



INSTALLATION CHANNEL + LIGHT INSET + LIGHT OPTIC COVER				
SYS. POWER	COLOUR TEMP.	LUM. FLUX	L (mm)	ORDER CODE
16.5 W	3000K	1780lm	585	058-3022::70
	4000K	1880lm		
33 W	3000K	3560lm	1185	058-3024::70
	4000K	3760lm		
66 W	3000K	7110lm	2385	058-3028::70
	4000K	7530lm		
82 W	3000K	8890lm	2985	058-3029::70
	4000K	9410lm		

Accessories surface

END CAP / POWER FEEDER

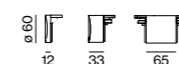

TYPE	ORDER CODE
end cap	058-3010017
end cap power feeder	058-3010217
middle power feeder	058-3011217

LINEAR CONNECTOR

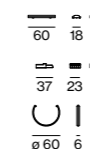

TYPE	ORDER CODE
mechanical	058-3013117
mechanical & electrical	058-3013127
incl. opal cover connector	

CEILING MOUNTING SET



TYPE	L (mm)	ORDER CODE
ceiling mounting set	75	058-3014117

Accessories suspended

END CAP / POWER FEEDER incl. feeder cable

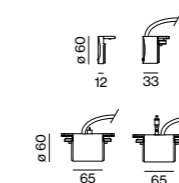

TYPE	ORDER CODE
end cap	058-3010017
end cap power feeder 5 × 1.5 mm ²	058-3010417
middle power feeder* 5 × 1.5 mm ²	058-3011317
middle power feeder angular** 5 × 1.5 mm ²	058-3011327

*incl. cable suspension 1500 mm

**incl. cable suspension angular max. 60° 1500 mm

LINEAR CONNECTOR

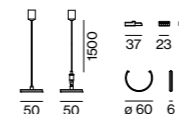

TYPE	ORDER CODE
mechanical*	058-3013217
mechanical angular**	058-3013317
mechanical & electrical*	058-3013227
mechanical & electrical angular**	058-3013327

incl. opal cover connector

*incl. cable suspension 1500 mm

**incl. cable suspension angular max. 60° 1500 mm

CABLE SUSPENSION

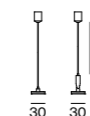

TYPE	L (mm)	ORDER CODE
cable suspension	1500	058-3014210
cable suspension angular max. 60°	1500	058-3014310

CANOPY



TYPE	Ø-H (mm)	ORDER CODE
non DIM / DALI-2	90-22	005-2600037

for electrical system configuration see luminaire data sheet at xal.com

LUMINOUS FLUX value calculated for CRI ≥ 80, colour white, cover opal

← back



TUBO 100 system

surface / suspended

EN Supporting profile in extruded aluminium; end cap in aluminium, no visible screws; for lighting systems; powder coated; luminaire profile for mounting available in advance; remaining components mounted without tools; surface mounted or suspended luminaire with cable suspension; height adjustment without tools; spring clip attachment to the luminaire; freely positionable; with transparent feeder cable; light inset consisting of highly reflective coated extruded profile for improved thermal management; cylindrical cover made of satinised PMMA for homogeneous illumination; with 340° light emission and light ceiling illumination; energy-eff. LEDs – very good colour rendering

ES Perfil soporte fabricado en aluminio; tapas finales de aluminio sin tornillos visibles; para sistemas de iluminación; recubierto de polvo; Perfil disponible para pre-montaje; los demás componentes se pueden montar sin herramientas; lámpara superpuesta o lámpara colgante con cable; altura regulable sin herramientas; fijación en las lámparas por medio de enganches elásticos; ajustable de una manera sencilla; incl. cable de alimentación transparente; elemento de luz formado por perfil extruido con acabado altamente reflectante para una gestión térmica mejorada; cubierta cilíndrica de PMMA satinada para iluminación homogénea; con 340° de emisión e iluminación de techo; LED energét. efic. – excelente reprod. crom.



single luminaire (p. 576)

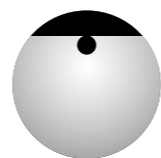

uniform illumination

Types

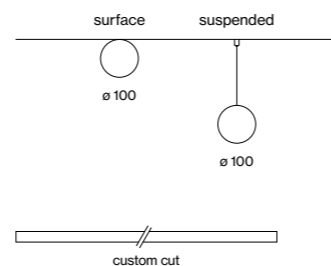

Colour



Light distributions



direct direct

Quickinfo

3000K, 4000K
CRI ≥ 80, 3 SDCM
up to 4300lm/m
up to 138lm/W
L90 @ 50 000h
non DIM, DALI-2
opal

Order options

COLOUR TEMPERATURE	
3000K	5
4000K	6

CONTROL	
non DIM	1
DALI-2	3

MATERIAL COLOUR

○ pure white RAL 9010

Options on request

CONTROL	
Casambi	

EMERGENCY LIGHT

1h Accupack	
3h Accupack	

only available for length 1463mm



TUBO 100 ceiling / suspended

INSTALLATION CHANNEL

TYPE	L (mm)	ORDER CODE
installation channel	582	029-00667
installation channel	882	029-00967
installation channel	1182	029-01267
installation channel	1482	029-01567
installation channel	2364	029-02567
installation channel	3000	029-03067
installation channel	custom	E85950 ···· 7

LIGHT OPTIC COVER OPAL HIGH PERFORMANCE

TYPE	L (mm)	ORDER CODE
light optic cover	577	006-5205700
light optic cover	877	006-5208700
light optic cover	1177	006-5211700
light optic cover	1477	006-5214700
light optic cover	2359	006-5223400
light optic cover	2995	006-5230000
light optic cover	custom	E85910 ···· 00



LIGHT INSET

SYSTEM POWER	L (mm)	ORDER CODE
18.3 W	571	029-8832 ··· 7
27.5 W	871	029-8833 ··· 7
37 W	1171	029-8834 ··· 7
46 W	1463	029-8835 ··· 7
73 W	2341	029-8838 ··· 7

COVER	COLOUR TEMP.	SYSTEM POWER	DELIVERED LUMENS	EFFICACY
opal high	3000K	31W/m	4060lm/m	131lm/W
performance	4000K		4300lm/m	138lm/W

Accessories

END CAPS

TYPE	ORDER CODE
end caps (pair)	029-14067

LINEAR CONNECTOR

TYPE	ORDER CODE
linear connector (1 piece)	029-12027
linear connector (10 pieces)	029-12027.10
opal cover linear connector	029-12927
anti-slip protection (per cover)	029-00347

MOUNTING

TYPE	L (mm)	ORDER CODE
ceiling mounting set	40	029-00446
cable suspension	1500	005-2142110
angular cable susp. (max. 60°)	1500	005-2142210
canopy / feeder cable 3 × 1.5 mm ²	1500	005-2222317
canopy / feeder cable 5 × 1.5 mm ²	1500	005-2222417
cable rail	1200	005-2491110

for electrical system configuration see luminaire data sheet at xal.com

THROUGH WIRE

TYPE	ORDER CODE
3 × 1.5 mm ² (non DIM, 10 pieces)	004-90003
5 × 1.5 mm ² (DALI-2, 10 pieces)	004-90005

LUMINOUS FLUX value calculated for CRI ≥ 80, colour white, cover opal



UK TV
London, UK –
by PENSON with lighting
design by AECOM

Define the horizon



LINEA system

EN Elegant room accentuation, highest performance. LINEA is a reduced, convertible luminaire for stylish wall, floor, and ceiling illumination. The extraordinarily narrow wall profile is completed by various lighting insets. Different beam patterns can be easily combined. For example, an opal cover for homogeneous illumination and asymmetrical illumination for brightening floors or ceilings. Spotlights can be chosen for elegant accentuation or as reading lights. LINEA is available as an individual decorative luminaire in different lengths, including perpendicular corner elements. Choose between white and black for the profile. The inserts optionally have a colour rendering of up to $CRI \geq 98$. In addition, the light inserts themselves can be selected in the light colours 2700 K, 3000 K, 4000 K, or as a Tunable White option.

ES Acentuación elegante del espacio con el máximo rendimiento: LINEA system es una luminaria minimalista pero versátil, apta para la iluminación refinada de paredes, suelos y techos. El perfil extraordinariamente estrecho se completa con diversos elementos de luz. La fijación a la cara superior y/o inferior del perfil se realiza magnéticamente, por lo que los elementos pueden intercambiarse con toda facilidad. Es posible combinar entre sí distintos modos de proyección, por ejemplo, utilizando un difusor opal para un alumbrado homogéneo, un Wall Grazer para la acentuación de paredes o la iluminación asimétrica para el tamizado de suelos o techos. LINEA system se ofrece en tres longitudes como luminaria individual decorativa o en una versión de sistema con elementos de esquina rectangulares. Los perfiles están disponibles en color blanco, negro y colores especiales. Por su parte, los aparatos pueden elegirse en temperaturas de color de 2700 K, 3000 K o 4000 K y sustituirse en cualquier momento en función de las necesidades.

Mounting

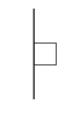

wall

Configurations



linear



corner

Light distributions

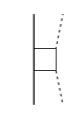
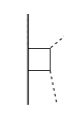
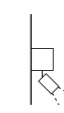
opal
opalasymmetric
opal

spot

← back

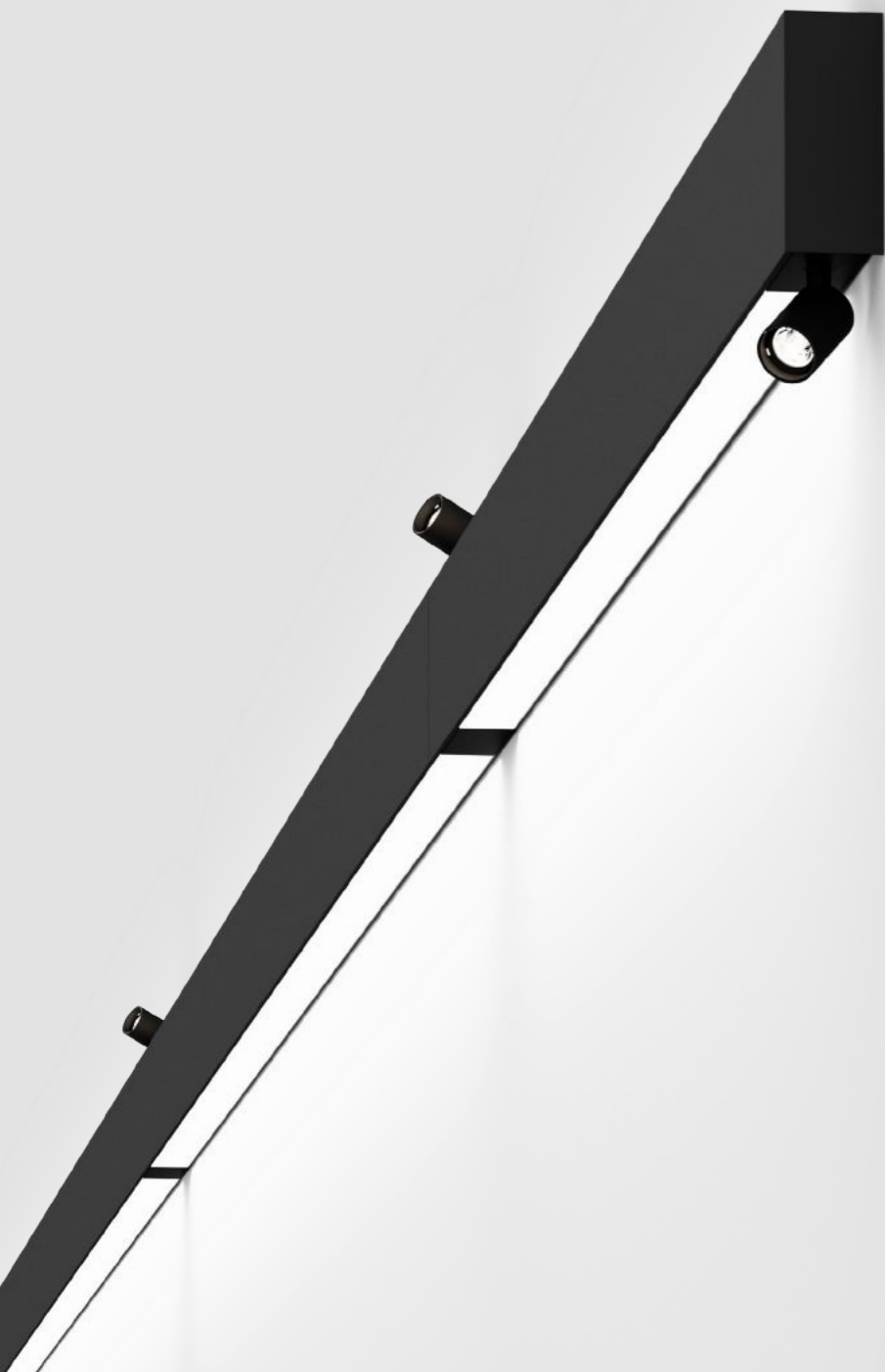

LINEA system

wall

EN Luminaire housing and front cover from extruded aluminium profile, angular version; no visible screws; designed for continuous lighting systems, 90° angle connectors for flexible system design; surface powder coated; suitable for wall mounting; homogeneous wall or ceiling illumination through uniform direct/indirect light distribution; HPO (High Performance Opal) cover for uniform illumination; or with specially computed, asymmetrical lens for homogeneous lighting intensity (installation optionally for floor or ceiling illumination); energy-efficient LEDs with very good colour rendering; optionally JUST 26 spotlight module can be installed

ES Cuerpo de lámpara y cubierta frontal de perfil extrusionado de aluminio, versión poligonal; sin tornillos visibles; diseñado para sistemas de iluminación continuos, conectores angulares de 90° para el montaje flexible del sistema; superficie con recubrimiento de pintura en polvo; apropiada para montaje pared; iluminación homogénea de la pared o bien del techo mediante distribución uniforme directa/indirecta de la luz; difusor opal de alta calidad que proporciona una iluminación uniforme; o con lente asimétrica de cálculo especial para intensidades luminosas homogéneas (montaje para la iluminación del suelo o del techo); LEDs de alta eficiencia que proporcionan una alta reproducción cromática; compatible con inserto de foco JUST 26

Quickinfo

3000K, 4000K, TW
 CRI ≥ 90, 3 SDCM
 up to 117m/W
 L90 @ 50 000h
 non DIM, DALI-2

Types

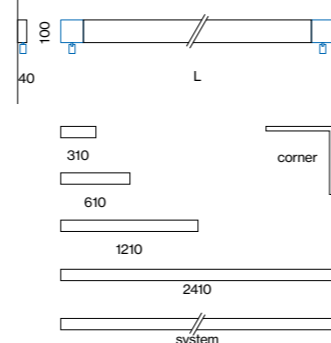

Colours



Light distributions

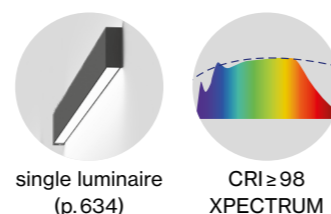
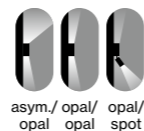

Order options

COLOUR TEMPERATURE	
3000K	5
4000K	6
tunable white 2700–5000K*	D

*available from L 1210 mm | DALI-2 DT8

CONTROL	
non DIM	1
non DIM/switch (only spotlights)	2
DALI-2	3
DALI-2/switch (only spotlights)	4

MATERIAL COLOUR	
○ pure white RAL 9010	7
● jet black RAL 9005	8

SPOTLIGHT ALIGNMENT	
left	B
right	C

spotlight(s) only with 3000K

Options on request

COLOUR RENDERING INDEX
 CRI ≥ 98 XPECTRUM

COLOUR TEMPERATURE
 2700K

MATERIAL COLOUR
 special colours

Light distributions

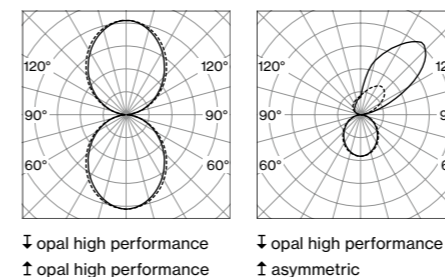

LUMINOUS FLUX value calculated for
 CRI ≥ 90, colour white, cover opal

LINEA system wall



↓ OPAL HIGH PERFORMANCE / ↑ OPAL HIGH PERFORMANCE

SYS. POWER	COLOUR TEMP.	LUMINOUS FLUX	L (mm)	ORDER CODE
14.7W	3000K	↓ 648/± 648lm	310	058-61411::↓↑AH
	4000K	↓ 715/± 715lm		
29.3W	3000K	↓ 1300/± 1300lm	610	058-61421::↓↑AH
	4000K	↓ 1430/± 1430lm		
59W	3000K	↓ 2590/± 2590lm	1210	058-61441::↓↑AH
	4000K	↓ 2860/± 2860lm		
111W	3000K	↓ 5190/± 5190lm	2410	058-61481::↓↑AH
	4000K	↓ 5720/± 5720lm		
29.3W	3000K	↓ 1300/± 1300lm	633x633	058-61111::↓↑AH
	4000K	↓ 1430/± 1430lm		
29.3W	3000K	↓ 1300/± 1300lm	633x633	058-61121::↓↑AH
	4000K	↓ 1430/± 1430lm		



↓ OPAL HIGH PERFORMANCE / ↑ ASYMMETRIC

SYS. POWER	COLOUR TEMP.	LUMINOUS FLUX	L (mm)	ORDER CODE
14.7W	3000K	↓ 648/± 821lm	310	058-61411::↓↑AA
	4000K	↓ 715/± 906lm		
29.3W	3000K	↓ 1300/± 1640lm	610	058-61421::↓↑AA
	4000K	↓ 1430/± 1810lm		
59W	3000K	↓ 2590/± 3280lm	1210	058-61441::↓↑AA
	4000K	↓ 2860/± 3620lm		
111W	3000K	↓ 5190/± 6570lm	2410	058-61481::↓↑AA
	4000K	↓ 5720/± 7250lm		
29.3W	3000K	↓ 1300/± 1300lm	633x633	058-61111::↓↑AA
	4000K	↓ 1430/± 1430lm		
29.3W	3000K	↓ 1300/± 1300lm	633x633	058-61121::↓↑AA
	4000K	↓ 1430/± 1430lm		



↓ OPAL HIGH PERFORMANCE / 1 SPOTLIGHT

SYS. POWER	COLOUR TEMP.	LUMINOUS FLUX	L (mm)	ORDER CODE
29.3W	3000K	↓ 1300/± 1300lm	710	058-61421::↓↑VH
	4000K	↓ 1430/± 1430lm		
59W	3000K	↓ 2590/± 2590lm	1310	058-61441::↓↑VH
	4000K	↓ 2860/± 2860lm		
111W	3000K	↓ 5190/± 5190lm	2510	058-61481::↓↑VH
	4000K	↓ 5720/± 5720lm		

spotlight alignment left or right

Accessories

END CAPS	
TYPE	ORDER CODE
end caps (pair)	050-254010

CONNECTOR	
TYPE	ORDER CODE
linear connector (1 piece)	050-2551100
linear connector (10 pieces)	050-2551100.10

THROUGH WIRE	
TYPE	ORDER CODE
3 × 1.5 mm ² (non DIM, 10 pieces)	004-90003
5 × 1.5 mm ² (DALI-2, 10 pieces)	004-90005

Bedroom
Visualisation



SNS Headquarters
Moscow, RU –
by ABD Architects with lighting
design by Light & Design

